



InstaShow™ S

User Manual

Copyright

Copyright © 2020 by BenQ Corporation. All rights reserved. No part of this publication may be reproduced, transmitted, transcribed, stored in a retrieval system or translated into any language or computer language, in any form or by any means, electronic, mechanical, magnetic, optical, chemical, manual or otherwise, without the prior written permission of BenQ Corporation.

Disclaimer

BenQ Corporation makes no representations or warranties, either expressed or implied, with respect to the contents hereof and specifically disclaims any warranties, merchantability or fitness for any particular purpose. Further, BenQ Corporation reserves the right to revise this publication and to make changes from time to time in the contents hereof without obligation of BenQ Corporation to notify any person of such revision or changes.

This user manual aims to provide the most updated and accurate information to customers, and thus all contents may be modified from time to time without prior notice. Please visit www.benq.com for the latest version of this manual.

The illustrations and the images in this guide are for your reference.

BenQ ecoFACTS

BenQ has been dedicated to the design and development of greener product as part of its aspiration to realize the ideal of the “Bringing Enjoyment 'N Quality to Life” corporate vision with the ultimate goal to achieve a low-carbon society. Besides meeting international regulatory requirement and standards pertaining to environmental management, BenQ has spared no efforts in pushing our initiatives further to incorporate life cycle design in the aspects of material selection, manufacturing, packaging, transportation, using and disposal of the products. BenQ ecoFACTS label lists key eco-friendly design highlights of each product, hoping to ensure that consumers make informed green choices at purchase. Check out BenQ's CSR Website at <http://csr.BenQ.com/> for more details on BenQ's environmental commitments and achievements.



Table of contents

Copyright	2
Disclaimer	2
BenQ ecoFACTS	2
Introduction	5
Product features	6
Package content	7
Product specification	8
Overview	9
Button	9
Host	9
LED indicators of the Button and the Host	10
Installation	11
Environment check	11
Assembling the Host	12
Setting up the Host	12
Attaching the Host to the ceiling	12
Attaching the Host to a ceiling mount.....	13
Placing the Host on a table	13
Installing the Host on the wall or trolley	15
Positioning the Host antennas	16
For ceiling installation	16
For ceiling mount installation	16
For table placement	17
Connecting the HDMI cable and power	17
Assembling the adapter	18
Connecting the HDMI cable.....	19
Power supply via a power adapter	19
LAN connection	20
Setting up and powering a Button	20
Using Cable USB A(F) to USB A(M)	23
Pairing a Button and Host	24
When the Host is placed on a table	24
Storing Buttons and USB cable in the cradle	26
Resetting a Host	26
Resetting a Button	27
Enabling network standby mode	28
Starting and stopping presentations	29
Getting ready	29
Starting presentation	29
Idle presentation	30
Split screen presentations	31
Starting a split screen presentation	31
Switching from a split screen to a full screen presentation	32
Presenting with mobile devices	32
Touch back	34
Web management	35
Accessing the web management interface	35

Logging into the web management interface via direct connection	35
Logging into the web management interface via LAN	37
Logging into the web management interface via a wireless network	37
Getting started	39
Top command buttons	39
Function bar	39
Main column	40
Information	40
WAN	42
Wireless Network	43
Pairing.....	49
Advance Setting	51
Scheduling.....	56
Tool	57
Legal Announcement	66
Troubleshooting	67

Introduction

InstaShow™ S (or “the product” in this document) is a wireless device for corporate meeting rooms. Users expect devices to respond instantly, apps to launch and to control at their fingertips, and information to be available on demand. The product bypasses the complicated steps of IP addresses, driver installation, app execution, setting selection, etc. to quickly deliver professional, stable visual quality for teams to collaborate freely and confidently. The product is an unique all-hardware solution without software issues for universal compatibility and display flexibility.

A standard product set consists of an InstaShow™ S Host (or “Host” in this document) and two InstaShow™ S Buttons (or “Buttons” in this document). Depending on the location where you buy the product, the software of the base unit can be different. You can buy additional InstaShow™ S Button kits if needed.



• “InstaShow™ S” will hereinafter be referred to as “the product” in this document.

• “InstaShow™ S Host” will hereinafter be referred to as “Host” in this document.

• “InstaShow™ S Button/Buttons” will hereinafter be referred to as “Button”/“Buttons” in this document.



Your product complies with the local wireless regulations and the warranties are valid in the country/region where the product is purchased. Using the product outside the purchased country/region does not guarantee the wireless functionalities. And modification of any part of the product will void the warranties.

Product features

The product is equipped with the following features:

Features	Description
True Plug & Play	Simply connect the product into your USB and HDMI ports, then push the button to start presenting immediately.
No Software	The product doesn't need any software installation or execution. There's no setup, configuration, or waiting for pop-ups to launch. Just plug into your PC or Mac and start presenting immediately.
Split Screen Presentations	Up to four users can simultaneously project their screen via the product in a dual-screen, 3-way or 4-way split screen configuration, so that you can view and reference multiple documents/videos at the same time during your presentation.
Auto Channel Selection	The product automatically selects the best wireless channel upon boot-up, ensuring smooth presentations in any environment.
Touch Back	When the Host is connected to a touchscreen display via its USB ports, you can use the touchscreen to control the screen of the PC that is presenting, allowing you to actively engage with the content that is being presented.
Screen Casting for Mobile Devices	Project your mobile device's screen wirelessly by connecting your mobile device to the Host via the InstaShare app or screencasting capabilities of your mobile device.
Wireless 802.11ac/n	The latest 802.11ac/n Wi-Fi guarantees extremely smooth wireless streaming without lag or buffering.
Video and Audio	The product's HDMI output supports up to 60Hz Full HD 1080p video and stereo sound without cable clutter or complicated driver selection.
Assured Performance	Peace of mind for consistent wireless presentation performance without relying on your PC.
Extended Desktop	Keep your presenter view, notes, and backup data on your laptop screen while presenting to the wireless screen with extended desktop in both Windows and OS X.



- Touch back via USB port is only supported for Windows-based PCs. Macs and mobile devices cannot be controlled via touch screens.
- Transmission distance depends on actual environment. Stated distance is based on line-of-sight measurement. Structures constructed of steel, wood, concrete, or brick may decrease transmission distance.
- According to regulatory restrictions in different regions of the world, Wi-Fi channels cannot be used in countries outside the purchased region.

Package content

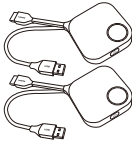

InstaShow™ S Buttons

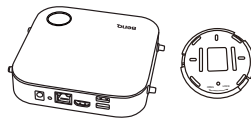

InstaShow™ S Host and Lid

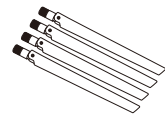

4 Antennas

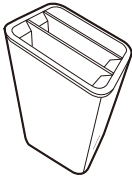

Cradle

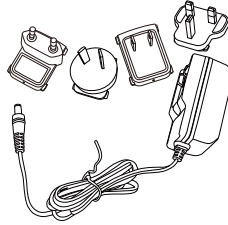

Adapter & Plugs

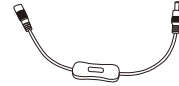

Extender Power Cable
(EU Countries Only)

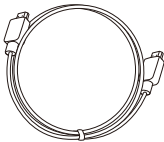

Cable: HDMI A(M) to A(M)

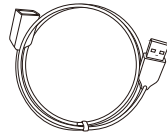

Cable: USB A(F) to USB A(M)



Screws & Rubber Foot

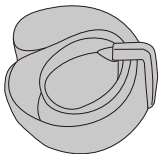

Velcro Strap

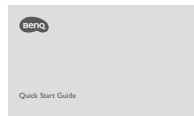

Quick Start Guide



Safety Statement



- Available accessories and the pictures shown here may differ from the actual contents and the product supplied for your region.
- Use original accessories to ensure compatibility.
- Always keep the product and accessories out of reach of children.

Product specification

Feature			
Color	Black		
Video outputs	HDMI 1.4, comply with HDCP		
Frame Rate	Up to 60fps depending on environment		
Output resolution	720x480, 720x576, 1280x720, 1920x1080, up to 3840x2160 (30Hz)		
Input resolution	Video: 480p, 576p, 720p, 1080p PC Timing: 640x480, 800x600, 1024x768, 1280x720, 1920x1080		
Number of simultaneous connections	32 pcs		
Audio	Stereo, Radio quality 16bits 48KHz		
Wireless transmission protocol	IEEE 802.11ac, 5GHz, 2T2R IEEE 802.11n, 2.4GHz, 2T2R		
Data rate wireless	Up to 867 + 300Mbps		
Frequency Band	2.4GHz, 5GHz		
Authentication protocol	WPA2 (WPAS-PSK (Pre-Shared key) / WPA2-Enterprise)		
Security (encryption)	AES 128 bit		
Support platform	Windows, MAC, Chrome. Any OS supporting HDMI standard 1.4		
Reach	Max. 15M between the Button and the Host		
Temperature range	Operating: 0°C to +40°C (+32°F to +104°F)		
	Storage: -10°C to +60°C (+14°F to +140°F)		
Humidity	Storage: 5% to 90% relative humidity, non-condensing		
	Operation: 10% to 80% relative humidity, non-condensing		
InstaShow™ S Button			
Cable	USB Type A, HDMI Cable	Power supply	DC 5V±10%, 0.5A
Reset button	x1	Power consumption	Normal: 2.5W
Split screen key	x1	Dimension	With cable: 81x291x24.2mm Without cable: 67x67x24.2mm
LED	Red (error) Green (Wi-Fi connected) Blue (presenting)	Weight	81g
InstaShow™ S Host			
Standby button	x1	Power supply	DC 12V±10%, 2A
Pairing key	x1	Power consumption	Normal: 24W
WAN	x1		
Video output	x1 HDMI 1.4 (video and audio)		
DC Power Jack	x1	Dimension (WxHxD) (not including rubber feet)	With antennas: 200x150x140mm Without antennas: 154x34x140mm
LED	Red (error) Green (ready for connection) Blue (presenting)	Weight (include antenna)	330g
Cradle			
Dimension	100.4x92.6x152mm	Weight	550g

Overview

Button

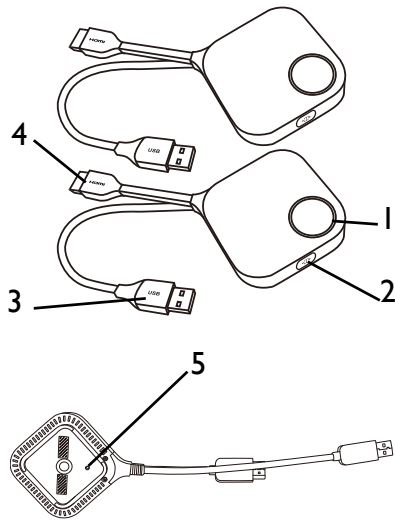

Bottom of a Button

1. **Present key with LED indicator**
Press to start or stop presenting.
2. **Split screen key**
Press to enable split screen presentations.
3. **USB 3.0 connector**
Connect to a computer or laptop.
4. **HDMI 1.4 connector**
Connect to a computer or laptop.
5. **RESET**
Poke the **RESET** hole to reset the device if the device stops responding. Refer to [Resetting a Host on page 26](#) for more information.

Host

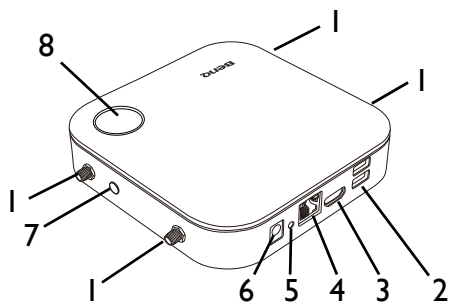

1. **Fixture parts for the Antennas**
Refer to [Assembling the Host on page 12](#) for more information.
2. **USB-A Ports**
Connect to a touchscreen display, mouse, or keyboard, to control the projected screen.
3. **HDMI port**
Connect to a display using a Cable HDMI A(M) to A(M).
4. **LAN port**
Allows users access to the web management interface through a direct or network connection.
5. **RESET**
Poke the **RESET** hole to reset the device if the device stops responding. Refer to [Resetting a Host on page 26](#) for more information.
6. **DC 2A port**
Connect to the supplied adapter extender power cable and adapter to power the Host.
7. **PAIRING key**
Press to pair with a Button.
8. **Standby button with LED indicator**
Press to turn the Host on and off.

9 Lid of the Host

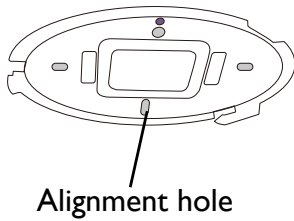

9. Lid

Refer to [Attaching the Host to the ceiling on page 12](#) for more information.

LED indicators of the Button and the Host

Please refer to the tables below for detailed indicator and status descriptions for the Button and the Host.

LED indicator on the Button	Status Description
Static blue	The device is presenting.
Flashing blue	The device is in the process of pairing
Flashing green	<ul style="list-style-type: none">• The device is starting up and connecting to the host.• The device is downloading the firmware.
Static green	The device is connected and working normally.
Flashing red	The device is unable to connect to a host.
Off	The device is powered off.
Quick flashing green	The device is upgrading the firmware.
Static white	The device is in network standby mode.

LED indicator on the Host	Status Description
Static blue	Connected device is presenting.
Flashing blue	The device is in the process of pairing.
Flashing green	<ul style="list-style-type: none">• The device is starting up.• The device is upgrading the firmware.
Static white	The device is in network standby mode.
Static green	The device is on and ready for connection.
Off	The device is powered off.

Installation

This section will guide you on how to prepare the unit before its initial use.

Environment check

Before installing your InstaShow™ S kit, check the environmental conditions.

1. Do not install the device near heat sources like radiators or direct sunlight, or in a site with excessive dust or humidity.
2. Ambient temperature conditions are listed as below. Maximum ambient temperature should be +40°C or 104°F. Minimum ambient temperature should be +0°C or 32°F. Storage temperature should be -10°C to +60°C (14°F to 140°F).
3. Humidity conditions are listed as below. For storage, the relative humidity should be 5% to 90% (non-condensing). For operation, the relative humidity should be 10% to 80% (non-condensing).

As the product works with different displays, the steps required to complete the installation may vary according to the actual environment and your display specifications. Follow the procedures below and refer to the specified sections for details.

1. Assemble the Host with the antennas. See [Assembling the Host on page 12](#) for details.
2. Connect the Host to the display and power properly. See [Connecting the HDMI cable and power on page 17](#) for details. Four installation methods are provided.
 - Attaching the Host to the ceiling
 - Attaching the Host to a ceiling mount
 - Placing the Host on a table
 - Installing the Host on the wall or trolley
3. Connect the Buttons to the desired devices and power properly. See [Setting up and powering a Button on page 20](#) for details.
4. Make sure that all the connected devices have been powered on. Press the source button of the display and make sure that the HDMI source has been transmitted. See [Pairing a Button and Host on page 24](#) for details.

Assembling the Host

Assemble the Host with four antennas by turning the antennas clockwise (right) and counterclockwise (left) to fasten them tightly.

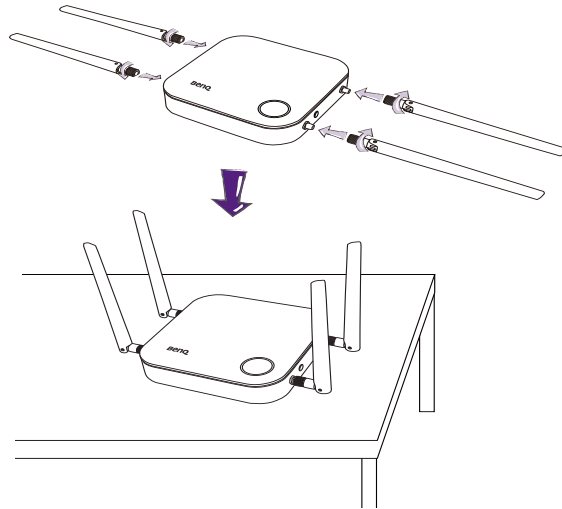

Setting up the Host

You are provided with four different ways to position the Host. The total weight of the Host Unit is 330g.

Attaching the Host to the ceiling

1. Place the lid on the ceiling and locate the alignment hole.
2. Use the screws provided to lock the lid to the ceiling.
3. Lock the first hole (1).
4. Follow the instruction in the illustration below to lock the other holes (2-4).
5. Rotate the Host counterclockwise to affix the Host to the lid.

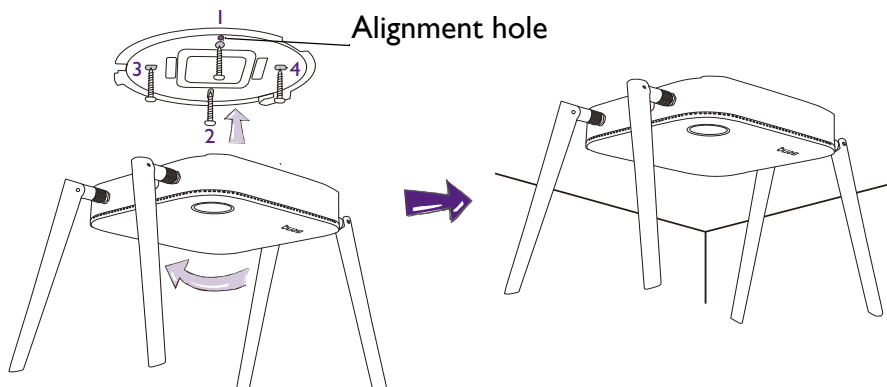

- Please only use the screws (M3*I6 tapping screw) provided with the kit to mount the Host to the ceiling.
- Please see [Positioning the Host antennas on page 16](#) for guidelines on positioning the antenna to maximize signal reception.

Attaching the Host to a ceiling mount

If the display is mounted on the ceiling:

1. Attach the Host to the ceiling mount using the provided velcro strap.
2. Fix the Host to the mounting holder.
3. Use the supplied velcro to fix the mounting holder and the Host to the ceiling mount as shown in the illustration.

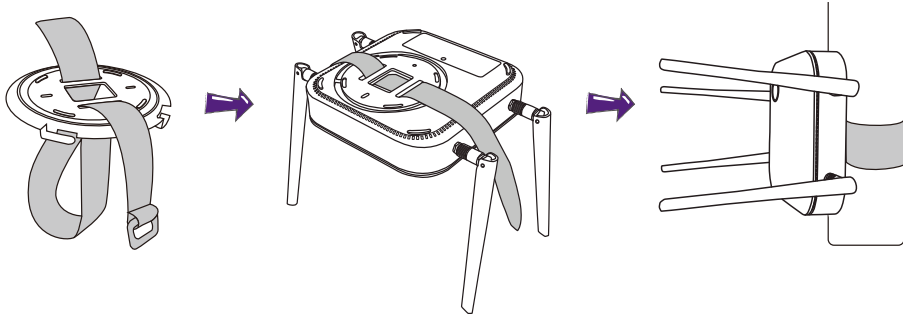

- Please only use the velcro strap (300(L)mm*25(W)mm) provided with the kit to mount the Host to a ceiling mount.
- Please see [Positioning the Host antennas on page 16](#) for guidelines on positioning the antenna to maximize signal reception.

Placing the Host on a table

If your display is placed on a table, first attach the lid of to the Host in the following the process described below:

1. Align the lid over the bottom of Host so that the triangle on the bottom side of the lid is aligned to the triangle in the lid compartment, then insert the lid into the lid compartment.

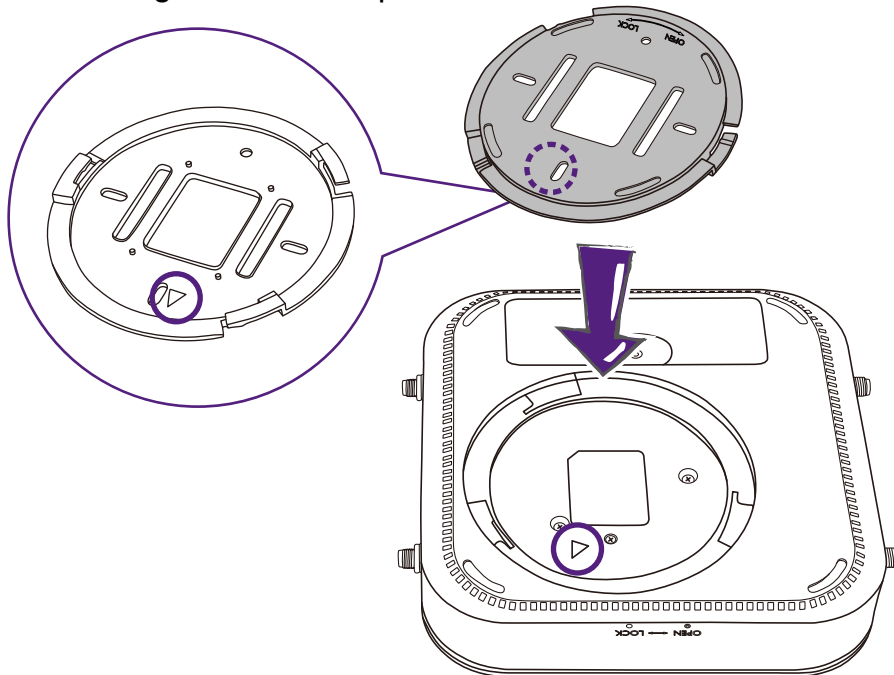

2. Turn the lid counter-clockwise until it clicks into place.

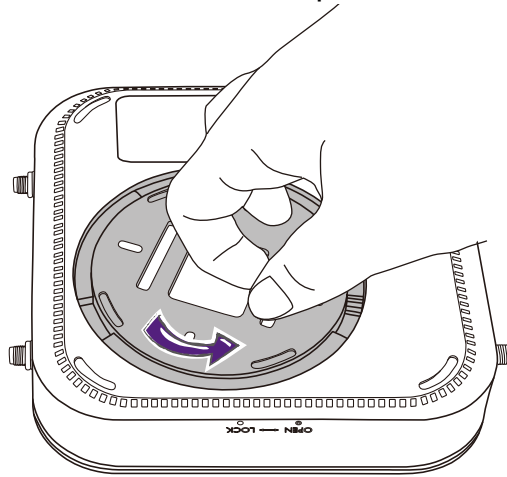

3. When the lid is correctly installed on the Host the alignment hole on the lid should be pointed to the **LOCK** print at the front side of the Host.

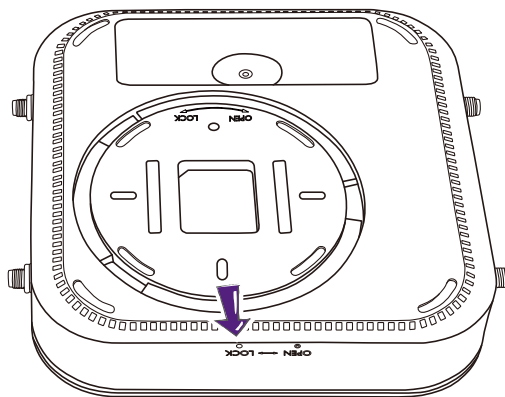

4. Attach the rubber feet to the recesses on the lid and put the Host right next to the display.

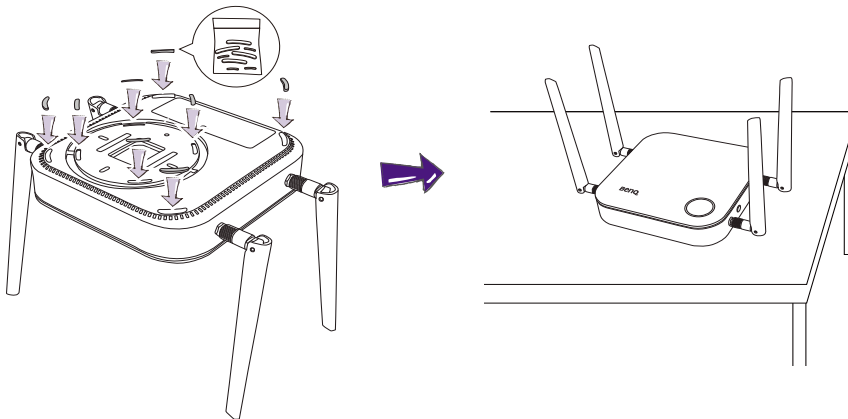

- Please only use the rubber foot provided with the kit to attach to the Host.
- Please see [Positioning the Host antennas on page 16](#) for guidelines on positioning the antenna to maximize signal reception.

Installing the Host on the wall or trolley

If you need to install the Host near a display:

1. Stick double-sided tape to the lid of the Host.
2. Affix the Host on the wall near the display.
3. Keep the antennas away from any signal obstructions.

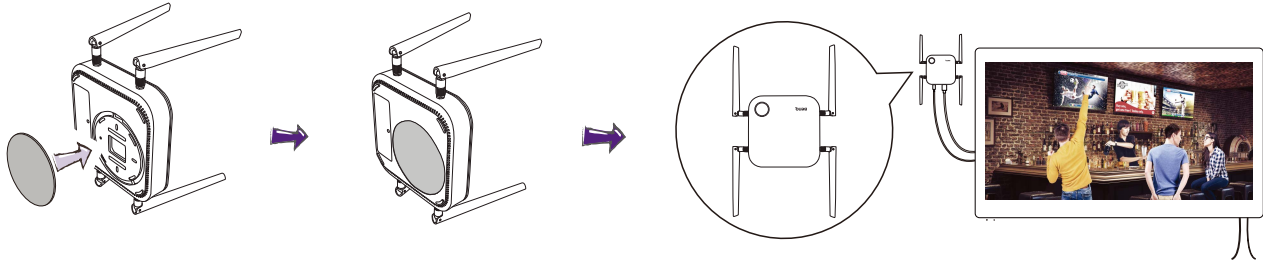

You can also place the Host on a mobile display trolley. See the illustration.

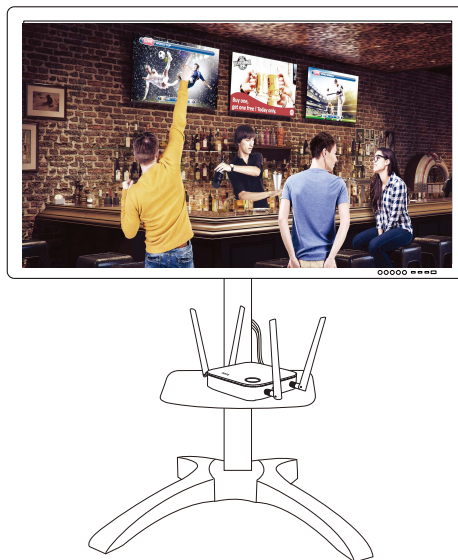

- Please only use double-sided sponge tape on the lid of the Host.
- Please wait 24 hours after you attach the double-sided sponge tape to the lid of the Host.

Positioning the Host antennas

Once you have properly installed the Host, follow the guidelines below to position the antennas to maximize signal reception:

For ceiling installation

Position the antennas so that they are both pointed downwards at an angle roughly perpendicular to the ceiling:

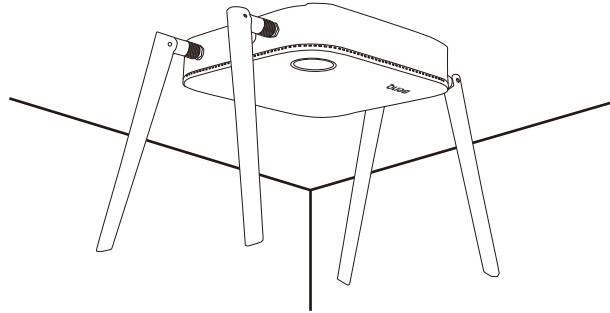

For ceiling mount installation

- Position the antennas so that they are both point either upwards or downwards roughly parallel to the ceiling mount:

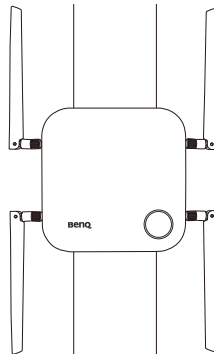

- If you encounter bad signal reception after initial use of the Host you can manually adjust the antennas so that they tilt at a slight angle to maximize signal reception. When doing so, avoid tilting the antennas toward the ceiling mount:

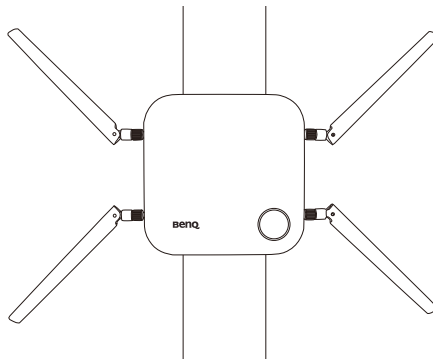

- Avoid positioning the antennas in a horizontal manner, this may result in a weak signal reception:

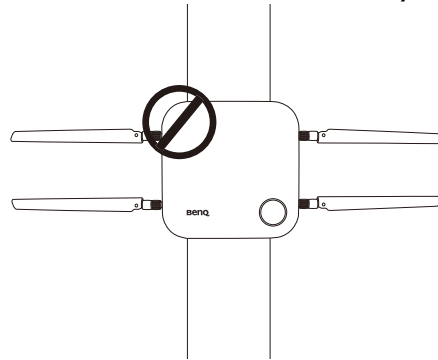

- If the Host is attached to a metallic ceiling mount ensure that the antennas are at least 3 cm away from the metal portion of the ceiling mount:

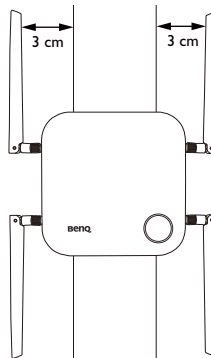

For table placement

Position the antennas so that they are both pointed upwards roughly perpendicular to the table:

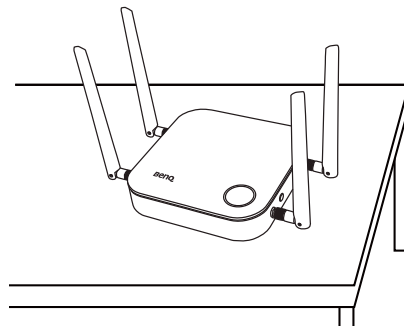

Connecting the HDMI cable and power

Once the Host has been positioned properly near the display, connect the HDMI cable and power to ensure signal transmission.

Assembling the adapter

Every adapter provided in the box includes a plug socket and plugs based on the region in which you purchased the product. Below are images of the standard American, standard European, standard Australian, and standard UK plugs:

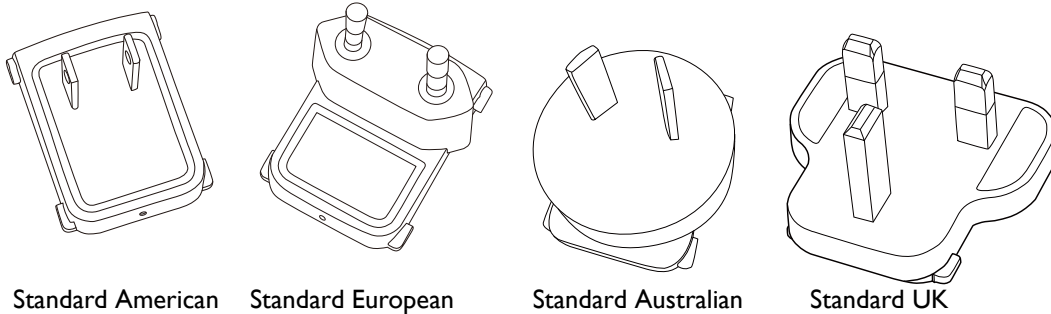

To connect the plug of your choice, follow the steps below.

1. Align and insert the plug into the adapter.
2. Push the plug all the way in until it clips into place.

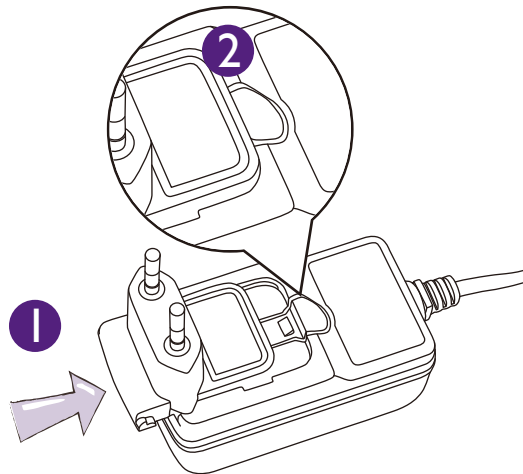

To disconnect the plug, follow the steps below.

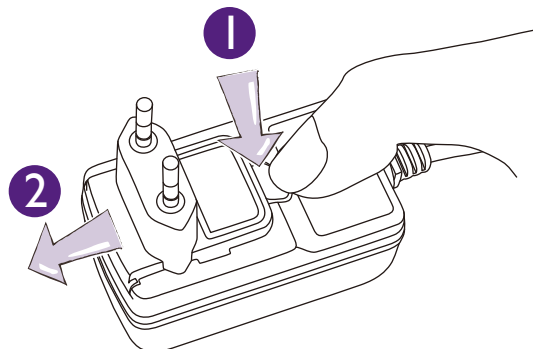

1. Push the latch in the middle.
2. Detach the plug by pushing it outward and remove the plug.

Connecting the HDMI cable

Connect the HDMI cable to the HDMI out jack of the Host and the HDMI input jack of the projector.

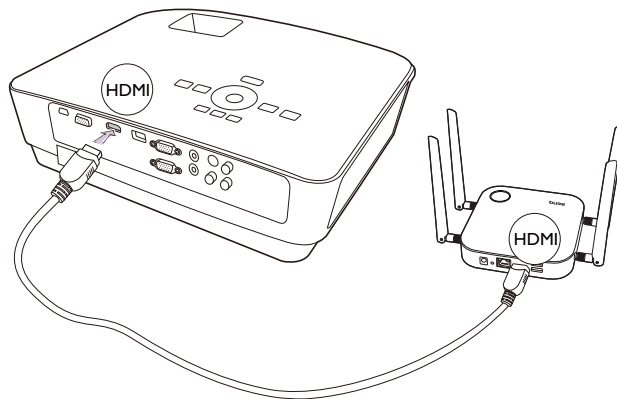

Power supply via a power adapter

(If an extender power cable is included in the package)

Connect the male connector of the extender power cable to the power jack of the Host, then connect the supplied power adapter to the female connector of the extender power cable, and then plug the other end of the power adapter into a wall socket. Once the connection is set up press the power switch on the extender power cable to supply power to the Host, the LED indicator on the standby button of the Host lights up static green when the power is supplied.

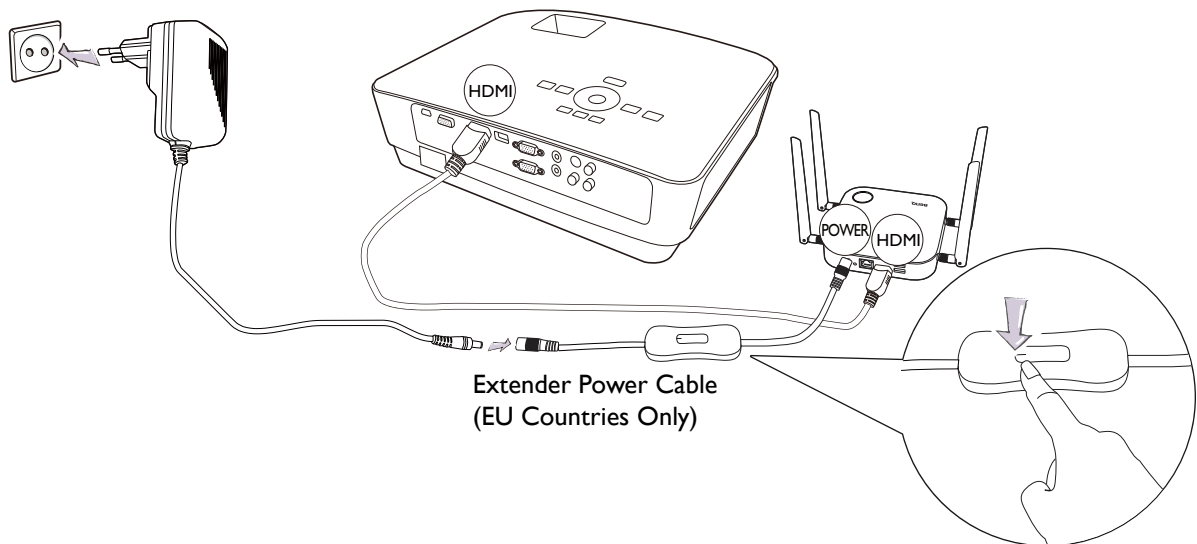

(If no extender power cable is included in the package)

Connect the supplied power adapter to the power jack of the Host, and then plug the other end of the power adapter into a wall socket. The LED indicator on the standby button of the Host lights up static green when the power is supplied.

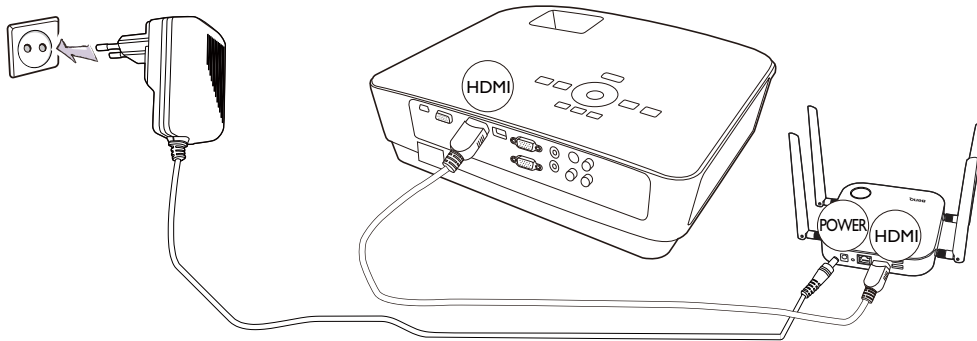

For BenQ IFP (Interactive Flat Panel) products, please have power supplied via a power adapter.



Do not keep the device powered on all the time. For better performance, power off the device for 30 minutes in every 24 hours then restart it.

LAN connection

The Host can be connected to a local network or directly to a laptop. The LAN connection can be used to configure your product and update the software. Insert a network cable with RJ-45 connectors into the LAN port and connect the other side to a LAN.

Setting up and powering a Button

1. Connect the Button's HDMI and USB jacks to the corresponding inputs of a laptop. See the illustration.

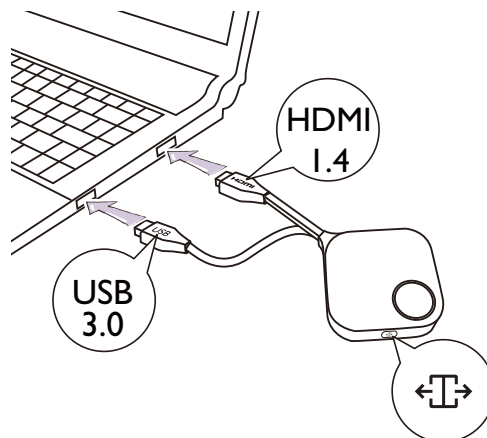

2. The LED indicator of the Button will flash green while the Button is starting up.

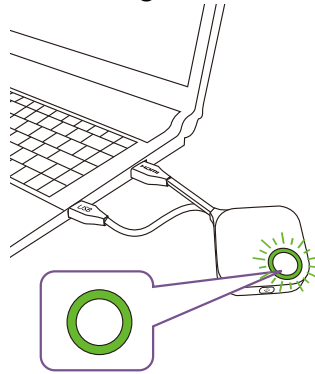

3. When the Button is ready to present, the LED indicator will turn solid green. Press the Present key when the LED indicator turns green.

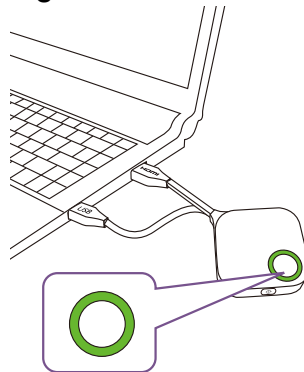

- If the Button encounters problems while pairing with the Host during startup the LED indicator will flash red. Repeat the previous the process again until the LED turns solid green. See [LED indicators of the Button and the Host on page 10](#) for more information on LED behavior.
- Handle the Button cable with care. Rough handling might cause defects.
- Pull/Push the plug instead of the cable when inserting or removing Buttons.

If you purchase an additional Button (via a Button Kit), please follow the process described below:

1. Follow the pairing instructions described in [Pairing a Button and Host on page 24](#).
2. Connect the Button's HDMI and USB jacks to the corresponding inputs of a laptop. See the illustration.

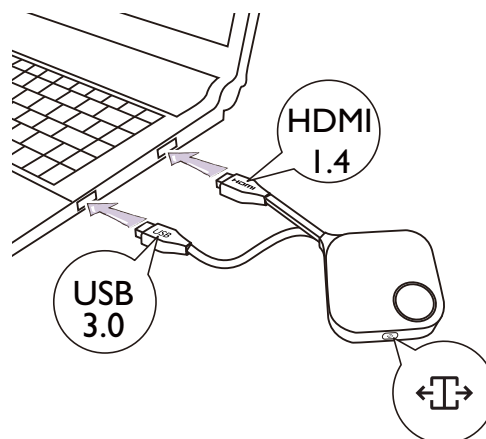

3. The LED indicator of the Button will flash green while the Button is starting up.

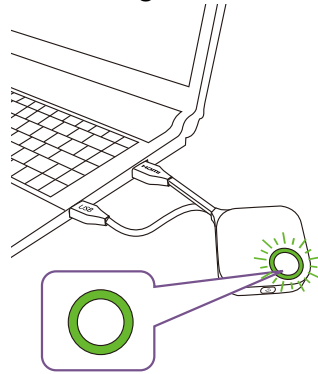

4. When the Button is ready to present, the LED indicator will turn solid green. Press the Present key when the LED indicator turns green.

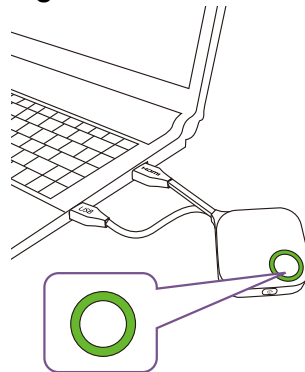

- Handle the Button cable with care. Rough handling might cause defects.
- Pull/Push the plug instead of the cable when inserting or removing Buttons.

Using Cable USB A(F) to USB A(M)

A USB cable is provided for MacBook and Windows laptop users.

1. Insert the HDMI cable of the Button to the HDMI converter of your laptop.
2. Connect the cable USB A(F) to your laptop.
3. Connect the Button's USB jack to the Cable USB A(M).

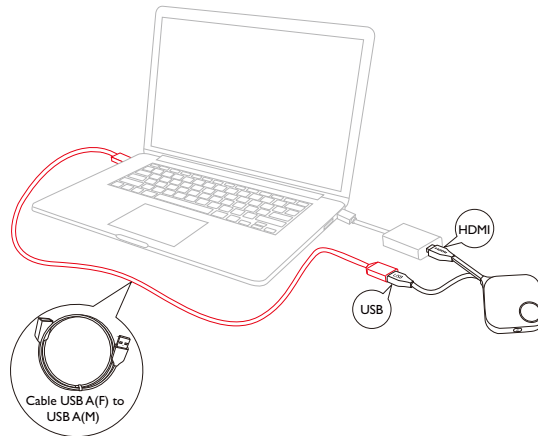

Make sure your own HDMI converter is workable.

Pairing a Button and Host

A product set includes a Host and two Buttons, which are paired before shipment. In such a case, you don't need to pair them again. However, if you buy two or more product sets, and you want to pair a Button with a different Host, you need to follow the instruction below. If you buy an additional Button kit, and you want to pair the new Buttons with your Host, you need to follow the instruction below as well.

When the Host is placed on a table

1. Make sure your Host is ready with power supply. Connect the Button's HDMI and USB jacks to the corresponding inputs of a laptop.

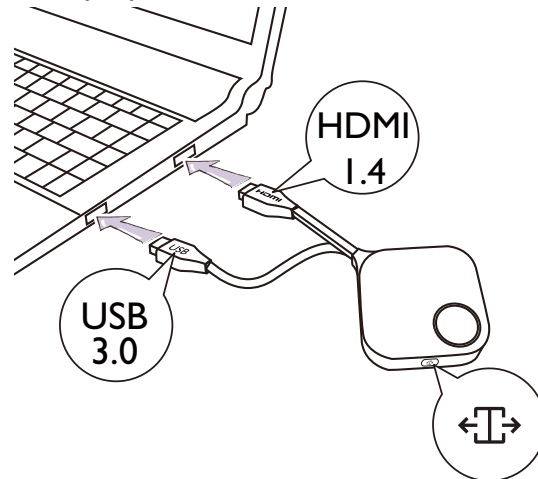

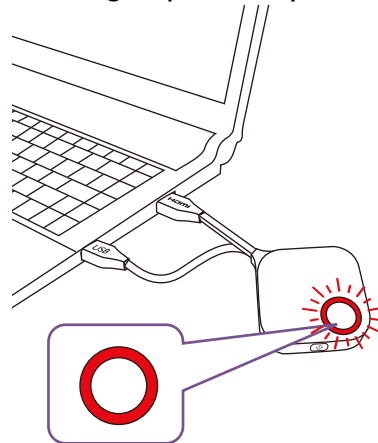

2. When the new Button is connected to the laptop, the LED indicator of the Button will flash red. The Button is in pairing mode, waiting to pair with your Host.

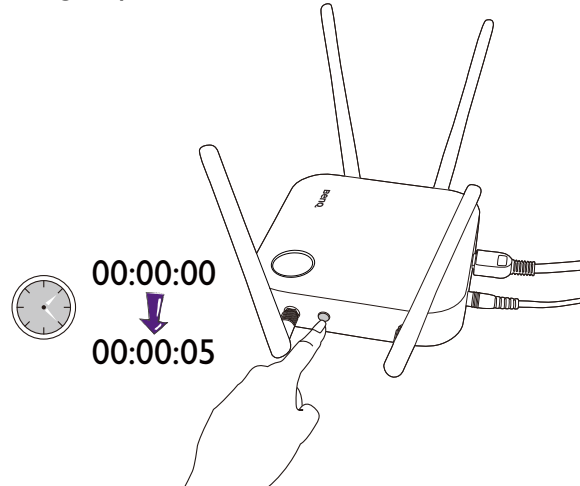

If a Button nearby has been paired with a Host before, it will turn static green.

3. Press the **PAIRING** key of the Host for five seconds, the LED indicator of the Host will blink blue for two minutes, waiting to pair with a Button.



 If the Host is attached to the ceiling so that it is not easy to press the **PAIRING** key, please use the pairing process in the web management interface. Refer to [Pairing on page 49](#) for information.

4. Press the split screen key on the side of the Button for five seconds. The LED indicator of the Button will blink blue for about 10 seconds. The pairing process is ongoing. The “Pairing in progress” message will be shown on the screen.

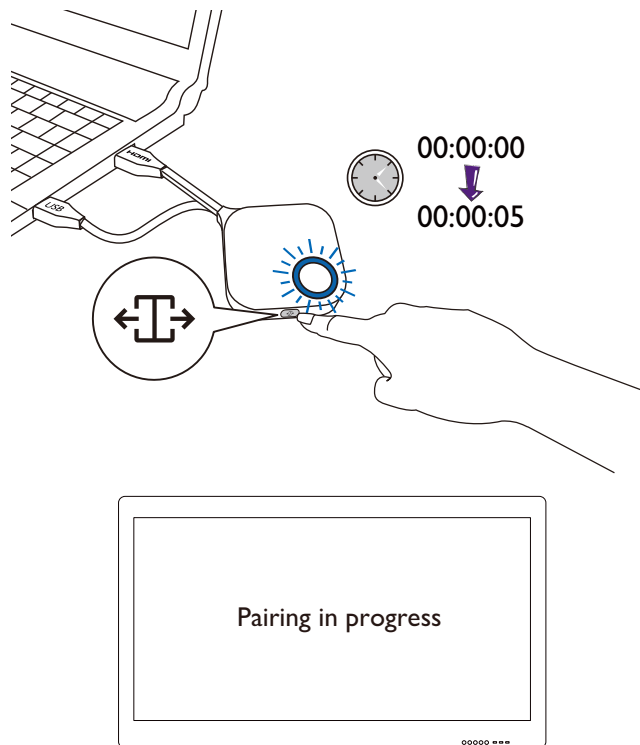

 The images are for reference only. Each product has different serial number.

5. The LED indicator of the Button turns static green and a “Pairing complete” message will be shown when the Host and Button are successfully paired.

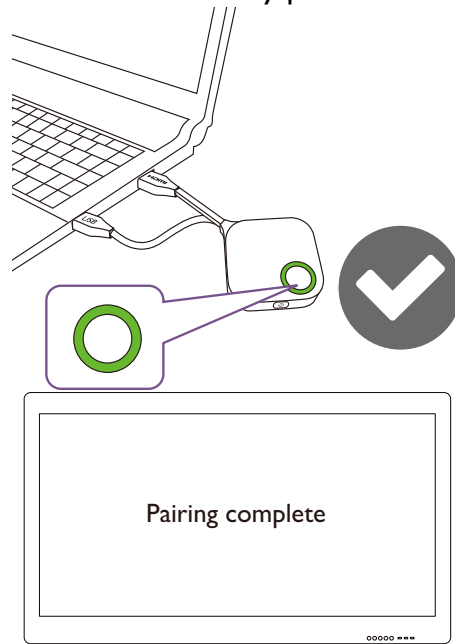

The maximum number of Buttons you can pair with one Host is 32.

Storing Buttons and USB cable in the cradle

You are provided with two different ways to store the Buttons in the cradle. Place the Buttons in the cradle vertically (1) or horizontally (2). See the illustrations.

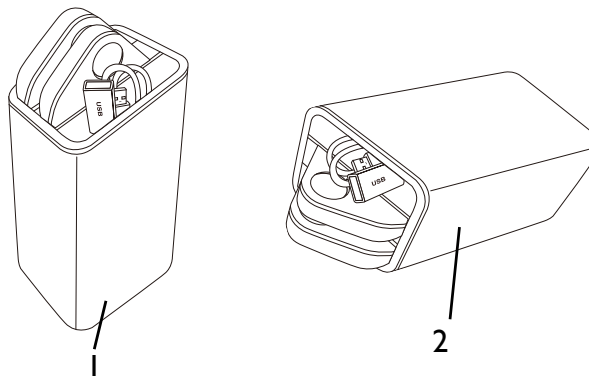

Resetting a Host

Resetting a Host allows you to return the Host to its original factory settings. You may want to reset the Host because of either one of the following reasons:

- You want to clear the web management interface of all changes made to its configurations, such as pairing information, passwords, SSID, Frame Rate, etc. and return it back to its default settings. Refer to [Web management on page 35](#) for more information.
- You are unable to access the web management interface (for instance due to an altered or lost password).

Reset the Host using the following steps:

1. Connect the power port on the Host to a power source and wait for at least 90 seconds.



After the Host has been connected to a power source for at least 90 seconds, the Host LED may indicate any one of the statuses described in [LED indicators of the Button and the Host](#). As long as the Host has been connected to a power source for at least 90 seconds, you may proceed to the next step of the resetting process regardless of the status of the Host LED.

2. Poke the **RESET** hole at the rear of the Host with a pin for at least 5 seconds.

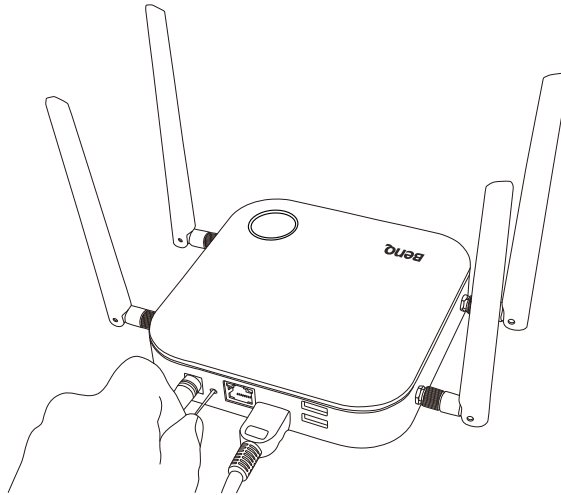

3. The Host LED will begin quick flashing red (flash red twice every second) for 10 seconds, then light up static white for 3 seconds, indicating that the Host is resetting.
 4. Once the Host LED lights up static green the resetting process is complete.
-



Do not disconnect the Host from its power source at any time during the resetting process.

Resetting a Button

Resetting a Button allows you to return the Button to its original factory settings. You may want to reset a Button because of either one of the following conditions:

- You purchased an additional Button (via a Button Kit) which has not been paired to a Host.
- A Button that was included in the original package has been paired to a different Host (one which was not originally included with the Button in the package), and you want to quickly pair it back to its original Host.
- A Button that was included in the original package has been paired to a different Host (one which was not originally included with the Button in the package), and you want to re-pair the Button to its original Host while the Host is not powered on.

Reset a Button using the following steps:

1. If the original Host is powered on, place the Button within range of the original Host and ensure the LED on the Host is static green.

2. Connect the USB 3.0 connector on the Button to a powered on laptop and wait for at least 30 seconds.



After the Button has been connected to a powered on laptop for at least 30 seconds, the Button LED may indicate any one of the statuses described in [LED indicators of the Button and the Host](#). As long as the Button has been connected to a powered on laptop for at least 30 seconds, you may proceed to the next step of the resetting process regardless of the status of the Button LED.

3. Poke the **RESET** hole at the bottom of the Button with a pin for at least 5 seconds.

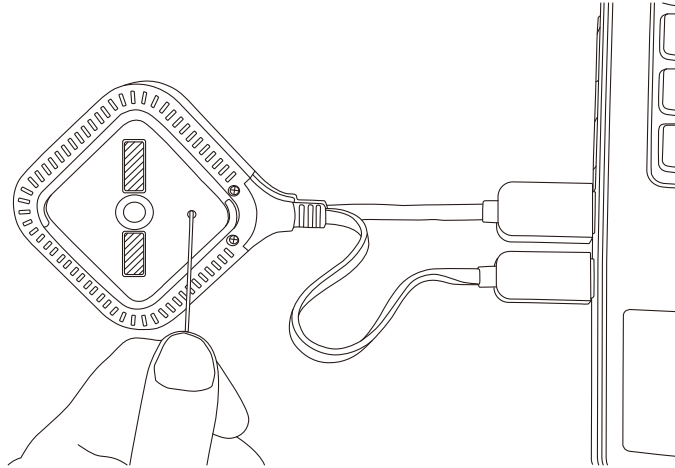

4. The Button LED will begin quick flashing red (flash red twice every second) for 10 seconds, then light up static white for 2 seconds, indicating that the Button is resetting.
5. Once the Button LED lights up static green the resetting process is complete.



Do not disconnect the Button from its power source at any time during the resetting process.

Enabling network standby mode

You can set the Host to enter network standby mode after a period of inactivity. To set the time of inactivity, go to **Web Management > Advance Setting > Network Standby**. See [page 55](#) for more information.

To enable network standby mode, do one of the following:

- wait for the Host to enter network standby mode automatically if no wireless devices (e.g., a Button, a mobile device, or a laptop) being connected to the Host's SSID and no data (from any USB devices such as a mouse, a keyboard, or from touch back function) being transmitted to the Host within the set time.
- if there is no wireless devices being connected to the Host's SSID within the set time, press the standby button on the Host to enable network standby mode immediately.

The LED indicator on the Host lights up static white when it is in network standby mode.

The network standby mode is disabled when

- a wireless device is connected to the Host's SSID; or
- data (from any USB devices such as a mouse, a keyboard, or from touch back function) is transmitted to the Host; or
- you press the standby button on the Host.

Starting and stopping presentations

This section will guide you on how to start and stop a presentation using the product.

Getting ready

Make sure that all the connected devices have been powered on and ready for the presentation.

As the product could work with different projectors, IFPs, TVs, or monitors with standard HDMI ports, the steps required to start a presentation may vary according to the actual environment and your display specifications. Follow the procedures below and refer to the specified sections for details.

1. To start a presentation, see [Starting presentation on page 29](#) for details.
2. To stop a presentation, see [Idle presentation on page 30](#) for details.
3. To start a split-screen presentation, see [Split screen presentations on page 31](#) for details.
4. To start a presentation with a mobile device, see [Presenting with mobile devices on page 32](#) for details.
5. To control presentations via a touchscreen displays or mouse/keyboard see [Touch back on page 34](#) for details.

Starting presentation

1. Make sure power is supplied to the Host. See [Connecting the HDMI cable and power on page 17](#) for more information.
2. Choose the HDMI source corresponding to the Host on the display. You will see the Guide screen.



3. Please follow the instruction on the Guide screen to supply power to the Button. You can also see [Setting up and powering a Button on page 20](#) for more information. The LED indicator on the Button is static green when the Button is connected and working properly.
4. To start a presentation, press the Present key.

5. The device starts presenting, and the LED indicator of the Button turns static blue.

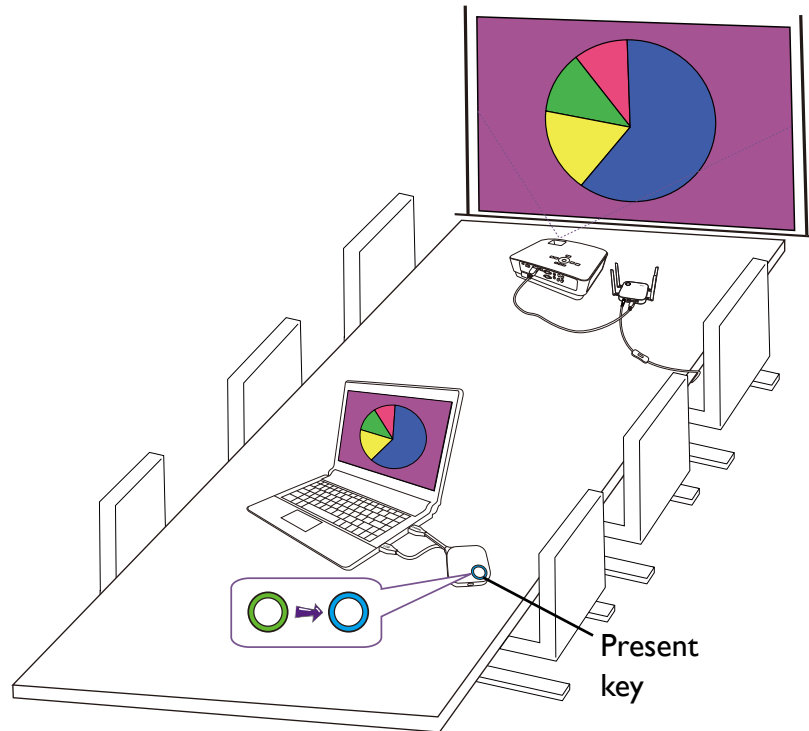

- Make sure the transmission distance between the Button and Host is within 15M and with no obstacles.
- The product supports MacBooks and Windows laptops to mirror an extended desktop.

Idle presentation

1. To stop a presentation, press the Present key.
2. The device stops presenting, and the LED indicator of the Button turns green.
3. Users can press the Present key to return to the presentation.

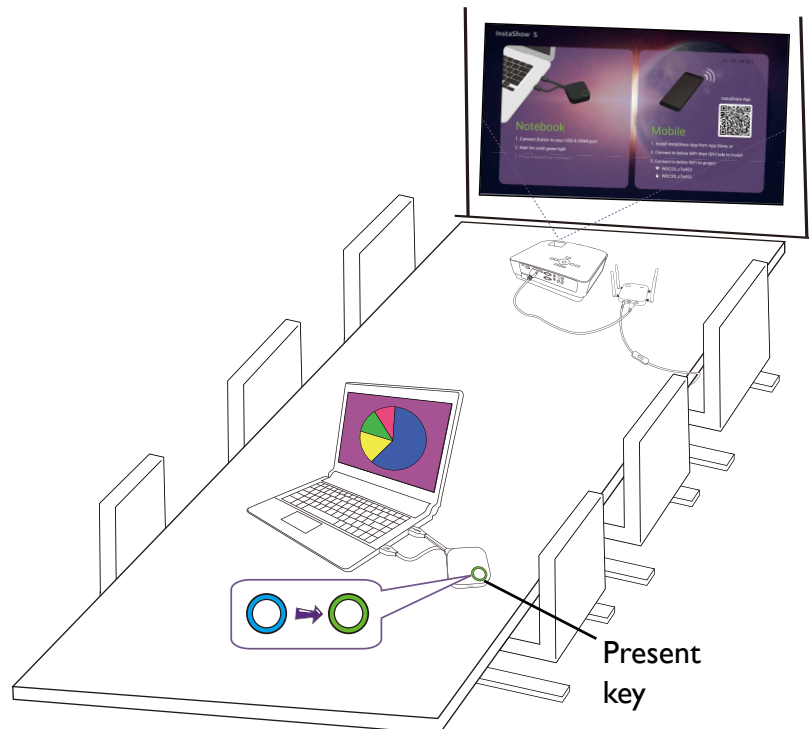

Split screen presentations

The product allows up to 4 users to present simultaneously in a split screen orientation.

Starting a split screen presentation

1. Connect a Button to each computer that will be presenting in the split screen presentation. See [Setting up and powering a Button on page 20](#) for more information.



Make sure that all Buttons have already been paired to the Host projecting the presentation. See [Pairing a Button and Host on page 24](#) for more information.

2. Start a normal presentation using one of the Host buttons. See [Starting presentation on page 29](#) for more information.
3. Press the split screen button on the Host that started the presentation to enable split screen presentations.

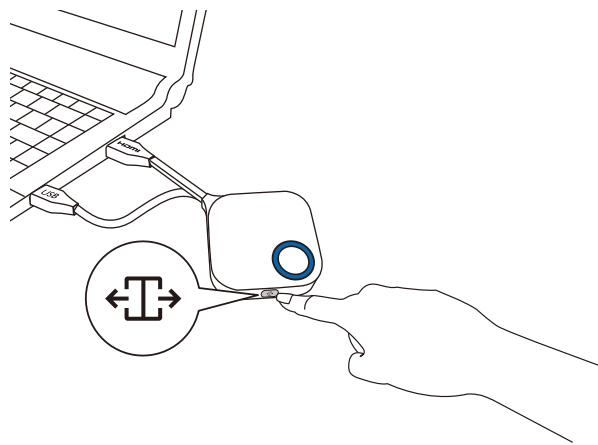

4. Once a notification appears on-screen indicating that the split screen function has been enabled, press the Present key on the Button of the second computer that wants to join the split screen presentation.
5. Repeat step 4 for all other users that want to join the split screen presentation.



- Only up to 4 users are simultaneously supported in a split screen presentation.
- The layout of the split screen presentation will be dictated by the amount of users in the presentation.
- If split screen is not enabled by the initial Button, all subsequent connections by other Buttons will be full screen presentations.

Switching from a split screen to a full screen presentation

Once in a split screen presentation you can switch to a full screen presentation of any of the participant's screen by pressing the split screen button on the Button of the computer that wants to present in a full screen.

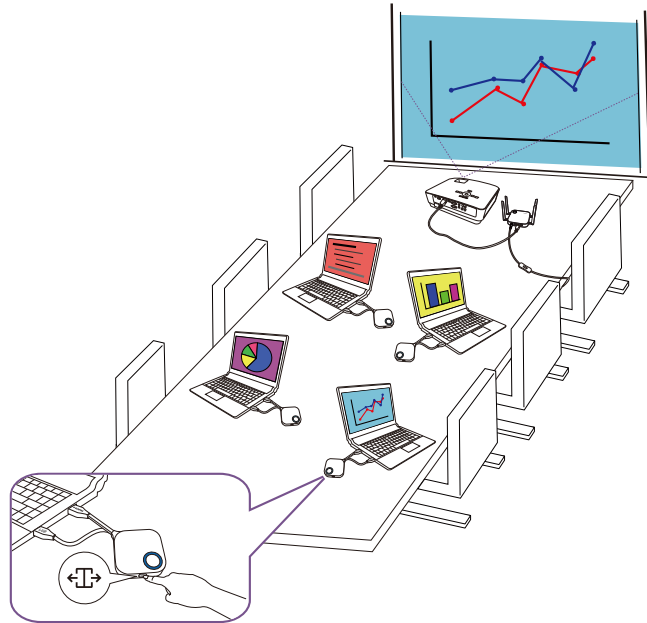

To return to a split screen presentation repeat the steps in [Starting a split screen presentation on page 31](#).

Presenting with mobile devices

Users with mobile devices can connect their mobile devices to the Host and make a presentation via the InstaShare app by following the steps below:

1. Install the InstaShare app on your mobile device using the QR code located on the guide screen.
2. The name of the Host is displayed on your mobile device's Wi-Fi menu, select it to make a Wi-Fi connection. No password is required.

3. Select a desired function and follow the on-screen instructions to project.

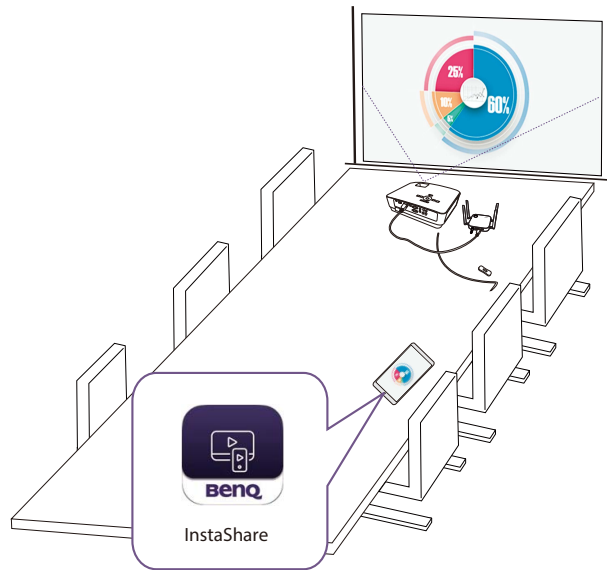

Functions and interface of the app may be updated without prior notice

Touch back

When a Host is connected to a touchscreen display and a PC is presenting via a Button, you can use a USB Type-A cable to connect any of the USB ports located at the rear of the Host to the touch input USB port of the display to control the interface of the PC remotely via touch gestures on the display.

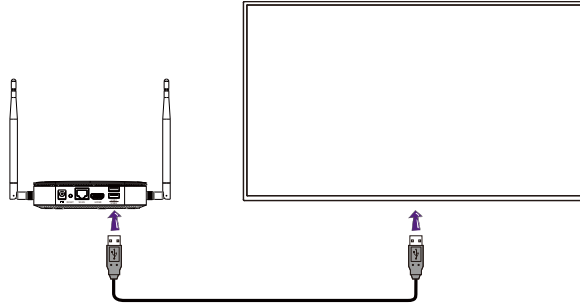

The product only supports touch back for Windows-based PCs. It does not support touch back for MacBooks or smartphones connected via the InstaShare app.

For presentations that do not feature a touchscreen display, you can connect a USB mouse and/or USB keyboard to any of the USB ports located at the rear of the Host to control the interface of the presenting computer and input text remotely via the mouse/keyboard.

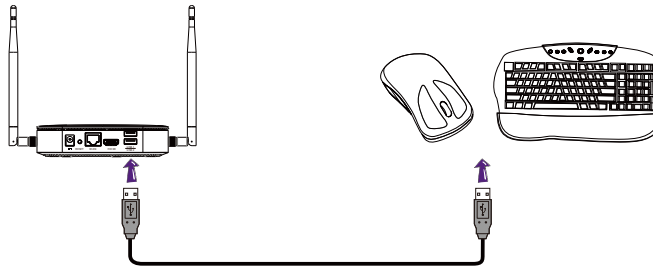

Web management

The product is equipped with a web management interface that enables you to configure its features through a browser such as Google Chrome (version 49.0.26), Internet Explorer (version 8.0), or Firefox (version 46.0.1).



The features may vary according to different firmware versions.

Accessing the web management interface

Logging into the web management interface via direct connection

1. Connect your Host directly to a laptop using a network cable (RJ-45) and to a power source using the power adapter.

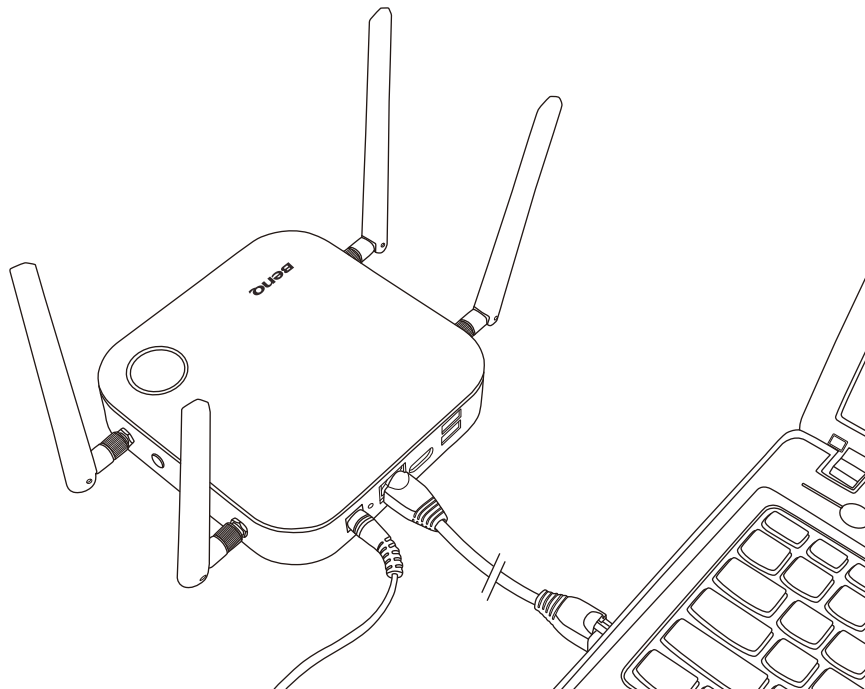

2. Wait until the LED indicator on your Host lights up static green.

- The default IP address of your Host is 192.168.20.1. Change your laptop's IP address to 192.168.20.x (e.g. 192.168.20.100).

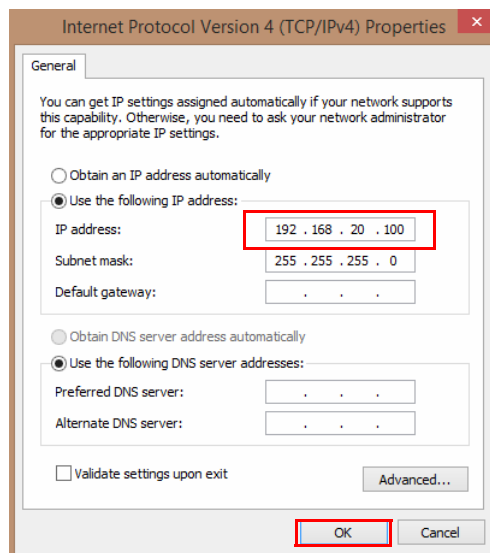
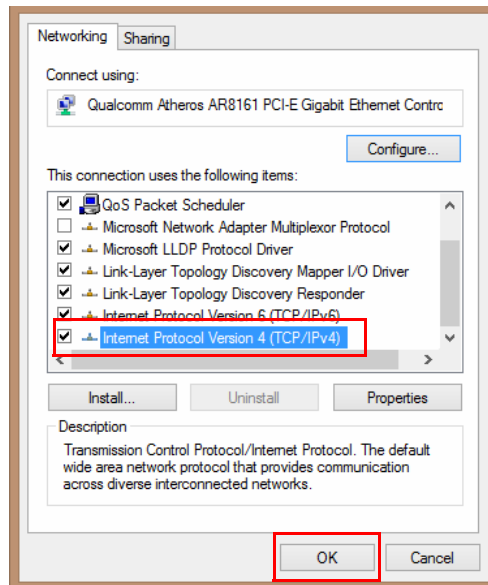

- On your browser, enter the IP address: 192.168.20.1. On the login page, enter the default user name (admin) and password (0000).

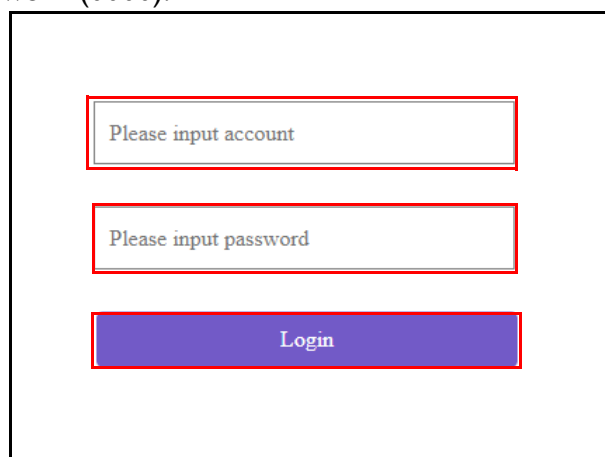

- You will successfully log into the web management interface.

Logging into the web management interface via LAN

If your Host is connected to your LAN, you can enter the IP Address shown on the screen via a web browser.

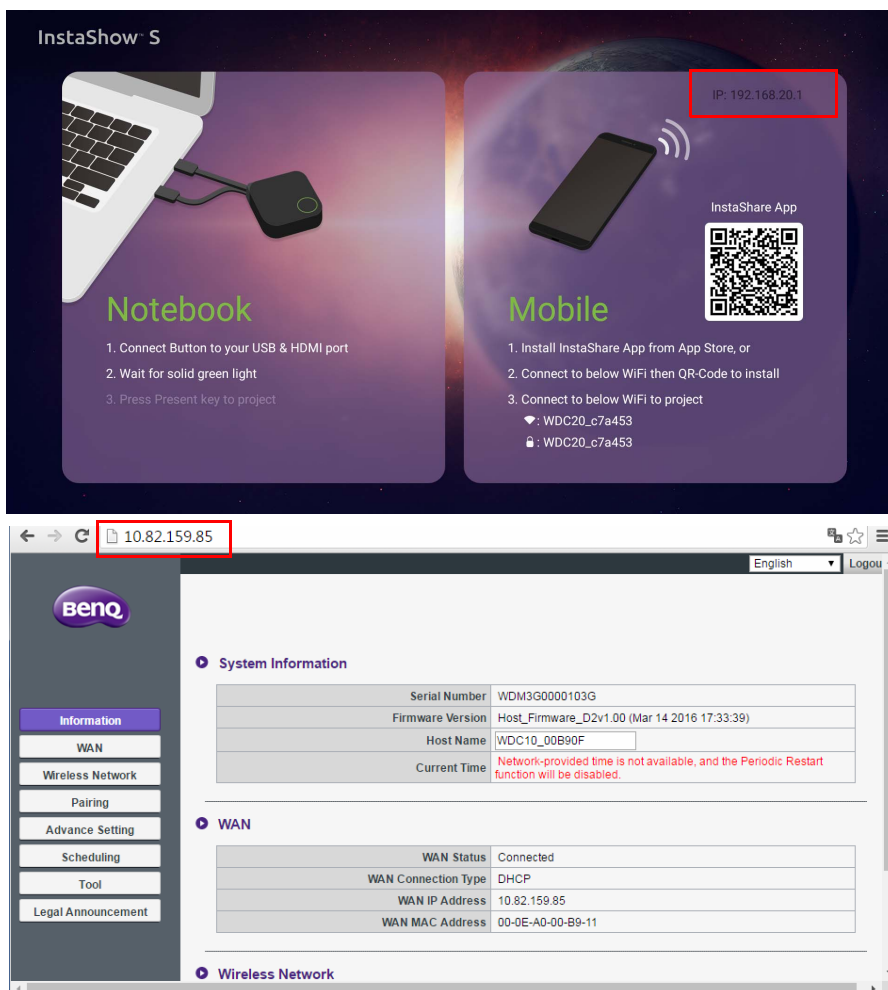

Logging into the web management interface via a wireless network

The product supports 802.11 ac/n. It is compatible with most devices with Wi-Fi capability (e.g. laptop or mobile devices), you can locate the Host via the WDC20_XXXXXX SSID (shown in the Guide/Idle screen) in your laptop or mobile device's wireless network menu and connect to it. The default password is the same as the name of the SSID (for example, if the SSID is "WDC20_c7a3ae", the password will be "WDC20_c7a3ae"). When the device is connected to the Host, enter the IP Address, "192.168.168.2" in a web browser, then enter the user name and password as shown in step 4 of [Logging into the web management interface via direct connection on page 35](#).

The following is an example of how you can log into the web management interface via a mobile device with IEEE 802.11ac.

1. Go to **Settings > Wi-Fi**, and you can find the SSID of your Host: WDC20_c7a3ae.

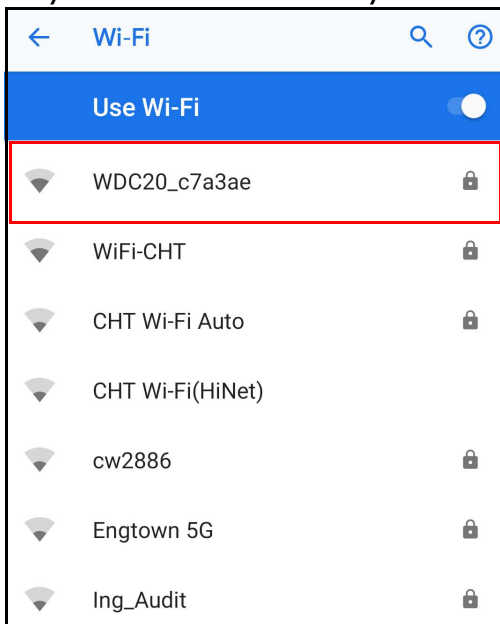

2. Enter the default password "WDC20_c7a3ae" and press **Connect**.

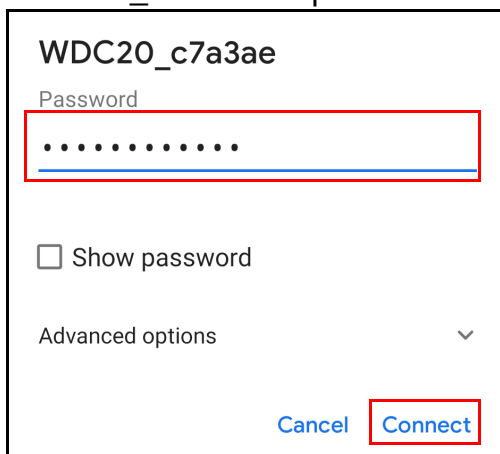

3. Access the web management interface following step 4-5 of [Logging into the web management interface via direct connection on page 35](#).

Getting started

You can now use the web management interface to configure various settings of your Host.

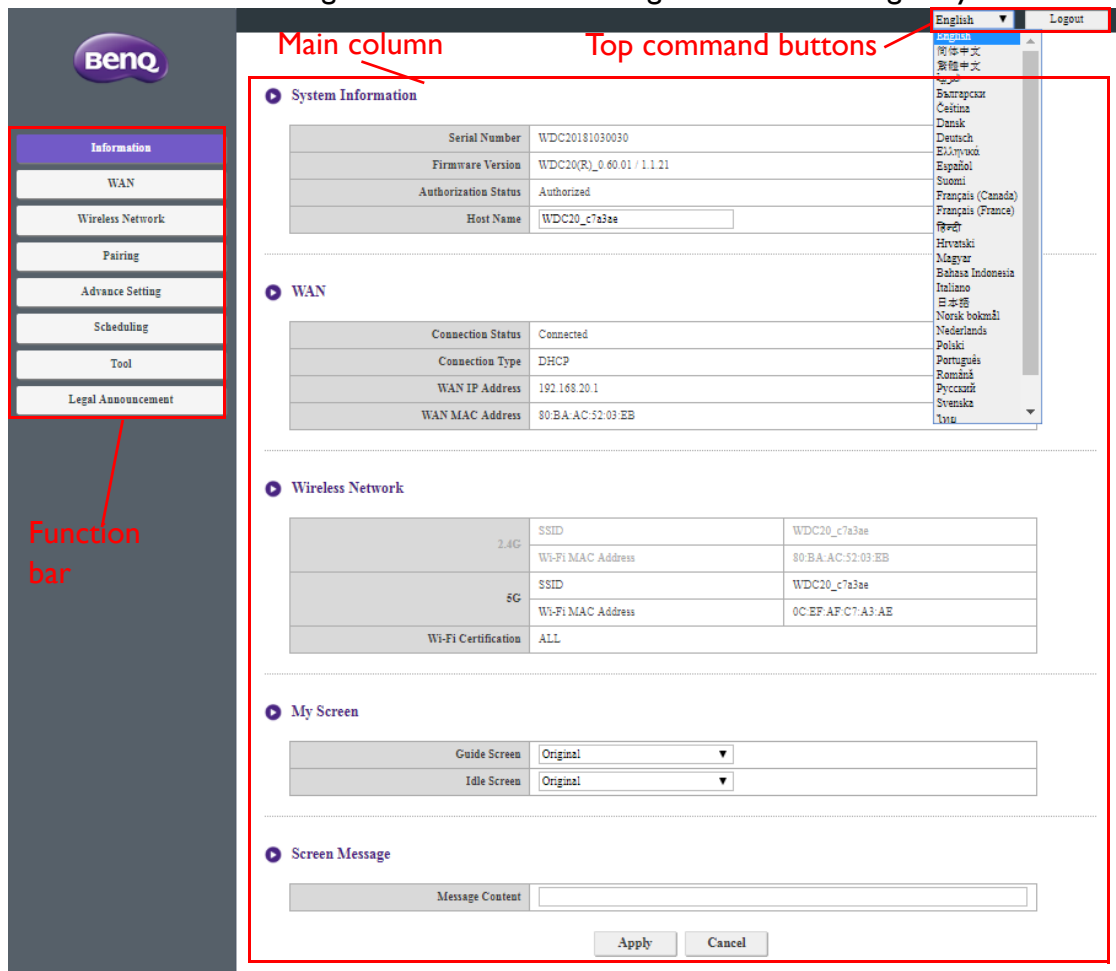

Top command buttons

Change language

1. The default language is English. To change the interface language, go to the language settings panel and you can see all available languages.
2. Click the language you want to switch to and your new language will be set.
3. Once a new language has been set both the web management interface and the product's OSD will feature the new language.



Supported languages vary by country/region where you purchase.

Logging out

Click **Logout** on the upper right corner.

Function bar

The function bar shows the settings menus available in the web management interface.

Main column

The main column shows the detailed content from the function bar.

Information

Click **Information** and you will see detailed information for **System Information**, **WAN**, **Wireless Network**, **My Screen**, and **Screen Message**.

The screenshot shows the BenQ web management interface. On the left is a vertical navigation menu with the BenQ logo at the top. The 'Information' menu item is highlighted with a red border. Below it are other menu items: WAN, Wireless Network, Pairing, Advance Setting, Scheduling, Tool, and Legal Announcement. The main content area is titled 'English' and 'Logout' in the top right corner. It contains five sections, each with a table of settings:

- System Information**:

Serial Number	WDC20181030030
Firmware Version	WDC20(R)_0.60.01 / 1.1.21
Authorization Status	Authorized
Host Name	WDC20_c7a3ae
- WAN**:

Connection Status	Connected
Connection Type	DHCP
WAN IP Address	192.168.20.1
WAN MAC Address	80:BA:AC:52:03:EB
- Wireless Network**:

2.4G	SSID	WDC20_c7a3ae
	Wi-Fi MAC Address	80:BA:AC:52:03:EB
5G	SSID	WDC20_c7a3ae
	Wi-Fi MAC Address	0CEF:AF:C7:A3:AE
Wi-Fi Certification		ALL
- My Screen**:

Guide Screen	Original
Idle Screen	Original
- Screen Message**:

Message Content	<input type="text"/>
-----------------	----------------------

At the bottom of the main content area are 'Apply' and 'Cancel' buttons.

You can change the **Host Name** under **System Information**.

This is a close-up of the 'System Information' section from the screenshot above. The 'Host Name' field, containing the value 'WDC20_c7a3ae', is highlighted with a red border to indicate it is the field that can be changed.

Serial Number	WDC20181030030
Firmware Version	WDC20(R)_0.60.01 / 1.1.21
Authorization Status	Authorized
Host Name	WDC20_c7a3ae

You can change the background image for the Host's guide screen and/or idle screen by selecting **Custom** in the **Guide Screen** or **Idle Screen** fields, then clicking the **Select Image** button that appears, and then navigating to and selecting the image file on your local folder you want as either the Hosts **Guide Screen** or **Idle Screen**.

My Screen

Guide Screen	Custom	Select Image	<input type="checkbox"/> Tutorial Hide
Idle Screen	Custom	Select Image	<input type="checkbox"/> Tutorial Hide



- To hide the tutorial boxes on either the **Guide Screen** or **Idle Screen**, check the **Tutorial Hide** box.
- To revert to the default **Guide Screen** or **Idle Screen**, select **Original** in the respective screen's field.

Guide Screen

Background Image

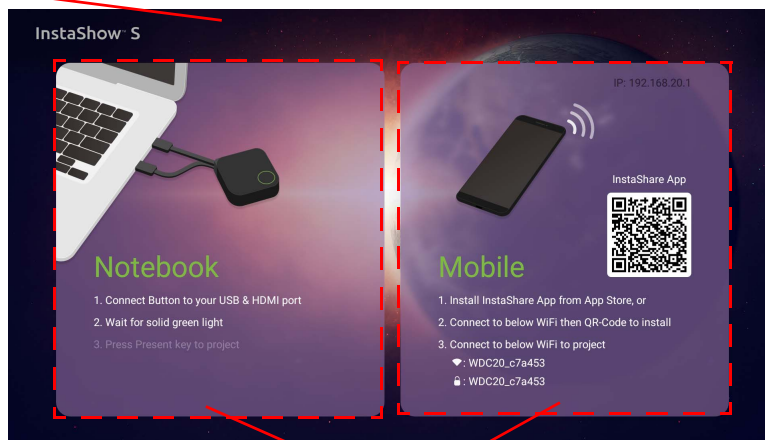

Tutorial Boxes

Idle Screen

Background Image



Tutorial Boxes

You can enter messages under **Screen Message**. After filling in a message, press **Apply** to proceed. Your message will be shown at the top of the Guide/Idle Screen.

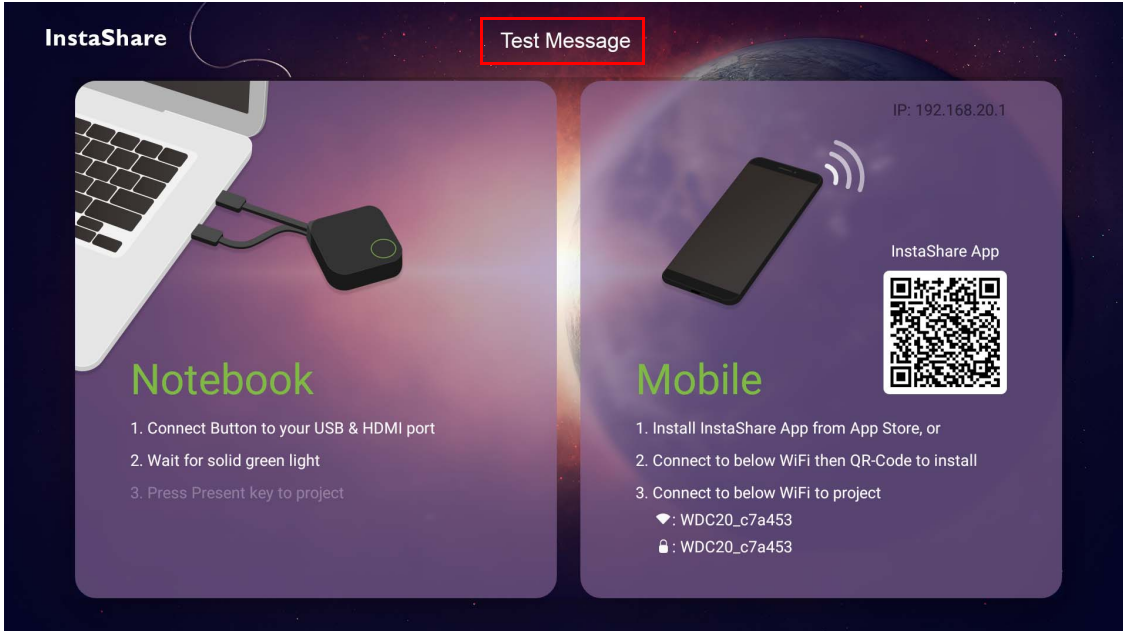

 For **Screen Message**, the maximum lines allowed is 1 line, and the maximum number of characters allowed per line is 100 characters (alphanumeric or Chinese).

WAN

Click **WAN** and you will see the default **WAN IP Address** of the Host. The default connection type is DHCP which acquires the IP Address from your DHCP server of your network. If you want to change your **WAN IP Address**, choose **Static IP** under **WAN Connection Type**. Press **Apply** after changing the **WAN IP Address**.

Connection Type	DHCP	When DHCP, the following settings will be applied.
WAN IP Address	192 . 168 . 20 . 1	<input checked="" type="checkbox"/> Show In Screen
Subnet Mask	255 . 255 . 255 . 0	
Default Gateway		

Wireless Network

Click **Wireless Network** and you will see the **Setting**, **Wi-Fi Radio Setup**, and **Wireless Nodes Status** menu for the Host.

The screenshot displays the BenQ web management interface. On the left is a navigation menu with options: Information, WAN, **Wireless Network** (highlighted), Pairing, Advance Setting, Scheduling, Tool, and Legal Announcement. The main content area is titled 'Setting' and contains three sections:

- Setting**: A table with fields for SSID (WDC20_c8e069), Wi-Fi Security Option (WPA2 Personal Mixed), Password Setting (masked), Isolate (Enable), 2.4G Enable (Disable), and 5G Enable (Enable). A 'Hide' checkbox is next to the SSID field. 'Apply' and 'Cancel' buttons are below.
- Wi-Fi Radio Setup**: A table with fields for Transmission Power (Heavy), Wi-Fi Area (E SKU), 2.4G Channel (Auto), 2.4G Channel Width (20Mhz), 2.4G Mode (N Only), 5G Channel (Auto), 5G Channel Width (40Mhz), and 5G Mode (AC Only). 'Apply' and 'Cancel' buttons are below.
- Wireless Nodes Status**: A table with columns: MAC Address, Device Name, IP Address, 2.4G-5G, and Uptime.

Setting

The Wi-Fi SSID for the Host is displayed in the SSID field. The SSID for the Host is based on the **Host Name** set in the **Information > System Information** menu, to change the SSID for the Host use the **Host Name** field in the **System Information** menu.

If you prefer not to show SSID and password, check **Hide**.

This close-up screenshot focuses on the 'Setting' section. The 'SSID' field contains 'WDC20_c8e069' and the 'Hide' checkbox is checked. The 'Wi-Fi Security Option' is 'WPA2 Personal Mixed', 'Password Setting' is masked, 'Isolate' is 'Enable', '2.4G Enable' is 'Disable', and '5G Enable' is 'Enable'. 'Apply' and 'Cancel' buttons are at the bottom.

Wi-Fi Security Option provides the user **WPA2 Personal** and **WPA2 Personal Mixed** security options for the Host's wireless connection when users access the web management interface via a wireless network.

Setting

SSID	WDC20_c8e069 <input type="checkbox"/> Hide
Wi-Fi Security Option	WPA2 Personal Mixed ▼
Password Setting	WPA2 Personal Mixed <input checked="" type="checkbox"/> Show In Screen
Isolate	Enable ▼
2.4G Enable	Disable ▼
5G Enable	Enable ▼

Apply Cancel

WPA2 Personal allows only users with Advanced Encryption Standard (AES) encryption to connect to the Host.

WPA2 Personal Mixed allows users with various encryption methods to connect to the Host, which may be needed for users with older wireless devices.



The Wi-Fi security options described above only applies to the Wi-Fi connection used to access the web management interface via a wireless network. The Wi-Fi connection used for data transfer between the Host and Buttons utilizes a fixed WPA2-PSK security setting which cannot be changed.

Isolate is a security setting that allows you to isolate all Wi-Fi connections to the Host, so that devices that are connected to the Host via a Wi-Fi connection are isolated and cannot access any of the other devices connected to the Host for possible hacking. The default setting for this field is **Enable**. To deactivate the isolation setting and allow Wi-Fi devices connected to the Host to access each other select **Disable**.

Setting

SSID	WDC20_c8e069 <input type="checkbox"/> Hide
Wi-Fi Security Option	WPA2 Personal Mixed ▼
Password Setting	***** <input checked="" type="checkbox"/> Show In Screen
Isolate	Enable ▼
2.4G Enable	Disable ▼
5G Enable	Enable ▼

Apply Cancel

You can choose the available frequencies for the Host's Wi-Fi signal in the **2.4G Enable** and **5G Enable** fields. A 2.4G Wi-Fi signal is a signal that features a larger coverage range but slower data speeds and is more commonly used by older mobile devices, while a 5G Wi-Fi signal features faster data speeds at a smaller range. To enable or disable either 2.4G or 5G Wi-Fi signals by selecting **Enable** or **Disable** in the **2.4G Enable** and/or **5G Enable** fields.

SSID	WDC20_c8e069 <input type="checkbox"/> Hide
Wi-Fi Security Option	WPA2 Personal Mixed ▼
Password Setting	***** <input checked="" type="checkbox"/> Show In Screen
Isolate	Enable ▼
2.4G Enable	Disable ▼
5G Enable	Enable ▼



- Certain mobile devices are unable to access 5G Wi-Fi signals due to hardware limitations. If your mobile device is unable to connect to the Host via Wi-Fi, select **Enable** in the **2.4G Enable** field.
- Both **2.4G Enable** and **5G Enable** can be enabled at the same time.

After you configure all the **Wireless Network > Setting** items, press **Apply** to proceed.

SSID	WDC20_c8e069 <input type="checkbox"/> Hide
Wi-Fi Security Option	WPA2 Personal Mixed ▼
Password Setting	***** <input checked="" type="checkbox"/> Show In Screen
Isolate	Enable ▼
2.4G Enable	Disable ▼
5G Enable	Enable ▼

Wi-Fi Radio Setup

In the **Transmission Power** field you can set the strength of the Wi-Fi signal with the available options being of **Heavy** for a strong Wi-Fi signal (20 dbm for 2.4G; 15 dbm for 5G), **Standard** for a standard Wi-Fi signal (18 dbm for 2.4G; 12 dbm for 5G), and **ECO** (15 dbm for 2.4G; 10 dbm for 5G) for a weaker, energy saving signal.

Transmission Power	Heavy ▼
Wi-Fi Area	Standard
2.4G Channel	ECO
2.4G Channel Width	20Mhz ▼
2.4G Mode	N Only
5G Channel	Auto ▼
5G Channel Width	40Mhz ▼
5G Mode	AC Only ▼

In the **2.4G Channel** and **5G Channel** fields you can configure the Host to automatically select the wireless channel with the best performance for either signal during the initial setup of the Host by selecting **Auto**, or you can select a wireless channel manually. The default **2.4G Channel** and **5G Channel** setting for the Host is **Auto**.

Wi-Fi Radio Setup

Transmission Power	Heavy
Wi-Fi Area	ALL
2.4G Channel	Auto
2.4G Channel Width	1
2.4G Mode	2
5G Channel	3
5G Channel Width	4
5G Mode	5

el

Wi-Fi Radio Setup

Transmission Power	Heavy
Wi-Fi Area	ALL
2.4G Channel	Auto
2.4G Channel Width	20Mhz
2.4G Mode	N Only
5G Channel	Auto
5G Channel Width	36
5G Mode	40

el

In the **2.4G Channel Width** and **5G Channel Width** fields you can configure the channel width for your 2.4G and/or 5G Wi-Fi signal. The available options for **2.4G Channel Width** are **20MHz** and **40MHz**, while the available options for **5G Channel Width** are **20MHz**, **40MHz**, and **80MHz**. The default channel width for **2.4G Channel** is **20MHz** while the default channel width for **5G Channel** is **40MHz**.

Wi-Fi Radio Setup

Transmission Power	Heavy
Wi-Fi Area	ALL
2.4G Channel	Auto
2.4G Channel Width	20MHz
2.4G Mode	20MHz 40MHz
5G Channel	Auto
5G Channel Width	40MHz
5G Mode	AC Only

Apply Cancel

Wi-Fi Radio Setup

Transmission Power	Heavy
Wi-Fi Area	ALL
2.4G Channel	Auto
2.4G Channel Width	20MHz
2.4G Mode	N Only
5G Channel	Auto
5G Channel Width	40MHz 20MHz 40MHz 80MHz
5G Mode	

Apply Cancel



The supported wireless channels listed vary according to wireless regulations of the country/region which is listed in the **Wi-Fi Area** field.

In **5G Mode**, you can select the Wi-Fi standard for the 5G Wi-Fi signal. The available options are **N Only** and **AC Only**. The default **5G Mode** setting is **N Only**.

Wi-Fi Radio Setup

Transmission Power	Heavy
Wi-Fi Area	ALL
2.4G Channel	Auto
2.4G Channel Width	20MHz
2.4G Mode	N Only
5G Channel	Auto
5G Channel Width	40MHz
5G Mode	AC Only N Only AC Only

Apply Cancel



The Wi-Fi standard for the 2.4G Wi-Fi signal in the **2.4G Mode** field is set to **N Only** and cannot be configured.

After you configure all the **Wireless Network** settings, press **Apply** to proceed.

Wi-Fi Radio Setup

Transmission Power	Heavy
Wi-Fi Area	ALL
2.4G Channel	Auto
2.4G Channel Width	20Mhz
2.4G Mode	N Only
5G Channel	Auto
5G Channel Width	40Mhz
5G Mode	AC Only

Apply **Cancel**

Wireless Nodes Status

The **Wireless Nodes Status** sub-menu lists all the devices connected to the Host via Wi-Fi indicates their **MAC Address**, **Device Name**, **IP Address**, Wi-Fi channel used (**2.4G/5G**), and connection time (**Uptime**).

Wireless Nodes Status

MAC Address	Device Name	IP Address	2.4G/5G	Uptime
B0:F1:EC:7A:BC:50	1525999155	192.168.168.136	5G	7m 36s

Pairing

Click **Pairing** and you will see **Pairing** and **Pairing Status**.

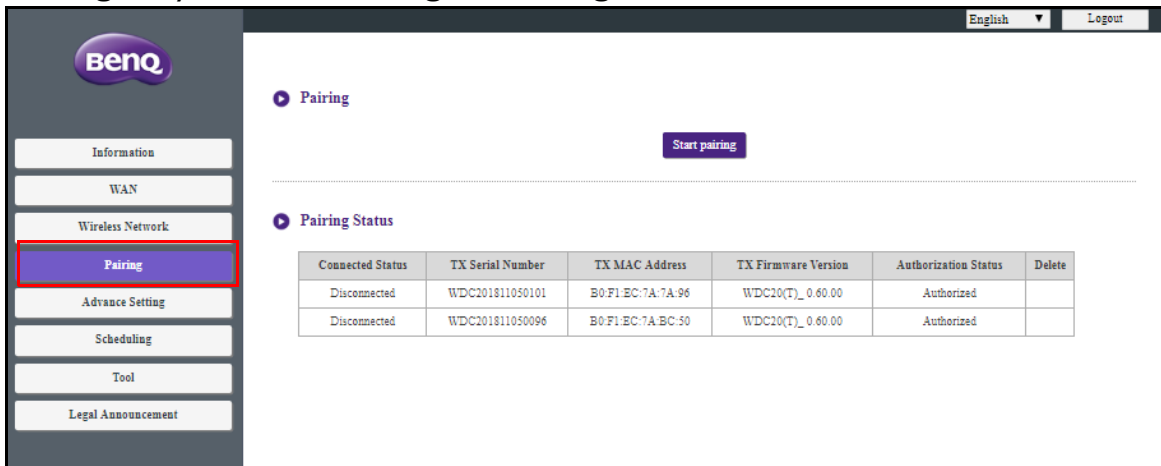

Pairing is used when the Host is attached to the ceiling as it is not easy to press the **PAIRING** key of the Host when the device is high on the ceiling. You can pair a Button and Host via the web management interface.

1. Connect the Button's HDMI and USB jacks to the corresponding ports of a laptop.

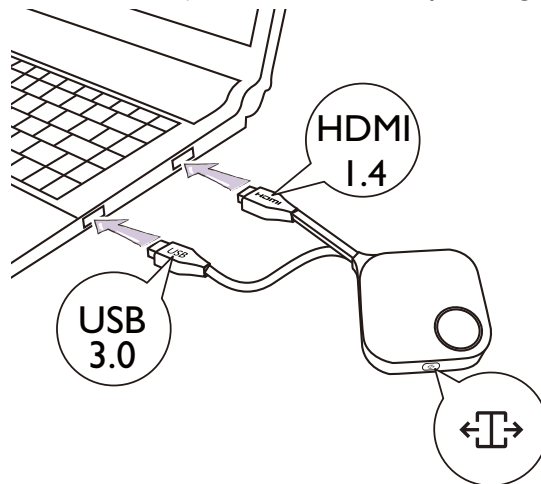

2. When the Button is successfully connected to the laptop, the LED indicator of the Button will blink green.



3. Make sure the Host is properly connected to a power source.
4. Enable the 2.4G Wi-Fi channel in the **Wi-Fi Radio Setup** menu.

5. Press **Start pairing** to pair the Host to the Button via the web management interface, you will have two minutes to pair with the Button.



6. Press the split screen key on the side of the Button for five seconds. The LED indicator of the Button will blink blue for about 10 seconds. The pairing process is ongoing. A “Pairing in progress” message will be shown on the screen.

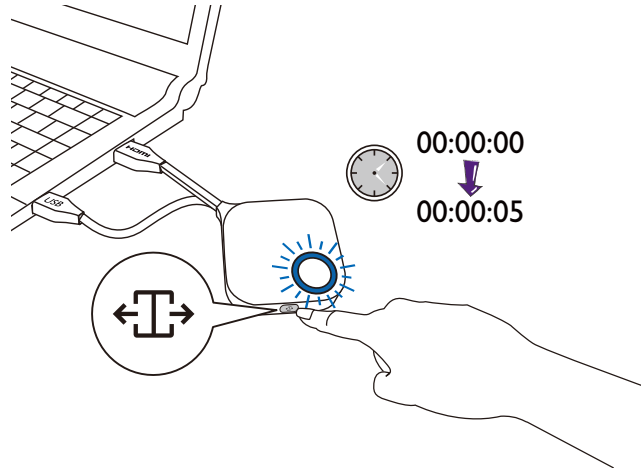

7. The LED indicator of the Button will turn static green when the Host and Button are successfully paired.

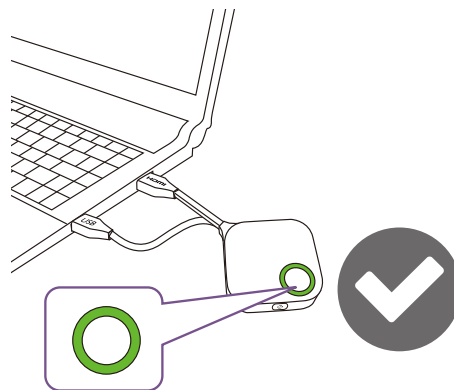

- Images are for reference only. Each product features a different serial number.
- The maximum number of Buttons you can pair with one Host is 32.

8. You may press **Stop pairing** anytime to stop the pairing process.

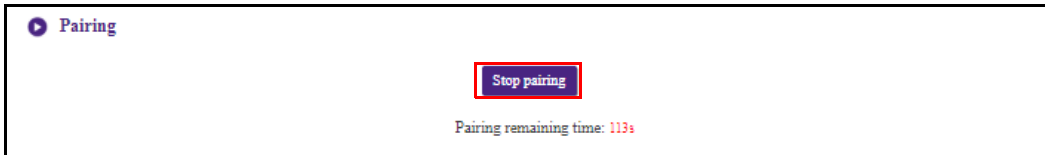

Advance Setting

Click **Advance Setting** to adjust **Firewall**, **Host Output Resolution**, **Screen Scale**, **4 Way Split**, **Stream Encryption**, **Login Code**, **HDCP Auto**, **Allow AirPlay and Chromecast**, and **Network Standby**.

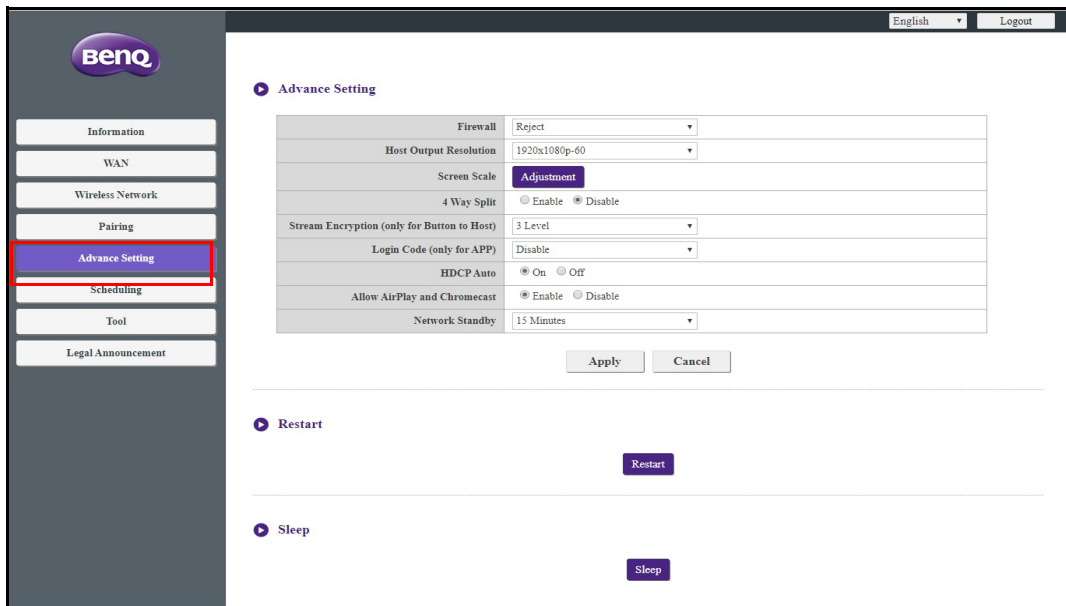

Firewall is a security setting that allows you to block/reject users from accessing the Host via its WAN port in order to protect it from hacking. The default setting for this field is **Reject** which enables the firewall and rejects access to the Host via its WAN port. To disable the firewall and allow devices to access the Host via its WAN port select **Accept**. A warning message is prompted to let you know the security risk.

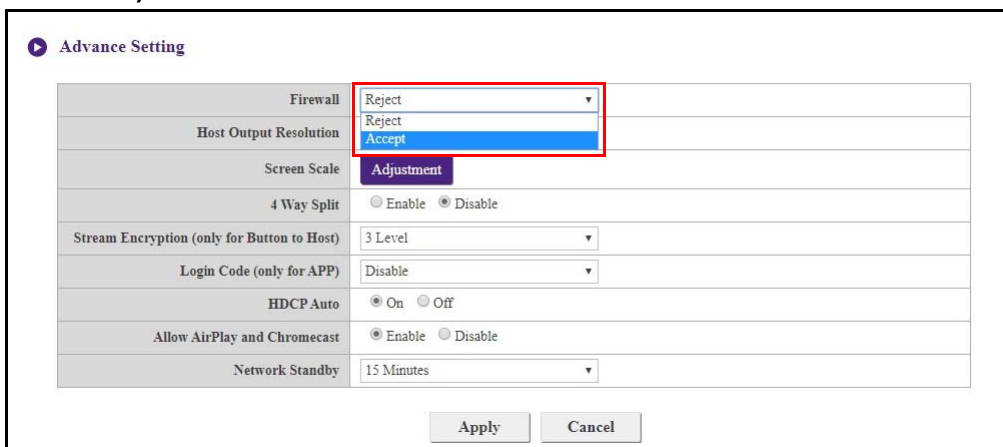

Users will still be able to access the web management interface via a direct connection to the WAN port when the **Firewall** is set to **Reject**.

Host Output Resolution configures the Host's output resolution for video broadcast by the Host. When **Host Output Resolution** mode is set to **Auto** the Host will select the output resolution based on the connected display's native timing, or you can select an output resolution manually.

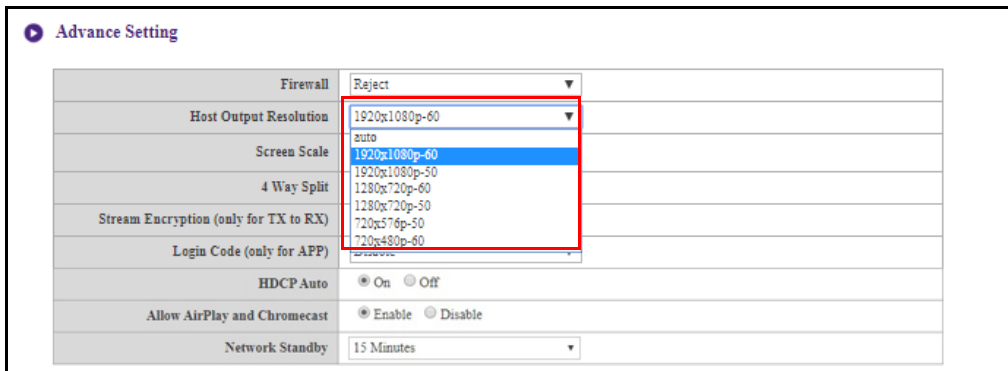

Screen Scale allows users to adjust the borders of the Host's video output so that it properly fits the screen of the connected display. This setting is mainly intended for users who connect the Host to a touchscreen display, so that the edges of the video align to the edges of the display's screen to ensure the accuracy of touch gestures. To adjust the **Screen Scale** setting, click the **Adjustment** button, then use the toggle buttons to scale the video to fit the screen.

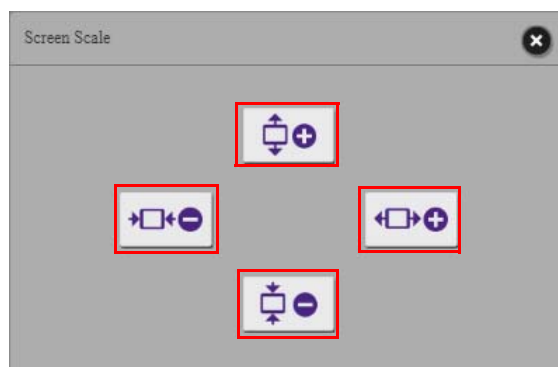
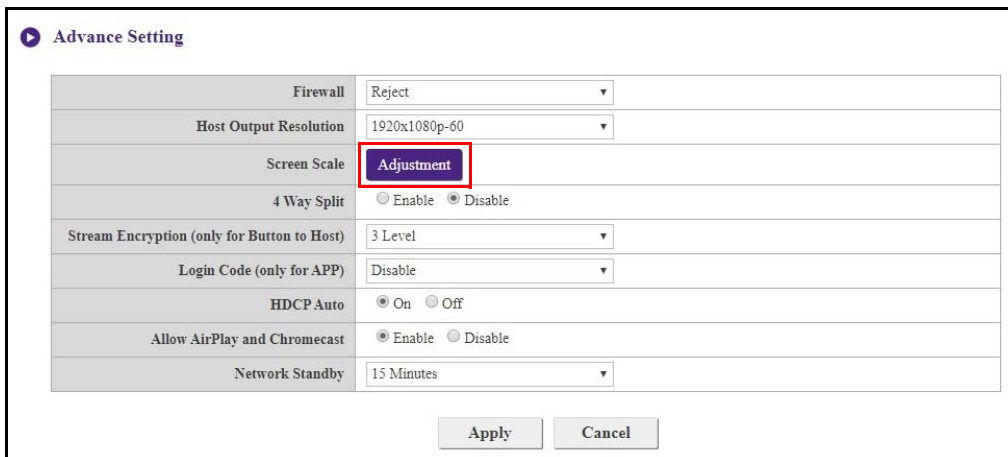

4 Way Split enables or disables split screen presentations and has the same function as the split screen button on a Button. See [Split screen presentations on page 31](#) for more information split screen presentations.

The screenshot shows the 'Advance Setting' menu with the following settings:

Firewall	Reject
Host Output Resolution	1920x1080p-60
Screen Scale	Adjustment
4 Way Split	<input type="radio"/> Enable <input checked="" type="radio"/> Disable
Stream Encryption (only for Button to Host)	3 Level
Login Code (only for APP)	Disable
HDCP Auto	<input checked="" type="radio"/> On <input type="radio"/> Off
Allow AirPlay and Chromecast	<input checked="" type="radio"/> Enable <input type="radio"/> Disable
Network Standby	15 Minutes

Buttons: Apply, Cancel

Stream Encryption is a security setting that allows you to select the level of encryption for the connection between the Host and Buttons in order to protect it from hacking. The default setting for this field is **3 Level**, to change the setting to a lower level of encryption select **2 Level**.

The screenshot shows the 'Advance Setting' menu with the 'Stream Encryption (only for TX to RX)' dropdown menu open. The options are:

- 3 Level
- 2 Level (highlighted)

Other settings in the menu are the same as in the previous screenshot.

Login Code allows you to set a login password for connections by mobile devices which will appear on the guide screen. The default setting for this field is **Disable** which means that no login password is needed for mobile devices to connect to the Host. To set a custom login password for mobile devices, select **Custom** and then enter the password you want in the field to the right of the **Login Code** field. To set an automatically generated login password select **Random**.

The screenshot shows the 'Advance Setting' menu with the 'Login Code (only for APP)' dropdown menu open. The options are:

- Disable (highlighted)
- Custom
- Random

Other settings in the menu are the same as in the previous screenshots.

Advance Setting

Firewall	Reject
Host Output Resolution	1920x1080p-60
Screen Scale	Adjustment
4 Way Split	<input type="radio"/> Enable <input checked="" type="radio"/> Disable
Stream Encryption (only for TX to RX)	3 Level
Login Code (only for APP)	Custom
HDCP Auto	<input checked="" type="radio"/> On <input type="radio"/> Off
Allow AirPlay and Chromecast	<input checked="" type="radio"/> Enable <input type="radio"/> Disable
Network Standby	15 Minutes

HDCP Auto is a security setting that allows you configure whether or not HDCP digital copy protection is automatically enabled for the content output by the Host. The default setting for this field is **On**, which means that HDCP copy protection will be automatically enabled by Host for content that features HDCP copy protection and disabled for content that does not feature HDCP copy protection. To change the setting so that HDCP copy protection is always enabled by Host select **Off**.

Advance Setting

Firewall	Reject
Host Output Resolution	1920x1080p-60
Screen Scale	Adjustment
4 Way Split	<input type="radio"/> Enable <input checked="" type="radio"/> Disable
Stream Encryption (only for Button to Host)	3 Level
Login Code (only for APP)	Disable
HDCP Auto	<input checked="" type="radio"/> On <input type="radio"/> Off
Allow AirPlay and Chromecast	<input checked="" type="radio"/> Enable <input type="radio"/> Disable
Network Standby	15 Minutes

Allow AirPlay and Chromecast determines whether you allow other devices to join the presentation.

Advance Setting

Firewall	Reject
Host Output Resolution	1920x1080p-60
Screen Scale	Adjustment
4 Way Split	<input type="radio"/> Enable <input checked="" type="radio"/> Disable
Stream Encryption (only for Button to Host)	3 Level
Login Code (only for APP)	Disable
HDCP Auto	<input checked="" type="radio"/> On <input type="radio"/> Off
Allow AirPlay and Chromecast	<input checked="" type="radio"/> Enable <input type="radio"/> Disable
Network Standby	15 Minutes

Network Standby allows you to set the time of inactivity before the Host enters network standby mode.

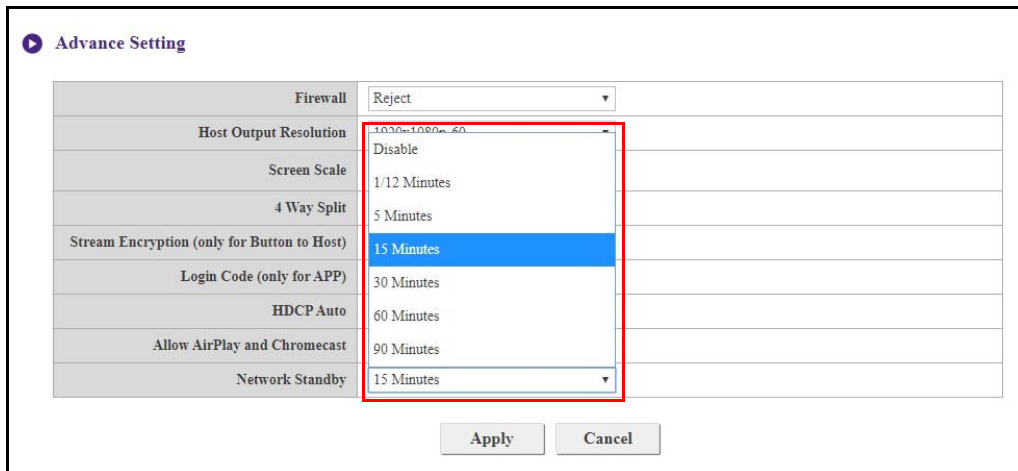

The screenshot shows the 'Advance Setting' menu. The 'Network Standby' dropdown is open, showing options: 15 Minutes (highlighted), 30 Minutes, 60 Minutes, 90 Minutes, and 15 Minutes. The 'Apply' and 'Cancel' buttons are visible at the bottom.

Setting	Value
Firewall	Reject
Host Output Resolution	1920x1080p-60
Screen Scale	Adjustment
4 Way Split	<input type="radio"/> Enable <input checked="" type="radio"/> Disable
Stream Encryption (only for Button to Host)	3 Level
Login Code (only for APP)	Disable
HDCP Auto	<input checked="" type="radio"/> On <input type="radio"/> Off
Allow AirPlay and Chromecast	<input checked="" type="radio"/> Enable <input type="radio"/> Disable
Network Standby	15 Minutes

After you configure all the **Advance Setting** items, press **Apply** to proceed.

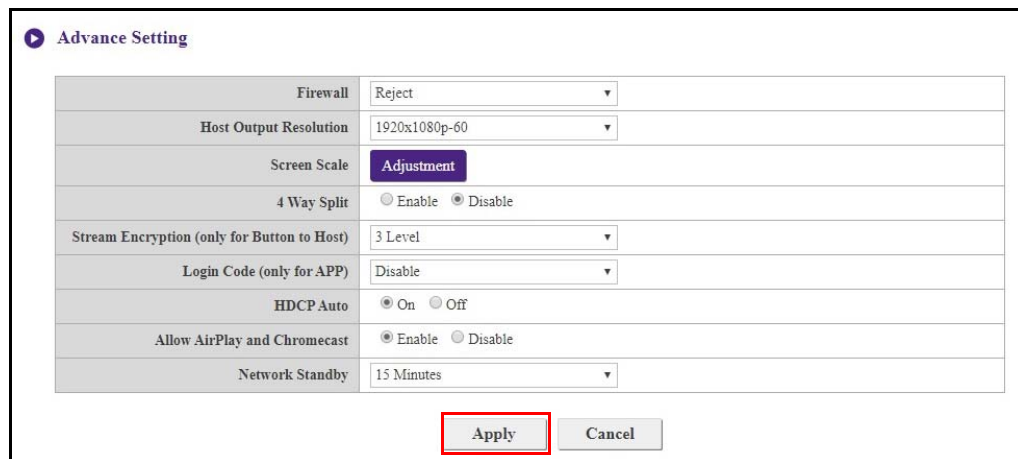

The screenshot shows the 'Advance Setting' menu with the 'Apply' button highlighted. The 'Network Standby' dropdown is now closed and shows '15 Minutes'.

Setting	Value
Firewall	Reject
Host Output Resolution	1920x1080p-60
Screen Scale	Adjustment
4 Way Split	<input type="radio"/> Enable <input checked="" type="radio"/> Disable
Stream Encryption (only for Button to Host)	3 Level
Login Code (only for APP)	Disable
HDCP Auto	<input checked="" type="radio"/> On <input type="radio"/> Off
Allow AirPlay and Chromecast	<input checked="" type="radio"/> Enable <input type="radio"/> Disable
Network Standby	15 Minutes

If you want to restart the Host, click **Restart** and the Host will restart.



The screenshot shows the 'Restart' button highlighted.

If you want to place the Host in sleep mode, click **Sleep**.

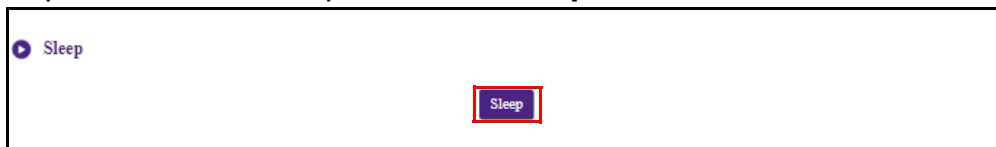

The screenshot shows the 'Sleep' button highlighted.



To wake the Host from sleep mode, press the standby button on the top of the Host.

Scheduling

You can change the schedule by clicking **Scheduling**. You can set **System Time** and **Periodical Restart**.

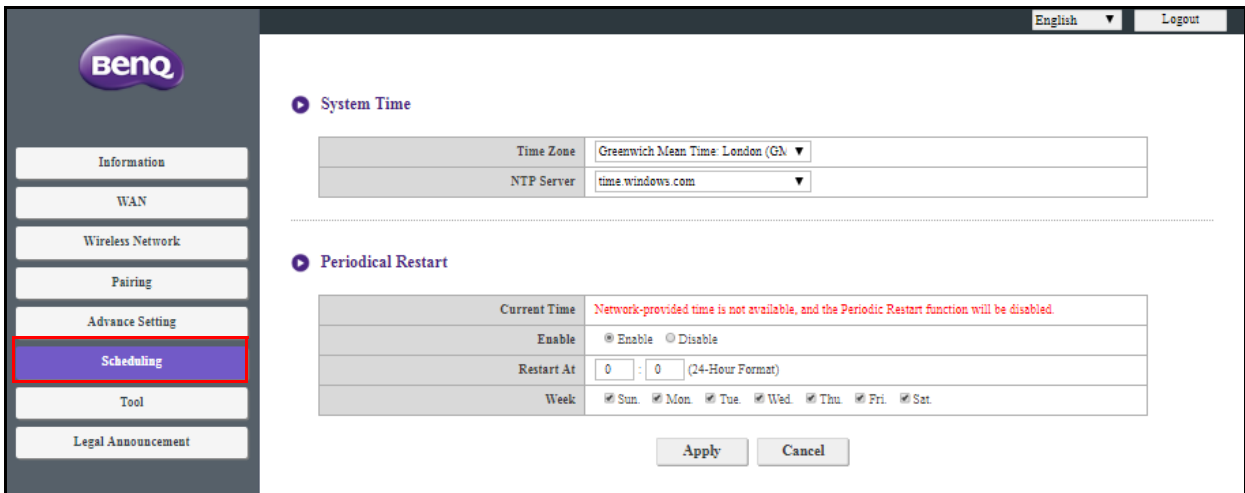

You can select your **Time Zone** and the **NTP Server** from which the time is obtained.



You can check **Enable** to set **Periodical Restart**. You can also set restart time and day.

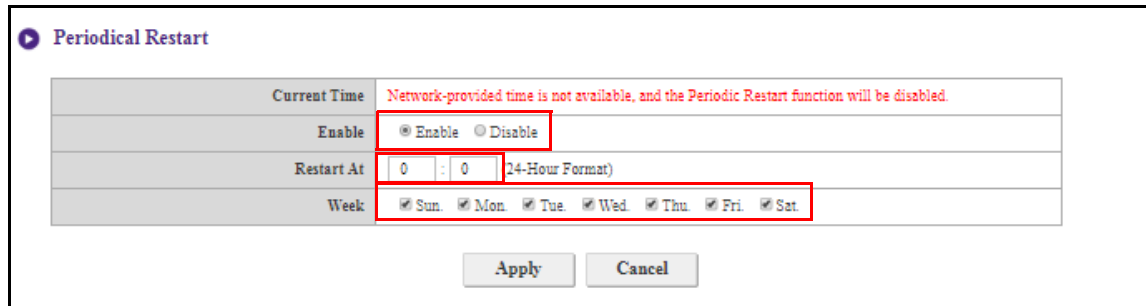

After you configure all the **Scheduling** settings, press **Apply** to proceed.

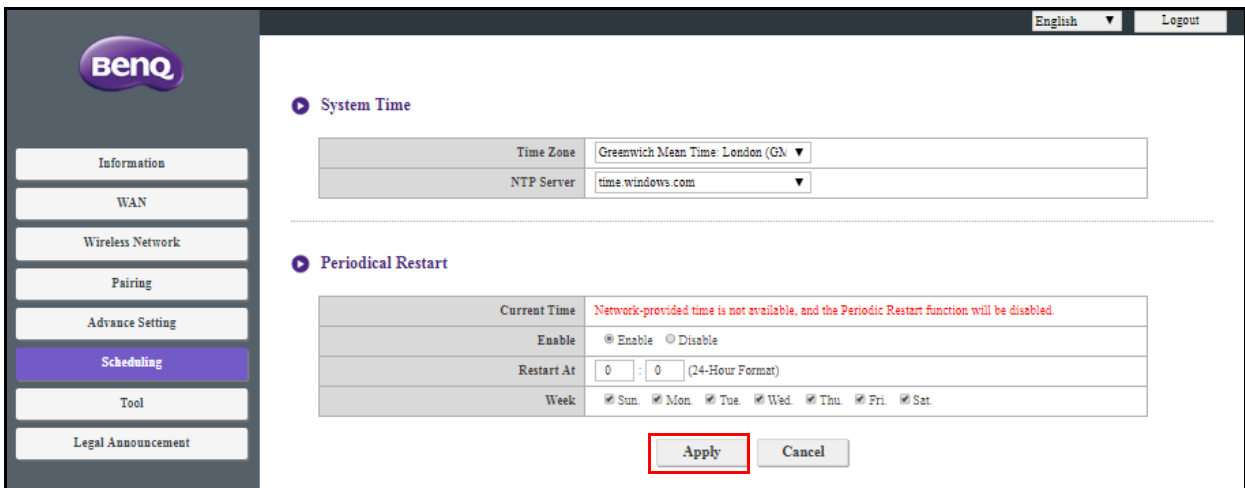

Tool

By clicking **Tool**, you can adjust **Password Setup**, **Firmware Upgrade**, **Configuration Management**, **Wi-Fi Traffic Test**, and **Log Setting**.

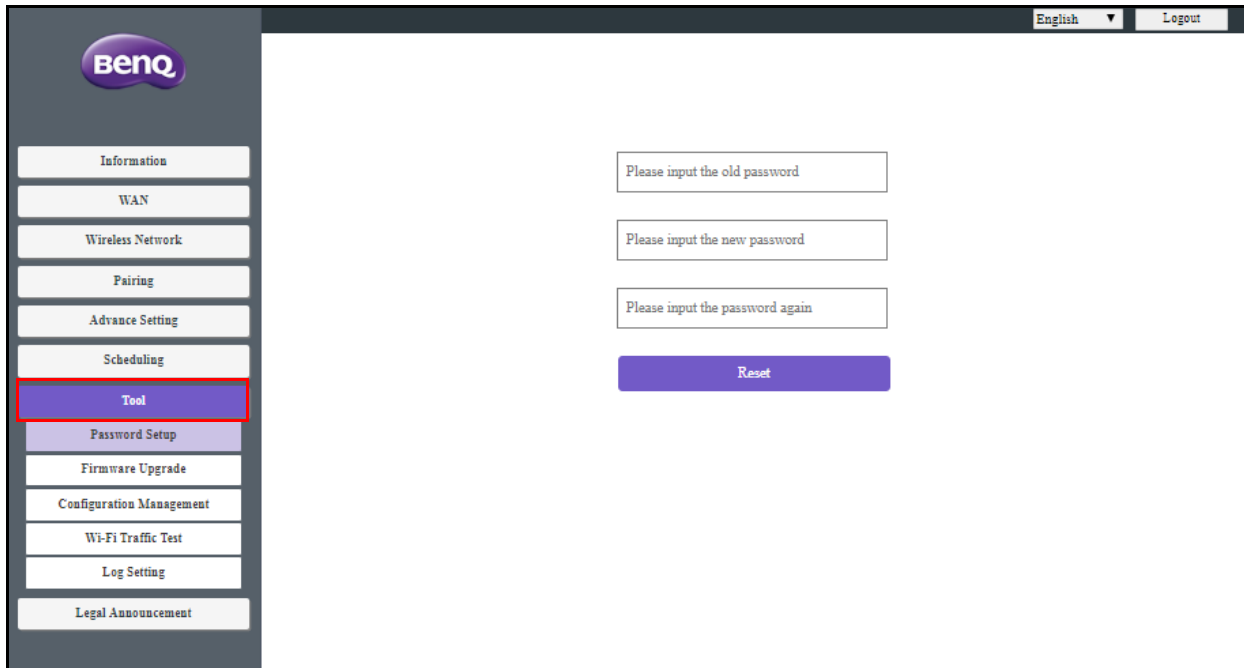

Password Setup

You can change **Password** by:

1. Entering your old password.
2. Entering your new password.
3. Entering your new password again to confirm your new password.
4. Pressing **Reset** to proceed.

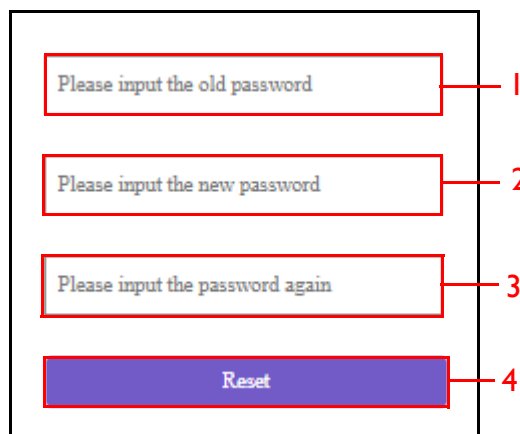

Firmware Upgrade

The **Firmware Upgrade** sub-menu allows you to check for and execute firmware upgrades for both the Host and Button.

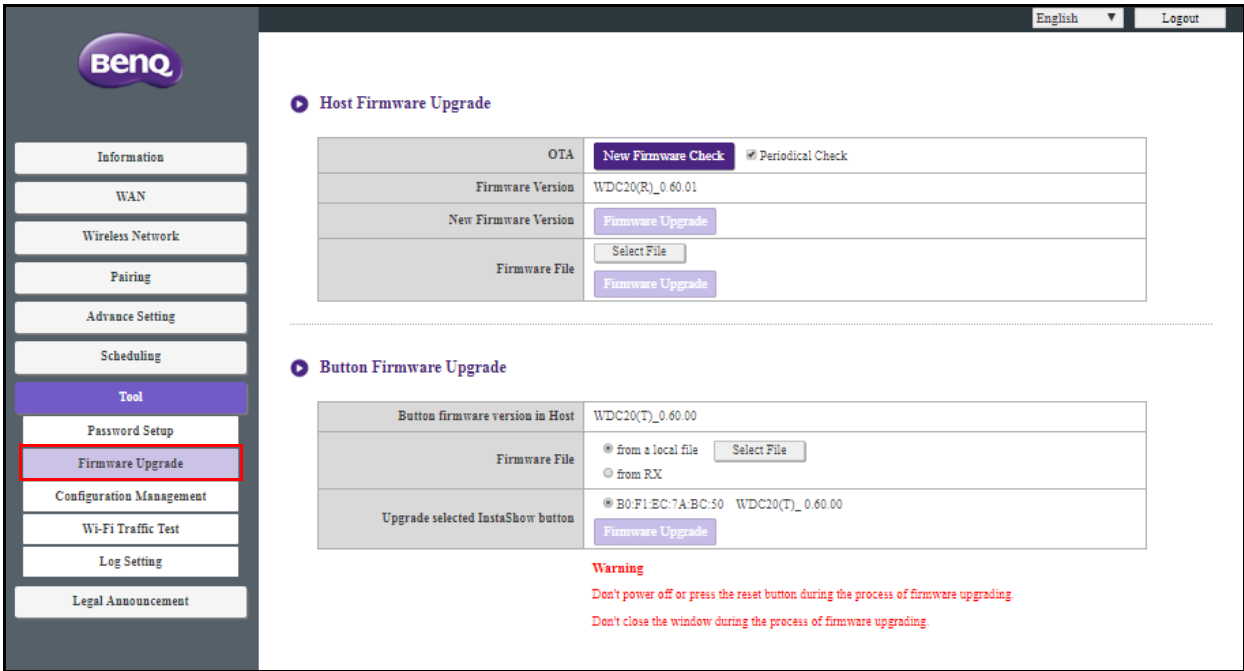

• Checking for Upgrades (for Host)

Before checking for a new firmware upgrade for your Host, ensure that the Host is connected via the WAN port to a router with access to the Internet, then click the **New Firmware Check** button to check for a firmware upgrade. To have the Host periodically check for firmware upgrades check the **Periodical Check** box.

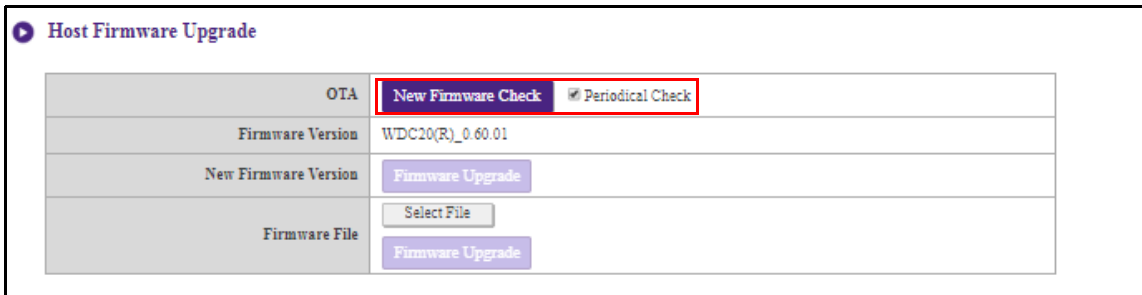

Periodic checks for upgrades can only occur when the Host is connected via the WAN port to a router with access to the Internet.

If a new firmware upgrade is available the new firmware version will be listed in the **New Firmware Version** field.

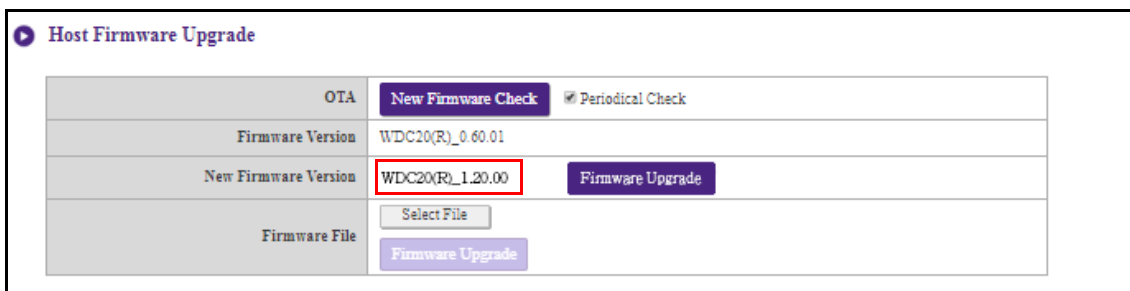

• Upgrading the Host's Firmware

After checking for and confirming the availability of a new firmware upgrade you will be able to upgrade your Host's Firmware. The product allows you to upgrade the Host's firmware using either an OTA (Over The Air) upgrade or a direct upgrade from an upgrade file located on your local computer.

To perform an OTA upgrade of the Host's firmware, click the **Firmware Upgrade** button in the **New Firmware Version** field.

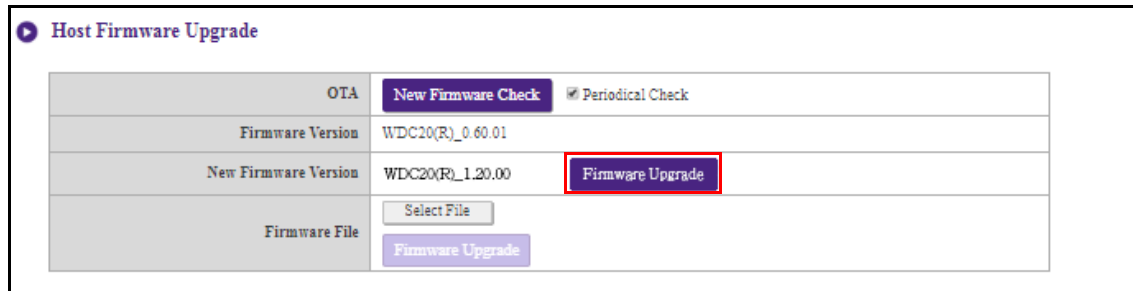

Host Firmware Upgrade	
OTA	<input type="button" value="New Firmware Check"/> <input checked="" type="checkbox"/> Periodical Check
Firmware Version	WDC20(R)_0.60.01
New Firmware Version	WDC20(R)_1.20.00 <input type="button" value="Firmware Upgrade"/>
Firmware File	<input type="button" value="Select File"/> <input type="button" value="Firmware Upgrade"/>

 To perform an OTA ensure that the Host is connected via the WAN port to a router with access to the Internet.

 When performing any type of upgrade DO NOT do any of the following:

- Power off or press the reset button on the Host or Button.
- Close the browser window of the web management interface.

Failure to follow these warnings will result in firmware upgrade failure and subsequent product failure.

To perform a direct upgrade from an upgrade file located on your local computer follow the steps below:

 Before executing a direct firmware upgrade, please contact your BenQ regional office for access to the upgrade files.

1. Click the **Select File** button in the **Firmware File** field.

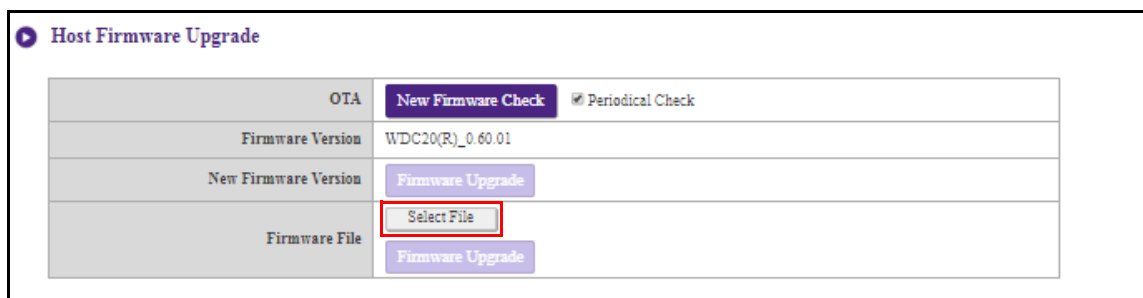

Host Firmware Upgrade	
OTA	<input type="button" value="New Firmware Check"/> <input checked="" type="checkbox"/> Periodical Check
Firmware Version	WDC20(R)_0.60.01
New Firmware Version	<input type="button" value="Firmware Upgrade"/>
Firmware File	<input type="button" value="Select File"/> <input type="button" value="Firmware Upgrade"/>

2. Navigate to and select the firmware upgrade file.

3. Click the **Firmware Upgrade** button in the **Firmware File** field.

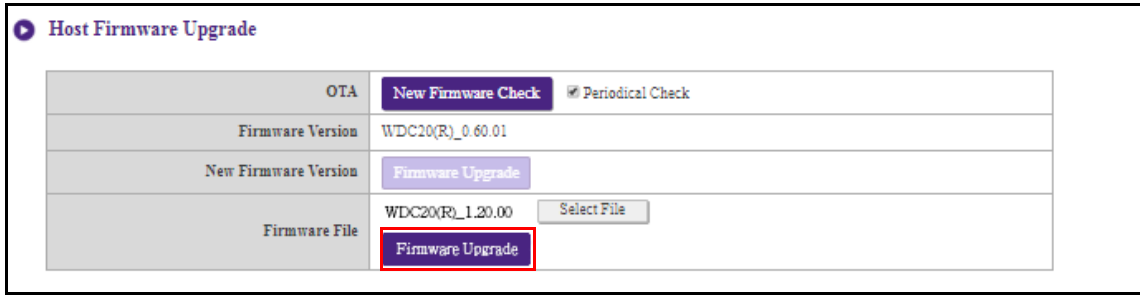

The screenshot shows the 'Host Firmware Upgrade' interface. It features a table with the following rows:

OTA	<input type="button" value="New Firmware Check"/> <input checked="" type="checkbox"/> Periodical Check
Firmware Version	WDC20(R)_0.60.01
New Firmware Version	<input type="button" value="Firmware Upgrade"/>
Firmware File	WDC20(R)_1.20.00 <input type="button" value="Select File"/> <input type="button" value="Firmware Upgrade"/>



When performing any type of upgrade DO NOT do any of the following:

- Power off or press the reset button on the Host or Button.
- Close the browser window of the web management interface.

Failure to follow these warnings will result in firmware upgrade failure and subsequent product failure.

• Upgrading the Button's Firmware

You can upgrade the Button's firmware using an upgrade file located on your local computer or directly from your Host via the connection between the Button and Host.

To upgrade the Button's firmware using an upgrade file located on your local computer follow the steps below:

1. Select **from a local file** in the **Firmware File** field and then click the **Select File** button.

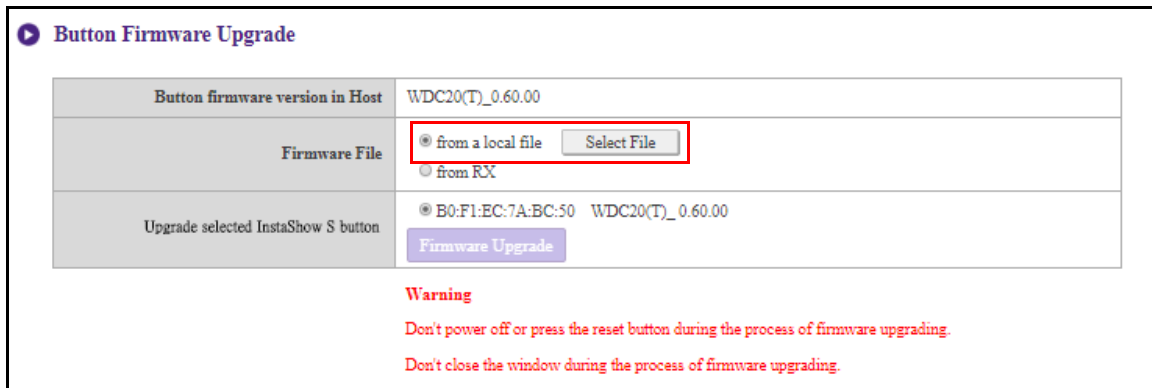

The screenshot shows the 'Button Firmware Upgrade' interface. It features a table with the following rows:

Button firmware version in Host	WDC20(T)_0.60.00
Firmware File	<input checked="" type="radio"/> from a local file <input type="button" value="Select File"/> <input type="radio"/> from RX
Upgrade selected InstaShow S button	<input checked="" type="radio"/> B0:F1:EC:7A:BC:50 WDC20(T)_0.60.00 <input type="button" value="Firmware Upgrade"/>

Warning
Don't power off or press the reset button during the process of firmware upgrading.
Don't close the window during the process of firmware upgrading.

2. Navigate to and select the firmware upgrade file.

3. Select the Button you want to upgrade and then click the **Firmware Upgrade** button in the **Upgrade selected InstaShow S button** field.

Button Firmware Upgrade

Button firmware version in Host	WDC20(T)_0.60.00
Firmware File	<input checked="" type="radio"/> WDC20(T)_1.50.00 <input type="button" value="Select File"/> <input type="radio"/> from RX
Upgrade selected InstaShow S button	<input checked="" type="radio"/> B0:F1:EC:7A:BC:50 WDC20(T)_ 0.60.00 <input type="button" value="Firmware Upgrade"/>

Warning
Don't power off or press the reset button during the process of firmware upgrading.
Don't close the window during the process of firmware upgrading.



When performing any type of upgrade DO NOT do any of the following:

- Power off or press the reset button on the Host or Button.
- Close the browser window of the web management interface.

Failure to follow these warnings will result in firmware upgrade failure and subsequent product failure.

To upgrade the Button's firmware directly from your Host follow the steps below:

1. Select **from RX** in the **Firmware File** field.

Button Firmware Upgrade

Button firmware version in Host	WDC20(T)_0.60.00
Firmware File	<input type="radio"/> from a local file <input type="button" value="Select File"/> <input checked="" type="radio"/> from RX
Upgrade selected InstaShow S button	<input checked="" type="radio"/> B0:F1:EC:7A:BC:50 WDC20(T)_ 0.60.00 <input type="button" value="Firmware Upgrade"/>

Warning
Don't power off or press the reset button during the process of firmware upgrading.
Don't close the window during the process of firmware upgrading.

2. Select the Button you want to upgrade and then click the **Firmware Upgrade** button in the **Upgrade selected InstaShow S button** field.

Button Firmware Upgrade

Button firmware version in Host	WDC20(T)_0.60.00
Firmware File	<input type="radio"/> from a local file <input type="button" value="Select File"/> <input type="radio"/> from RX
Upgrade selected InstaShow S button	<input checked="" type="radio"/> B0:F1:EC:7A:BC:50 WDC20(T)_ 0.60.00 <input type="button" value="Firmware Upgrade"/>

Warning
Don't power off or press the reset button during the process of firmware upgrading.
Don't close the window during the process of firmware upgrading.



When performing any type of upgrade DO NOT do any of the following:

- Power off or press the reset button on the Host or Button.
- Close the browser window of the web management interface.

Failure to follow these warnings will result in firmware upgrade failure and subsequent product failure.

Configuration Management

Configuration backup files feature the configuration settings for your Host except for the host name, SSID and wireless password settings, and pairing status. In **Configuration Management**, you can choose **Import Configuration File**, **Export Partial Configuration File**, **Export Complete Configuration File**, and **Factory Default**.

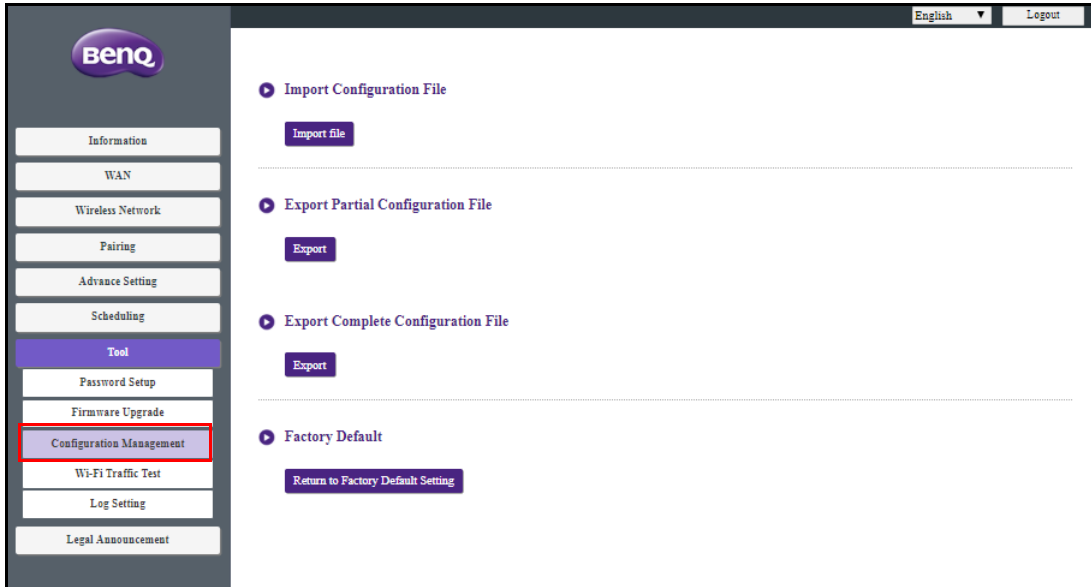

You can import configurations files by:

1. Clicking **Import File** to choose the file to import.



2. Navigating to and selecting the configuration file you want to import from your local computer. You can export a partial configuration backup in the **Export Partial Configuration File** sub-menu by:

1. Clicking **Export**.



2. Navigating to the folder you want to save the backup file to in your local computer and then choosing **Save**.
3. The following set values will not be exported:

a.	Information: Host Name
b.	Wireless Network: SSID setting and password setting
c.	Pairing: Pairing Status

You can export a full configuration backup in the **Export Complete Configuration File** sub-menu by:

1. Clicking **Export**.



2. Navigating to the folder you want to save the backup file to in your local computer and then choosing **Save**.



The exported configuration file can only be imported by the same Host that exported the file. The configuration file cannot be imported by any other Hosts.

You can have the Host restore to **Factory Default** by clicking **Return to Factory Default Setting**.



When the process is confirmed the Host will begin restoring to **Factory Default** and the LED will quick flash red (flash red twice every second) then restart. After the Host restarts the entire process is complete.

Wi-Fi Traffic Test

The **Wi-Fi Traffic Test** sub-menu allow you to test the speed of the connection between your Host and the Button.

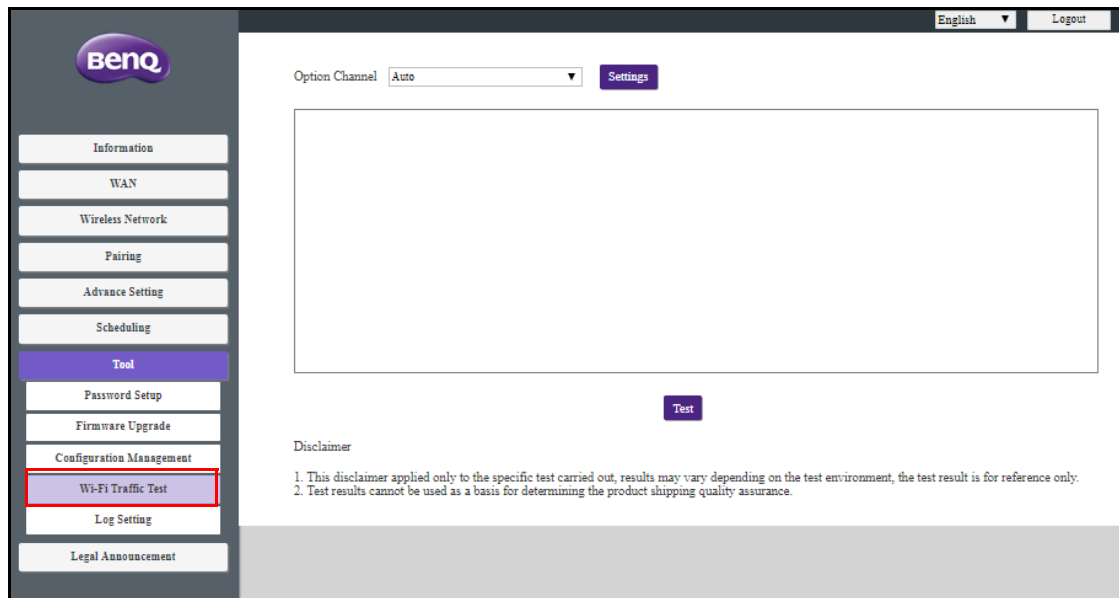

To test the speed of the connection follow the steps below:

1. Select the channel you want to test the speed of in the **Option Channel** field.

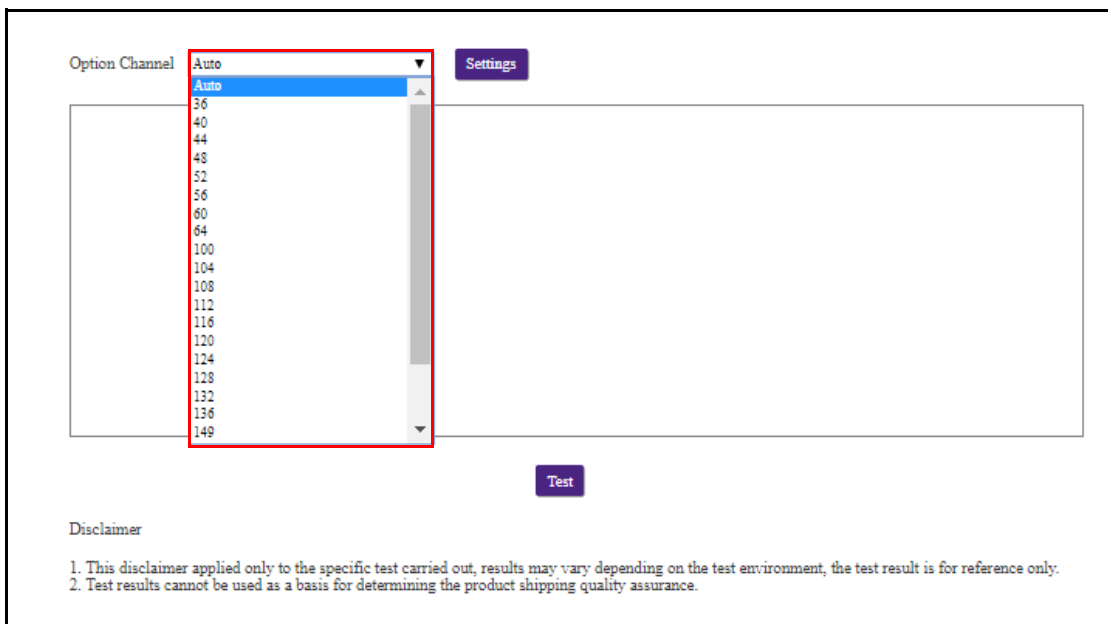

2. Click the **Settings** button to set the channel test.

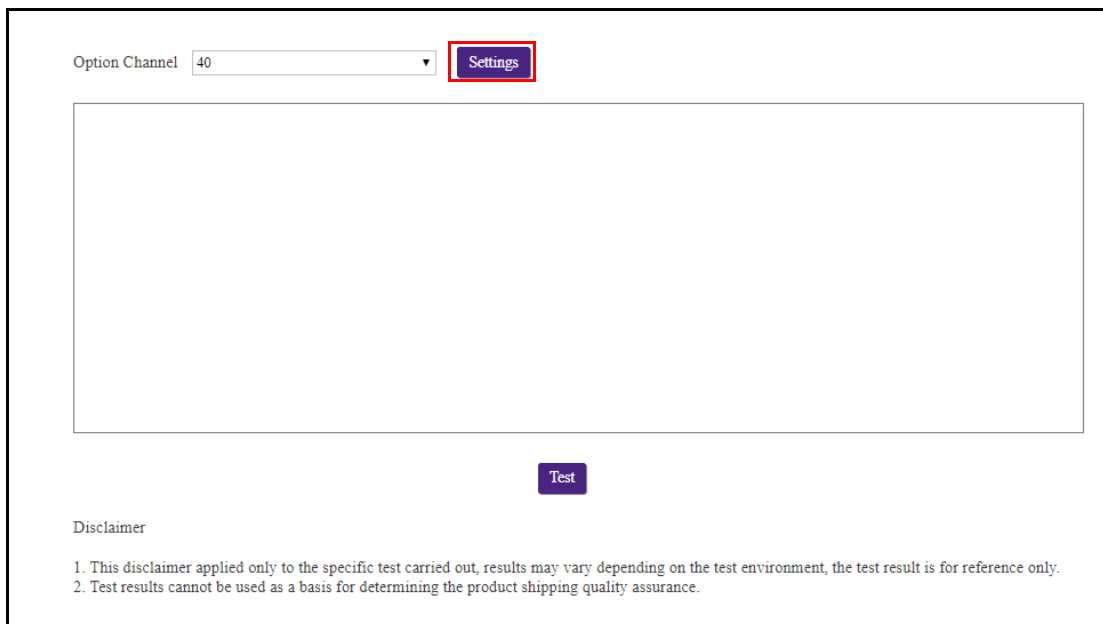

3. Click the **Test** button. The results of the test will be shown in the main window.

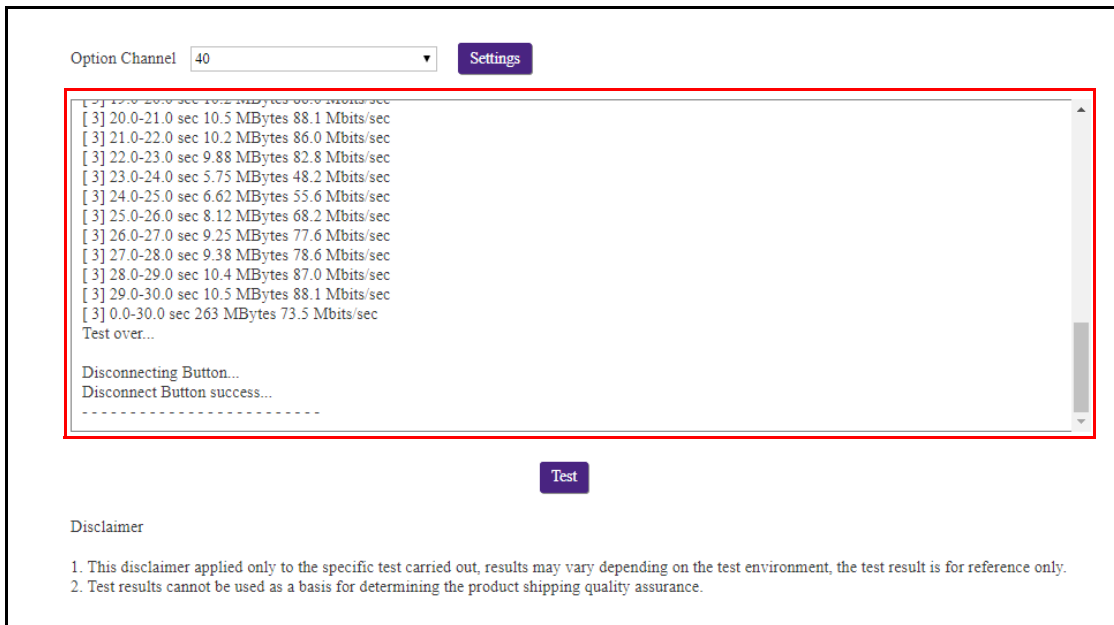
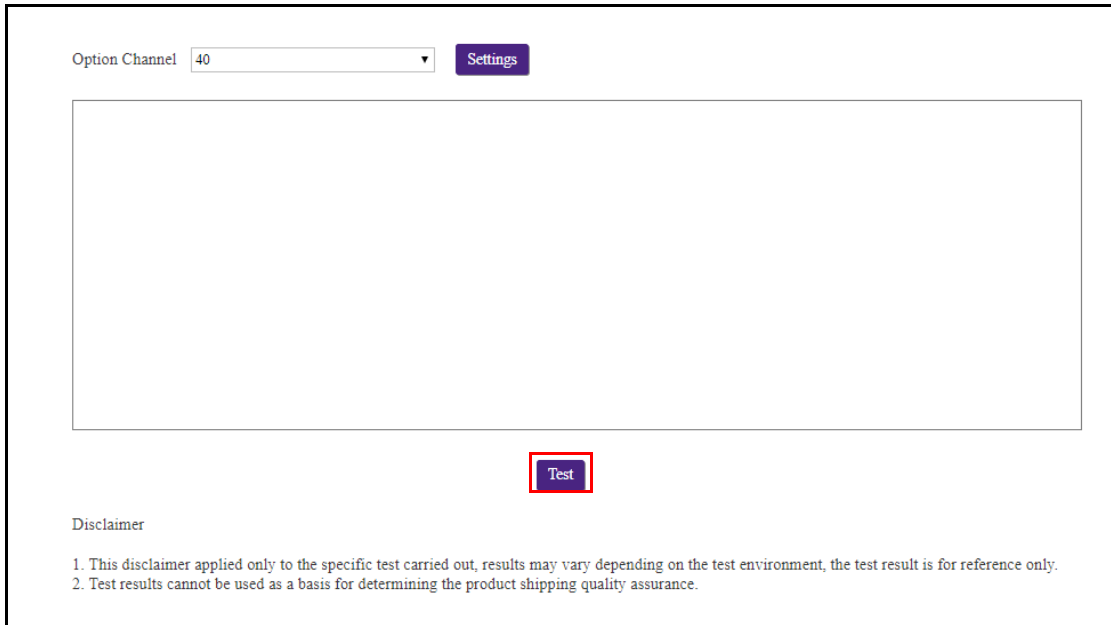

Log Setting

Logs are records of all system activity for your Host, which may be used by support technicians to track errors or locate bugs. In the **Log Setting** menu, download the system log to your local computer by clicking **Download To PC**, clear the system log by clicking **Clear Log**, and view the system log in the **System Log View** window.

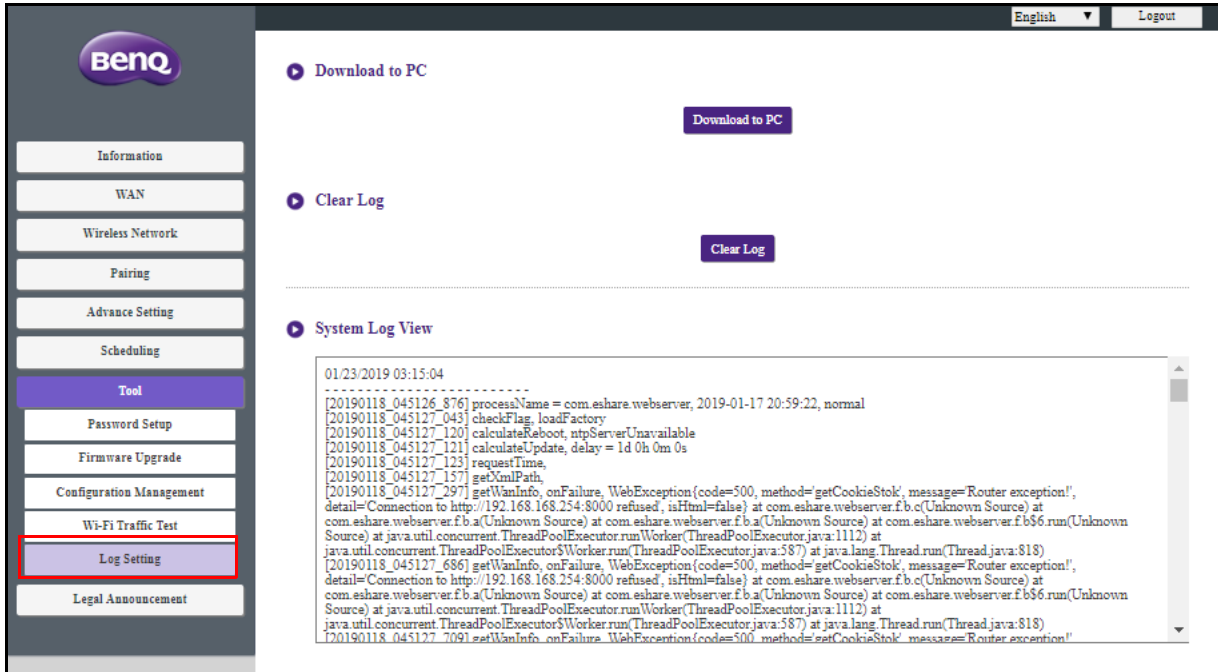

Legal Announcement

For information about disclaimer or privacy policy, press **Legal Announcement** to find out more.

Troubleshooting

Category	Problem	Cause	Solution
Your screen	Your screen is not appearing on the display when pressing the Button.	The system is locked.	Web Management > Advanced Setting> Screen Lock > Disable
		The Button is connecting to another Host.	The Button should be paired again with the Host.
		Pressing time is not enough.	Press the Present key until the LED indicator turns from green to blue.
	The screen turns blank or flickers when the Host is presenting.	Insufficient power supply	Make sure the product's power is properly supplied or connected.
	The screen lags seriously and the audio breaks up sometimes.	Insufficient power supply for the Button. An laptop with USB 2.0 port may be used as the power supply for the Button.	<ul style="list-style-type: none"> • Make sure you use USB 3.0 as the power supply for the Button. • If the USB 2.0 port is the only option for the power supply for the Button, try to reduce the power consumption of the Button by changing Picture Quality Mode to Low Power in the web management.
		Wi-Fi interference or signal attenuation	<ul style="list-style-type: none"> • Make sure the transmission distance is within 15M and with no obstacles. • Restart the Host in order to rescan the Wi-Fi 5G channel. • Log in Web Management > Wireless Network > Wi-Fi Radio Setup > toggle the Rescan button.

Category	Problem	Cause	Solution
Your screen	The message, "No Signal", from the Host is shown on the display when the Button is presenting, or your screen is blank gray.	The HDMI connection between your laptop and the Button is loose.	Reconnect the HDMI cable of the Button.
		Your laptop cannot detect the second monitor.	<ul style="list-style-type: none"> • Reconnect the USB cable of the Button. • Reboot your laptop.
	Your screen is shown, but your audio is not playing on the audio system of the meeting room.	The audio signal on your laptop is muted.	Right click on the speaker icon and switch off the mute.
		The audio output of the laptop hasn't been set to the second screen (BenQ InstaShow™ S) from the EDID of the Button.	Change the default audio output to the second screen (BenQ InstaShow™ S) on the laptop.
The Button	Your content is removed from the display and the LED indicator of your Button is blinking red.	The wireless connection is lost between the Button and Host.	<ol style="list-style-type: none"> 1. The Host will restore the Wi-Fi connection automatically. 2. If this fails, the LED indicator of your Button starts blinking red. 3. Unplug the Button from your laptop and try again.
		Wi-Fi interference or signal attenuation	Make sure the transmission distance is within 15M and with no obstacles.
	The LED indicator of the Button is blinking red when the power is on.	The Host has not been turned on.	Make sure the Host is turned on.
		The Host has not paired with a Button.	The Host should pair with the Button again.
		Wi-Fi interference or signal attenuation	Make sure the transmission distance is within 15M and with no obstacles.
	The LED indicator of the Button is always off.	There is no power supply.	Check the USB port of your laptop. If the port fails to function, try other USB ports.

Category	Problem	Cause	Solution
The Button	The Button automatically restarts sometimes.	Insufficient power supply.	<ul style="list-style-type: none"> • Make sure you use USB 3.0 as the power supply for the Button. • If the USB 2.0 port is the only option for the power supply for the Button, try to reduce the power consumption of the Button by changing Picture Quality Mode to Low Power in Web Management.
	The LED indicator on the Button remains static red even after it has been powered on for 30 seconds.	The Button has not been properly powered off during the resetting process	Reset the Button.
	The pairing function cannot be executed via the MODE key while the Button is powered on and the LED starts flashing red.		
The Host	Nothing is shown on the display at all.	The display is switched off.	Switch on the display.
		The wrong input is selected.	Select the correct input.
		The display cable is not connected properly.	Insert the HDMI cable between the Host and the display device again.
		The display fails to show the Host's output resolution at 1080p in "Guide Screen" or "Idle Screen".	Replace the display with a new one that supports output resolution at 1080p.
		The Host is in Network Standby Mode when network standby function is enabled.	Press the Present key of the Button to start presentation.

Category	Problem	Cause	Solution
The Host	Nothing is shown on the display at all.	The Host is in HDMI Standby Mode when HDMI standby function is enabled.	Briefly press the standby button on the Host or power on the display (connected to the Host with an HDMI cable). The Host will wake up automatically.
		The Host is powered off.	Briefly press the standby button on the Host.
		Insufficient power supply	Change power supply of Host to a power adapter.
	The LED indicator on the Host remains static red even after it has been powered on for 30 seconds.	The Host has not been properly powered off during the resetting process	Reset the Host.
EDID	After connecting the Button to your laptop, the second screen (InstaShow™ S) cannot be detected.	The HDMI connection between your laptop and the Button is loose.	Reconnect the HDMI cable of the Button.
		Laptop problem	Reboot your laptop.
		The Button is shutdown.	Reconnect the USB cable of the Button.
Pairing	The message, "Pairing failed", from the Host is shown on the display when the Host is pairing with the Button.	1. Error: 004 2. The Host has reached the maximum number of pairing.	Log into the web management, then select Pairing Status > Delete Delete unnecessary pairings.
		Wi-Fi interference or signal attenuation	Make sure the transmission distance is within 15M and with no obstacles.
		The Button has not entered the pairing mode in time.	When the Host enters pairing mode, the Button should also enter pairing mode within two minutes.
Windows Software	When presenting a video file via Gom Media Player, the full-screen image is cut into upper and lower halves.	Media player	Use other media players to play video files, such as Windows Media Player.

Category	Problem	Cause	Solution
Web management	Cannot Log in	Forget the account and password.	<ol style="list-style-type: none"> 1. Reset the Host. 2. The default log in account: admin 3. The default log in password: 0000.
	Laptop cannot connect the SSID with the correct password by Wi-Fi.	Laptop Wi-Fi module cannot support 802.11 AC.	Laptop can connect to the Host with an Ethernet cable instead of Wi-Fi connection.