

# artsound

## Operating Manual **MX-120M**

### MIXER AMPLIFIER WITH AUDIO SOURCES

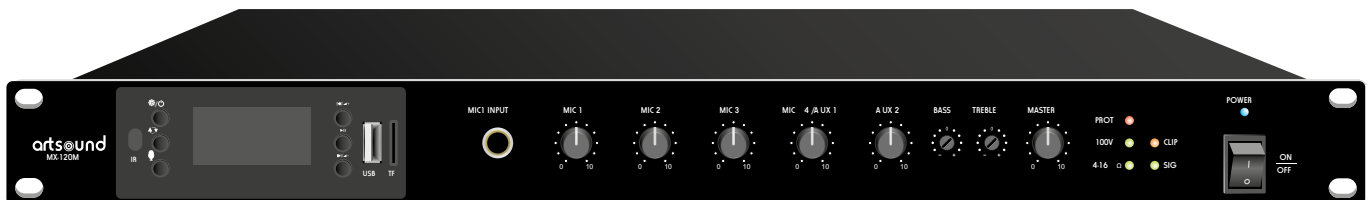

Please follow the instructions in this manual to obtain the optimum results from this unit.  
We also recommend that you keep this manual handy for future reference

Check our website for any updates of this manual: [www.artsound.be](http://www.artsound.be)

House of Music nv  
Ronse, Belgium  
[www.artsound.be](http://www.artsound.be)  
Tel. +32 9 380 81 80  
Fax. +32 9 386 12 35  
[info@artsound.be](mailto:info@artsound.be)

**Table of contents**

<b>1. Safety precautions</b>	<b>3</b>
<b>2. General description</b>	<b>4</b>
<b>3. Features</b>	<b>4</b>
<b>4. Nomenclature and functions</b>	<b>5</b>
<b>4.1 front panel</b>	<b>5</b>
<b>4.2 Remote control</b>	<b>5</b>
<b>4.3 rear panel</b>	<b>6</b>
<b>5. Operation illustration</b>	<b>6</b>
<b>6. Troubleshooting</b>	<b>8</b>
<b>7. Specifications</b>	<b>8</b>
<b>8. Applications</b>	<b>9</b>
<b>9. Block diagram</b>	<b>10</b>
<b>10. Dimensional diagram</b>	<b>11</b>

## 1 Safety precautions.

- Be sure to read the instructions in this section carefully before use.
- Make sure to observe the instructions in this manual as the conventions of safety symbols and messages regarded as very important precautions are included.
- We also recommend you keep this instruction manual handy for future reference.

## Warnings and safety.

### Safety Symbol and Message Conventions.

Safety symbols and messages described below are used in this manual to prevent bodily injury and property damage, which could result from mishandling. Before operating your product, read this manual first and understand the safety symbols and messages so you are thoroughly aware of the potential safety risk.



#### **WARNING**

**Indicates a potentially hazardous situation which, if mishandled, could result in death or serious personal injury.**



#### **CAUTION**

**Indicates a potentially hazardous situation which, if mishandled, could result in moderate or minor personal injury, and/or property damage.**

## Warning.

### When Installing the Unit.

- Do not expose the unit to rain or an environment where it may be splashed by water or other liquids, as doing so may result in fire or electric shock.
- Use the unit only with the voltage specified on the unit. Using a voltage higher than that which is specified may result in fire or electric shock.
- Do not cut, kink, otherwise damage nor modify the power supply cord. In addition, avoid using the power cord in close proximity to heaters, and never place heavy objects -- including the unit itself -- on the power cord, as doing so may result in fire or electric shock.
- Be sure to replace the unit's terminal cover after connection completion. Because high voltage is applied to the speaker terminals, never touch these terminals to avoid electric shock.
- Be sure to ground to the safety ground (earth) terminal to avoid electric shock. Never ground to a gas pipe as a catastrophic disaster may result.
- Avoid installing or mounting the unit in unstable locations, such as on a rickety table or a slanted surface. Doing so may result in the unit falling down, causing personal injury and/or property damage.

### When the Unit is in Use.

- Should the following irregularity be found during use, immediately switch off the power, disconnect the power supply plug from the AC outlet and contact your nearest ArtSound dealer. Make no further attempt to operate the unit in this condition as this may cause fire or electric shock.
  - If you detect smoke or a strange smell coming from the unit.
  - If water or any metallic object gets into the unit
  - If the unit falls, or the unit case breaks
  - If the power supply cord is damaged (exposure of the core, disconnection, etc.)
  - If it is malfunctioning (no tone sounds.)
- To prevent a fire or electric shock, never open nor remove the unit case as there are high voltage components inside the unit. Refer all servicing to your nearest ArtSound dealer.
- Do not place cups, bowls, or other containers of liquid or metallic objects on top of the unit. If they accidentally spill into the unit, this may cause a fire or electric shock.
- Do not insert nor drop metallic objects or flammable materials in the ventilation slots of the unit's cover, as this may result in fire or electric shock.

## Caution.

### When Installing the Unit.

- Never plug in nor remove the power supply plug with wet hands, as doing so may cause electric shock.
- When unplugging the power supply cord, be sure to grasp the power supply plug; never pull on the cord itself. Operating the unit with a damaged power supply cord may cause a fire or electric shock.
- When moving the unit, be sure to remove its power supply cord from the wall outlet. Moving the unit with the power cord connected to the outlet may cause damage to the power cord, resulting in fire or electric shock. When removing the power cord, be sure to hold its plug to pull.
- Do not block the ventilation slots in the unit's cover. Doing so may cause heat to build up inside the unit and result in fire.
- Avoid installing the unit in humid or dusty locations, in locations exposed to the direct sunlight, near the heaters, or in locations generating sooty smoke or steam as doing otherwise may result in fire or electric shock.

### When the Unit is in Use.

- Do not place heavy objects on the unit as this may cause it to fall or break which may result in personal injury and/or property damage. In addition, the object itself may fall off and cause injury and/or damage.
- Make sure that the volume control is set to minimum position before power is switched on.
- Loud noise produced at high volume when power is switched on can impair hearing.
- Do not operate the unit for an extended period of time with the sound distorting. This is an indication of a malfunction, which in turn can cause heat to generate and result in a fire.
- Contact your ArtSound dealer as to the cleaning. If dust is allowed to accumulate in the unit over a long period of time, a fire or damage to the unit may result.
- If dust accumulates on the power supply plug or in the wall AC outlet, a fire may result. Clean it periodically. In addition, insert the plug in the wall outlet securely.
- Switch off the power, and unplug the power supply plug from the AC outlet for safety purposes when cleaning or leaving the unit unused for 10 days or more. Doing otherwise may cause a fire or electric shock.

**An all-pole mains switch with a contact separation of at least 3 mm in each pole shall be incorporated in the electrical installation of the building.**

Due to product upgrades, while some of the features and specification in the user manual does not match the actual functions, sorry for any inconvenience and thanks for your kind understanding!

## 2. General description.

This product is a mixer amplifier with Bluetooth radio, adopting by combination of high-performance switching power supply and digital power amplifier, with 1U chassis design, high efficiency, light weight & delicate appearance.

## 3. Features

- With 1U chassis design, internal combination of switching power supply and digital power amplifier higher efficiency, light weight and delicate appearance.
- MP3 decoding module supports automatic switching of USB/SD/Bluetooth/FM playback, configure MP3 remote control; support power-off memory function, MIC recording function.
- Support 1 channel EMC input, 2 channels AUX input, 4 channels MIC input.
- Each input has independent volume adjustment with treble, bass, and volume control.
- The equipment is equipped with level indication, overload and protection indicator, and has good protection for short circuit, overload and overheat situation.
- With mute function, microphone input, microphone is prior to line input; mute function, MIC1 is prior to other audio inputs, EMC takes precedence over all audio inputs.
- Channel priority function: EMC>MIC1>MIC2/MIC3/MIC4/AUX1/AUX2/MP3.
- Adopt advanced and high-efficiency power amplify circuit, the speaker output is 100V or 4 ohms; rated output power is 120W.
- Input AC power, power supply 180W.
- It is forced to air-cool from front to the rear, and it rotates at a constant speed when starting up. It speeds up as the temperature rises and can work for a long time.

## 4. Nomenclature and functions.

### 4.1 Front panel

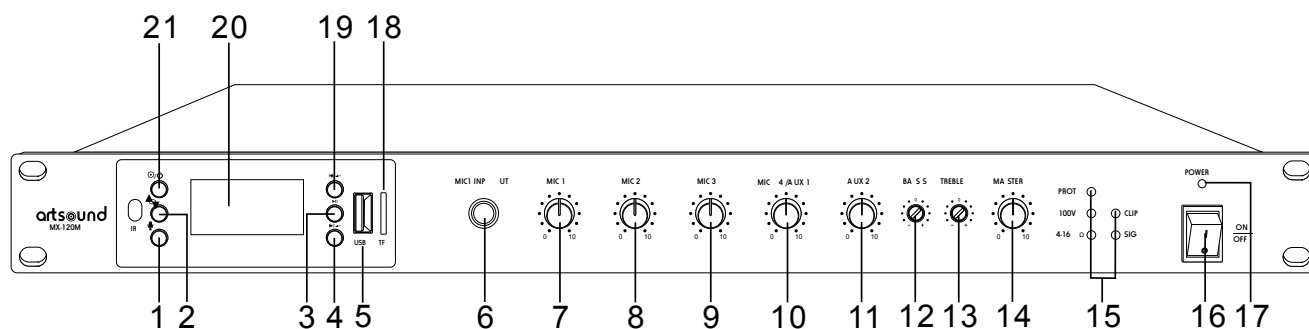

- |                               |  |                         |
|-------------------------------|--|-------------------------|
| 1. Record button              | 9. MIC3 volume control knob                    | 16. The power switch    |
| 2. Repeated button            | 10. MIC4 / AUX1 volume control knob            | 17. The power indicator |
| 3. Playback / Pause           | 11. AUX2 volume control knob                   | 18. SD / MMC card slot  |
| 4. Next / volume reduce       | 12. BASS adjustment potentiometer              | 19. PREV /volume plus   |
| 5. USB interface              | 13. TREBLE adjustment potentiometer            | 20. LED display         |
| 6. MIC1 unbalanced input jack | 14. Master volume control                      | 21. MP3 mode selection  |
| 7. MIC1 volume control knob   | 15. PROT/100V/4-16Ω/CLIP/SIG status indicators |                         |
| 8. MIC2 volume control knob   |  |                         |

### 4.2 Remote control

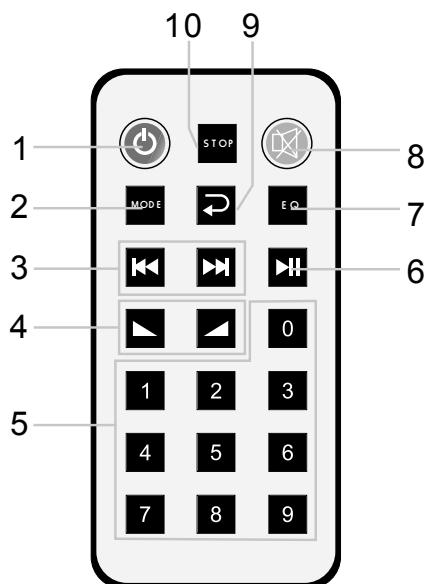

- |                             |                      |
|-----------------------------|----------------------|
| 1. Power switch             | 8. Mute              |
| 2. Mode                     | 9. Cycle play button |
| 3. Previous/next            | 10. Pause            |
| 4. Volume increase/decrease |                      |
| 5. 0~9 number button        |                      |
| 6. Play/pause               |                      |
| 7. Sound effect control     |                      |

#### Normal usage distance of remote control:

Remote control distance: 8 meter, angle: level  $\pm 35^\circ$ , vertical  $\pm 15^\circ$ .

#### Remote control usage attention:

1. When install battery, please mind electrode.
2. Please let remote control aim right with window of host machine.
3. When found remote distance get short and insensitive, please change battery.
4. Please take out battery when don't use it for a long time.
5. Take it easy in case of falling.

4.3 Rear panel.

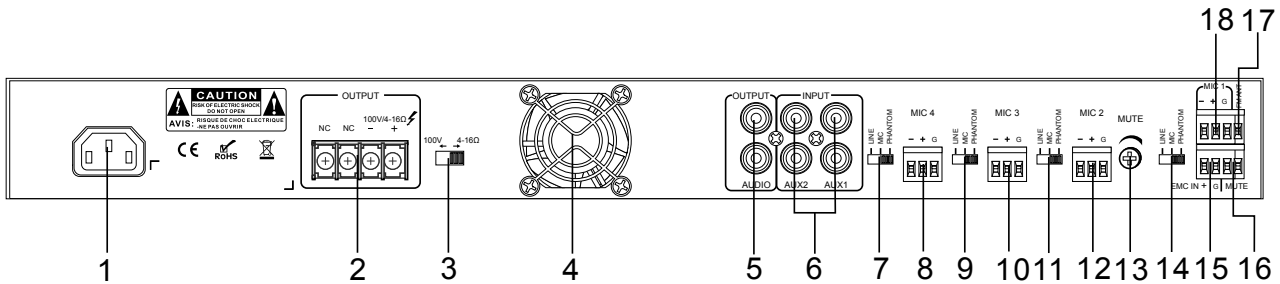

- |  |  |
|--|--|
| <ol style="list-style-type: none"> <li>1. AC power input socket</li> <li>2. 100V/4-16 Ω output interface</li> <li>3. 100V / 4-16Ω speaker output switch</li> <li>4. Cooling fan</li> <li>5. Line output interface, used to connect the line input interface</li> <li>6. 2 channel AUX input interface, used to connect AUX output interface</li> <li>7. Line input /Mic input /Phantom power switch for MIC4</li> <li>8. MIC4/AUX1 Balance input</li> <li>9. Line input /Mic input /Phantom power switch for MIC3</li> </ol> | <ol style="list-style-type: none"> <li>10. MIC3 Balance input</li> <li>11. Line input /Mic input /Phantom power switch for MIC2</li> <li>12. MIC2 Balance input</li> <li>13. MUTE control switch</li> <li>14. Line input /Mic input /Phantom power switch for MIC1</li> <li>15. EMC input interface</li> <li>16. MUTE signal input port</li> <li>17. FM radio antenna interface</li> <li>18. MIC1 Balance input</li> </ol> |
|--|--|

5. Operation illustration.

1 Connect the speakers

- When the 100V and 4-16Ω selector switch to 100V position, as shown below:
- When the 100V and 4-16Ω selector switch to 4-16Ω position, as shown below:

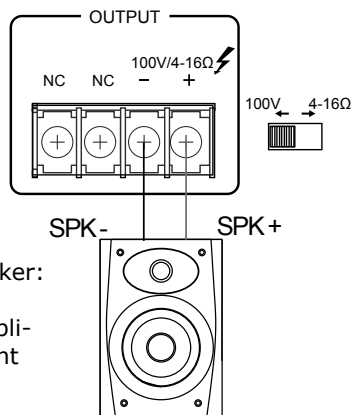

Constant pressure speaker:  
According to the rated power of the power amplifier, connect the constant power speaker.

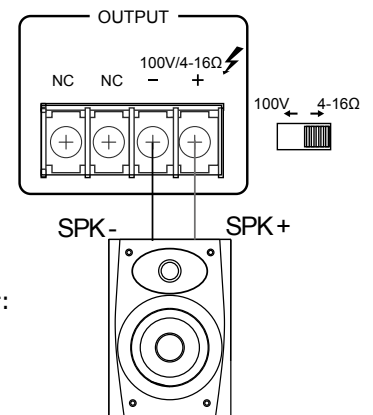

Fixed resistance speaker:  
4-16Ω



**NOTE**

- Before connecting the speakers, please make sure that the equipment is powered off. In the case of power on, may have the risk of electric shock.
- Please make sure there are no applied load to the speaker cables.
- During the installation of speakers, please make sure that the sum of the rated input power of the speakers to be connected is less than rated power of equipment.

2 Connect external devices

- Please ensure that the equipment and all equipment will be connected are powered off.
- Using the corresponding cable to connect this equipment and other external equipment.

### 3 Connect the power line and turn it on:

- Please make sure that the power switch of equipment and its connected equipment are turned off (in the OFF position).
- Turn the volume knob to the left
- Connect the supplied power line to the AC IN interface
- Plug the power line into the applicable socket
- Turn on the connected equipment (CD player, etc.), and then turn on the equipment.



#### NOTE

- **Before powering on, please check and make sure there is no problem with the cable and connection.**
- **When you turn off the system, turn off the equipment, and then turn off the connected equipment.**

### 4 Use of microphone

- Turning the volume knob to the left, Connect the microphone and microphone input interface.
- Turning the volume knob in the right position.
- Facing the microphone and Speak loudly, turn the volume knob to the right, until the output signal no longer distortion. If input is high but output is low voice, and then increase the volume by using the volume knob. If the speaker volume is very high, then reduce the volume by using the volume knob.

### 5 Shutdown the system

- Turning the volume knob to the left until the minimum position.
- Turning off the panel power switch of the professional power amplifier, at Off. In turn shutoff processor equipment and audio source equipment.



#### NOTE

- **Turn off the power switch, Please wait about 5 seconds before turning on again. Continuous rapid turning on and off the power switch, it will lead to equipment failure.**
- **Even the switch is in the off status, there will be a little current in equipment. If it won't use the equipment in a long time, please unplug the power cord from the wall AC socket.**

### 6 Built-in MP3 player operation method:

- USB and SD card interface with functions of "priority to automatically play audio".
- MODE"button: press the "MODE": choose radio, bluetooth or audio playback.
- ⏮ button : if press quickly, it is last song; Long press is the volume decrease.
- ⏸ button: when playing music, press one time quickly is pause, press again is play.
- ⏭ button: if press quickly, it is next song; Long press is the volume increase.
- 🎤 button: Long press; record audio signal from microphone.

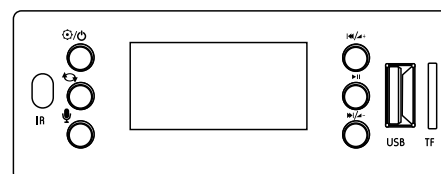

- **When using the built-in MP3 player buttons, please pay attention the strength when control, avoid excessive force to cause damage of MP3 player button.**
- **When insert SD card or USB interface. Please insert in a right way, avoid the wrong way or too hard to cause the damage of the SD card or USB interface.**

### 7 Operating method of Bluetooth of Mobile phone:

- Press the "MODE" button on the MP3 player to select the setting to Bluetooth mode.
- Enter the settings of your phone and find the relevant settings for Bluetooth.
- Tap the Bluetooth switch to turn it on. If it is already on, you can ignore it. The setup interface may vary slightly from different phone systems.
- Note that after the phone Bluetooth is turned on, the search for the Bluetooth paired phone must be set to allow all devices to detect, otherwise the search pairing may not be completed.
- After searching for the MX-120M device, click on the searched MX-120M device, it will automatically connect and pair. After the pairing is completed, the phone music could be played normally.

### 8. The FM radio operation description:

First, connect the antenna that is packaged with the product to the "ANT" port on the rear panel of the machine through the Phoenix terminal. The other end of the antenna is placed in an open space, such as the side window, and then set the working mode of the MP3 module on the machine to FM mode. Search for stations and save them automatically by pressing the play/pause button on the machine panel or on the remote control. After the automatic search of the standby device is completed, select the station that you like to listen to by pressing the previous song or the next song button on the machine panel or on the remote control. (Remarks: The machine has a power-off memory function, and the FM frequency range is: 87.50-108.00MHz)

### 6. Troubleshooting

Failure phenomena	Failure cause
1. Power switch is not opened	<ul style="list-style-type: none"> <li>• Power line is cut off</li> <li>• The protection function of the equipment is not activated</li> </ul>
2. All lines are connected, but there is no sound.	<ul style="list-style-type: none"> <li>• The power switch is not opened or the power plug is bad contacted.</li> <li>• The fuse is burnt</li> <li>• The volume knob is not opened or turned down to a extra low level</li> <li>• There is no audio signal input</li> <li>• There is short-circuit in the speaker line.</li> </ul>
3. The sound suddenly disappears in normal status.	<ul style="list-style-type: none"> <li>• The equipment is in very high temperature to make it into protection status.</li> <li>• The connection wire is bad contact.</li> </ul>
4. Low sound	<ul style="list-style-type: none"> <li>• The equipment is set to be low impedance connection, but the speakers connected is with high impedance.</li> </ul>
5. The sound is distorted	<ul style="list-style-type: none"> <li>• The input level of Mic or external equipment is too high</li> </ul>

### 7. Specifications.

Model	MX-120M
Rated Power	120W
Output Level	4-16Ω/100V
Input sensitivity	MIC1,2,3,4 input:5mV±1mV/600Ω, balanced European terminal; AUX1,2 input:350mV±20mV/10KΩ, unbalanced RCA connection terminal; EMC input:775mV±40mV/10K balanced European terminal
Output Sensitivity& Impedance	MIX OUT: 1000mV/470Ω unbalanced RCA connection terminal
Tones	Bass:±10dB at 100Hz Treble:±10dB at 10KHz High frequency:±10dB at 10KHz
Frequency response	80Hz~16KHz(+1dB,-3dB)
Signal-to-noise ratio	MIC: ≥65dB; Music:≥70dB
Cross talk attenuation	≥50dB
SNR S/N Ratio	MIC1,2,3:66dB / AUX1, 2:85dB
THD	≤0.05%(at 1KHz, 1/3 rated power)
Indicator	Power indicator
Cooling Mode	Forced fan to cool after side entry, boot to start the fan, and do the variable speed processing infinitely.
Protection Mode	Overheat protection, overcurrent protection, short circuit protection
Operation Temperature	+5°C~+40°C
Storage Temperature	-20°C~+70°C
Relative Humidity	<95%(No condensation)
Voltage	~230V 50Hz
Power consumption	180W
Weight	4.7Kg
Dimensions	484×295×44mm



## 8. Applications.

### REAR PANEL CONNECTIONS

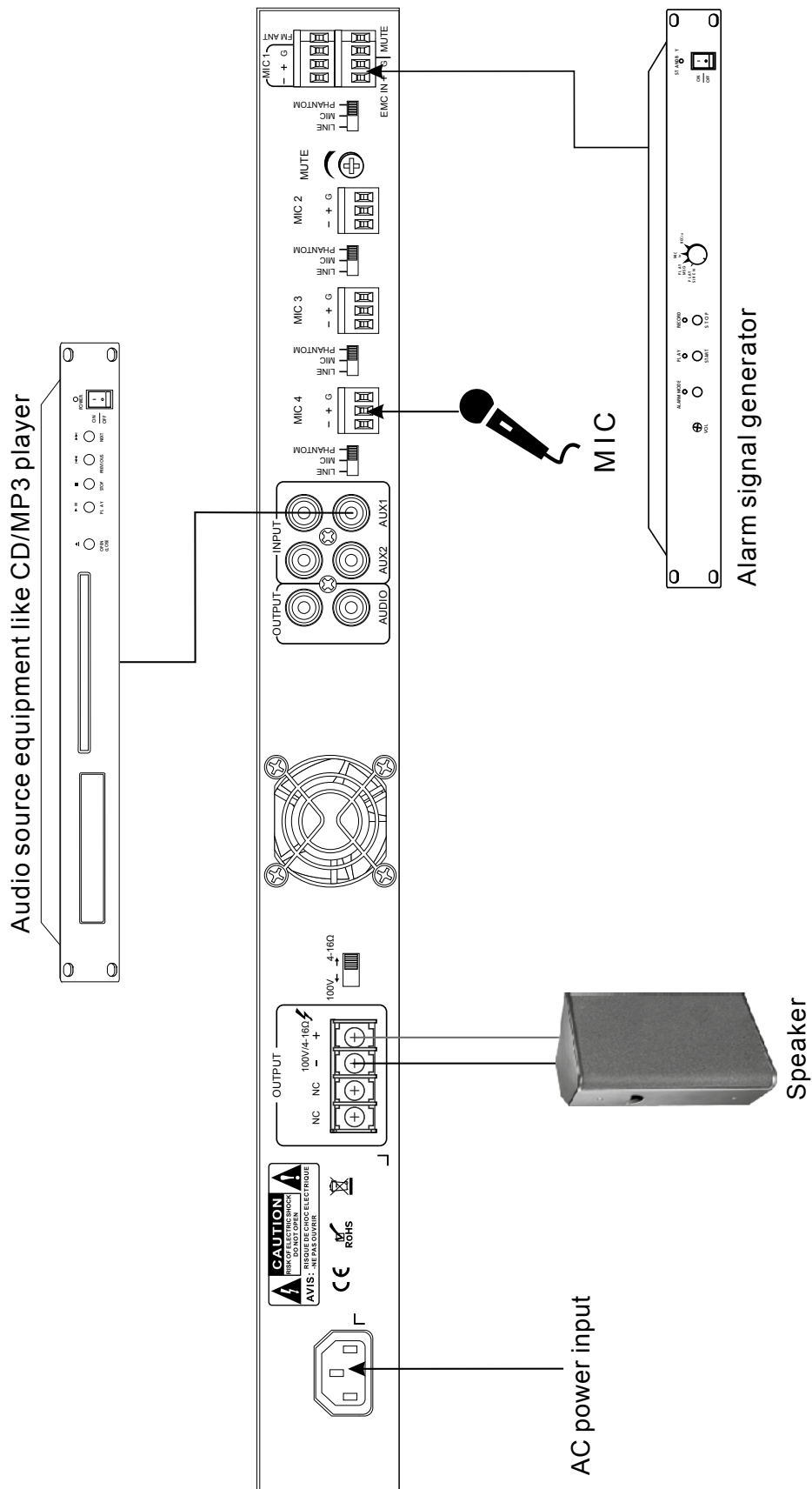

9. Block diagram.

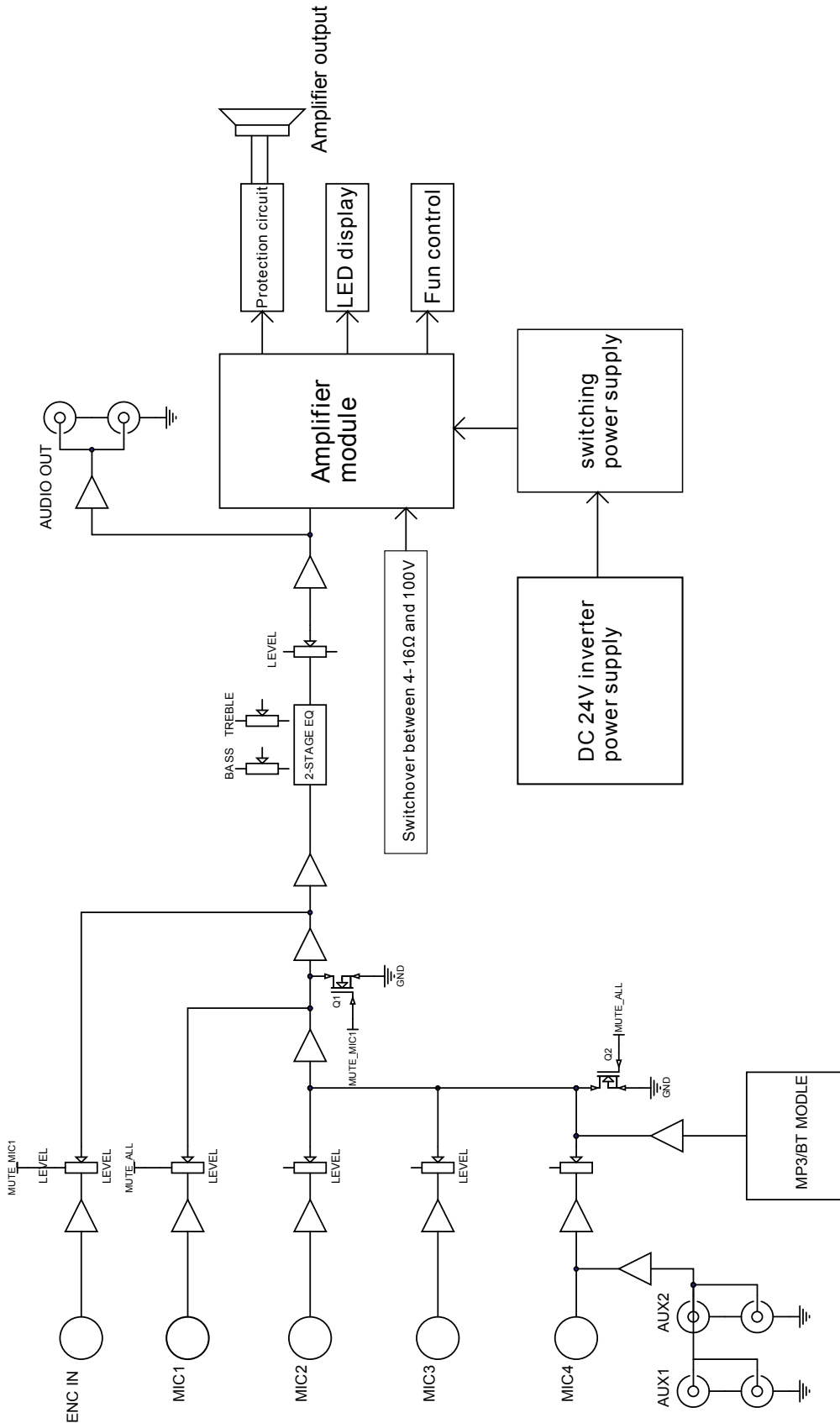

### 10. Dimensional diagram.

UNIT : mm

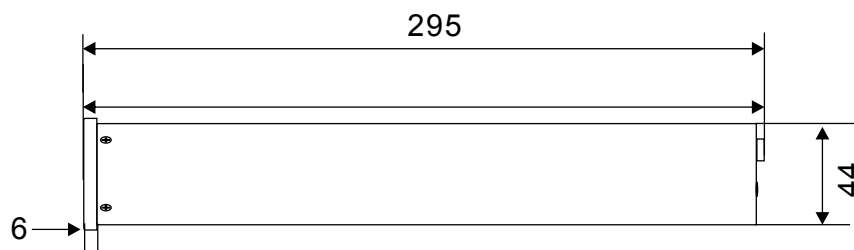
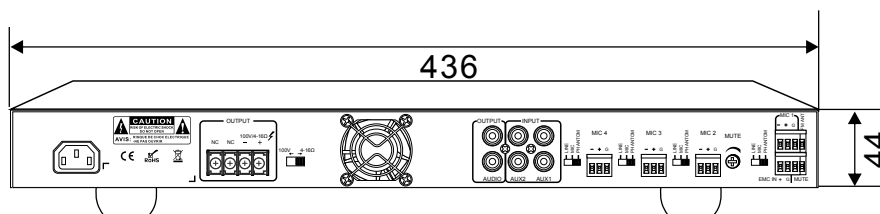
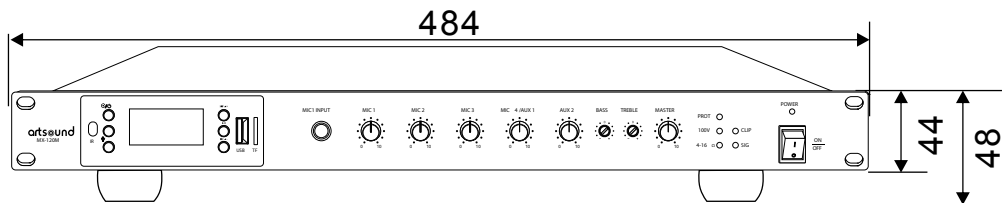

Keep the unit's all sides over 10 cm away from objects that may obstruct air flow to prevent the unit's internal temperature rise.

UNIT : mm

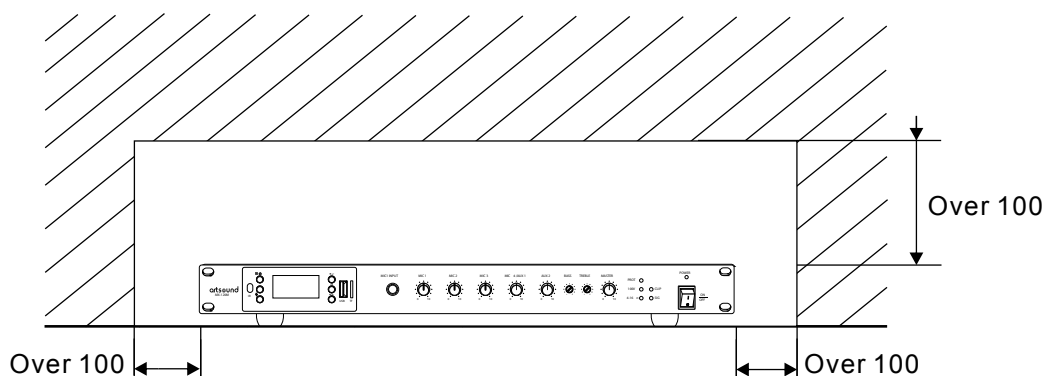



# artsound

smart solutions in audio

**Discover the complete ArtSound  
range at [www.artsound.be](http://www.artsound.be)**

---

 [www.artsound.be](http://www.artsound.be)  
 [Artsound.audio](https://www.facebook.com/Artsound.audio)  
 [artsoundaudio](https://www.instagram.com/artsoundaudio)

artsound  
smart solutions in audio

House of Music nv  
Ronse, Belgium  
Tel. +32 9 380 81 80 - Fax. +32 9 386 12 35  
[info@houseofmusic.be](mailto:info@houseofmusic.be)