



DSP-AEC-1010-DA

Audio DSP with AEC

4-in/4-out analog, 4-in/4-out Dante and USB

All Rights Reserved

Version: DSP-AEC-1010-DA_2021V1.0

Preface

Read this user manual carefully before using the product. Pictures shown in this manual are for reference only. Different models and specifications are subject to real product.

This manual is only for operation instruction, please contact the local distributor for maintenance assistance. The functions described in this version were updated till Sep 2021. In the constant effort to improve the product, we reserve the right to make functions or parameters changes without notice or obligation. Please refer to the dealers for the latest details.

FCC Statement

This equipment generates, uses and can radiate radio frequency energy and, if not installed and used in accordance with the instructions, may cause harmful interference to radio communications. It has been tested and found to comply with the limits for a Class A digital device, pursuant to part 15 of the FCC Rules. These limits are designed to provide reasonable protection against harmful interference in a commercial installation.

Operation of this equipment in a residential area is likely to cause interference, in which case the user at their own expense will be required to take whatever measures may be necessary to correct the interference.

Any changes or modifications not expressly approved by the manufacture would void the user's authority to operate the equipment.



Table of contents

1. Technology Overview	5
1.1 Introduction to Technology	5
1.2 About Dante AES67	5
1.3 Audio Input Section	5
1.4 Audio Output Section	5
1.5 Floating Point DSP	6
1.6 Typical System Application	6
2. Hardware	7
2.1 Safety Instructions	7
2.2 Audio Wiring Reference	8
2.3 Specifications	9
2.4 Mechanical Data	10
2.5 Front Panel	10
2.6 Rear Panel	10
3. Software	12
3.1 Software Installation	12
3.2 Using the Software	12
3.3 Audio Parameters	13
3.3.1 Input Source	13
3.3.2 Expander	14
3.3.3 Compressor & Limiter	14
3.3.4 Auto Gain Control	15
3.3.5 Equalizers	16
3.3.6 Feedback filters	17
3.3.7 AutoMixer	18
3.3.8 Acoustic Echo Cancellation (AEC)	19
3.3.9 Automatic Noise Suppression (ANS)	20
3.3.10 Matrix	20
3.3.11 High & Low Pass Filter	21
3.3.12 Delay	21
3.3.13 Output	21
3.3.14 USB Soundcard	22

Audio DSP with AEC, 4-in/4-out analog, 4-in/4-out Dante and USB

3.4 Setting Menu	23
3.4.1 File Menu	23
3.4.2 Device Setting	24
3.4.3 Group Setting	24
3.4.4 Panel Setting	25
3.4.5 Dante Setting	26
3.4.6 Help Menu	27
4. Control	27
4.1 External Control Programmer	27
4.2 Control Protocol	28
4.3 Serial Port-to-UDP (RS232 To UDP)	30
Appendix B: Module Parameter Types (1)	32
Appendix B: Module Parameter Types (2)	34
5. Customer Service	36

1. Technology Overview

1.1 Introduction to Technology

The Tight AV DSP system is a fixed architecture signal processing platform with powerful signal processing and routing options. The hardware is equipped with analog audio interface connectivity, as well as digital audio using Dante for audio over Ethernet and USB-audio as an interface for computers.

Tight AV DSP 1.0 is a Windows-based application used to configure and control the DSP hardware. An easy-to-use GUI gives the user fast access to all the available processing functions. The unit has 16 built-in presets that can store the complete configuration for later recall.

The Tight AV DSP can be controlled via the software, a dedicated wall panel controller or from 3rd party systems using the API control protocol over RS-232/485 or Ethernet.

1.2 About Dante AES67

Dante/AES67 audio networking utilize standard IP networks to transmit high-quality, uncompressed audio with near-zero latency. It's the most economical, versatile, and easy-to-use audio networking solution, and is scalable from simple installations to large-capacity networks running thousands of audio channels. Dante/AES67 can replace multiple analog or multicore cables with a single affordable Ethernet cable to transmit high quality multi-channel audio safely and reliably. With Dante software, the network can be easily expanded and reconfigured with just a few mouse clicks. Dante/AES67 is the audio networking choice of nearly all professional audio manufacturers, with hundreds of Dante-enabled audio products now available.

For more information, please visit the Audinate website at www.audinate.com.

1.3 Audio Input Section

The DSP supports up to 4 balanced analog audio inputs available on removable phoenix connectors. The analog input section supports microphone or line-level signals. +48VDC phantom power can be adopted for each input.



Preamp gain and phantom power can be conveniently controlled via Tight AV DSP 1.0 software.

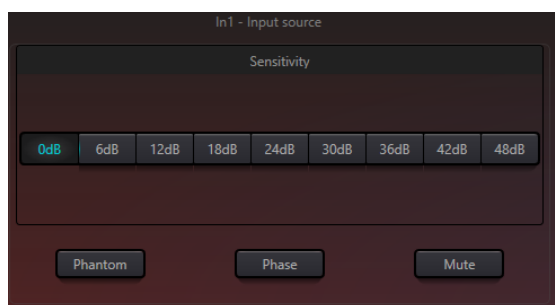

1.4 Audio Output Section

The analog output section offers 4 balanced channels available on removable phoenix connectors. 24bit D/A conversion provides excellent signal to noise ratio. With input and output faders set to 0dB the unit operates at unity gain. Nominal output level is +4dBu with 20dB headroom. 0dBFS digital signal is equivalent to +24dBu.

1.5 Floating Point DSP

The signal processing is done in an Analog Devices SHARC DSP, enabling 32-bit and 40-bit floating-point processing. Floating-point processing provides advantages for the users in terms of sound quality and usability.

With floating point processing the internal calculations of the DSP will have higher dynamic range and avoid rounding errors that can be a cause of noise.

1.6 Typical System Application

Meeting Room System: Tabletop or ceiling microphones, with local output to amplifier and speakers. Wireless microphones via Dante, audio over Ethernet. The output signal can also transmit to a recording device with Dante interface e.g., a computer with Dante virtual soundcard. Volume control and preset recall can be done from a wall panel controller.

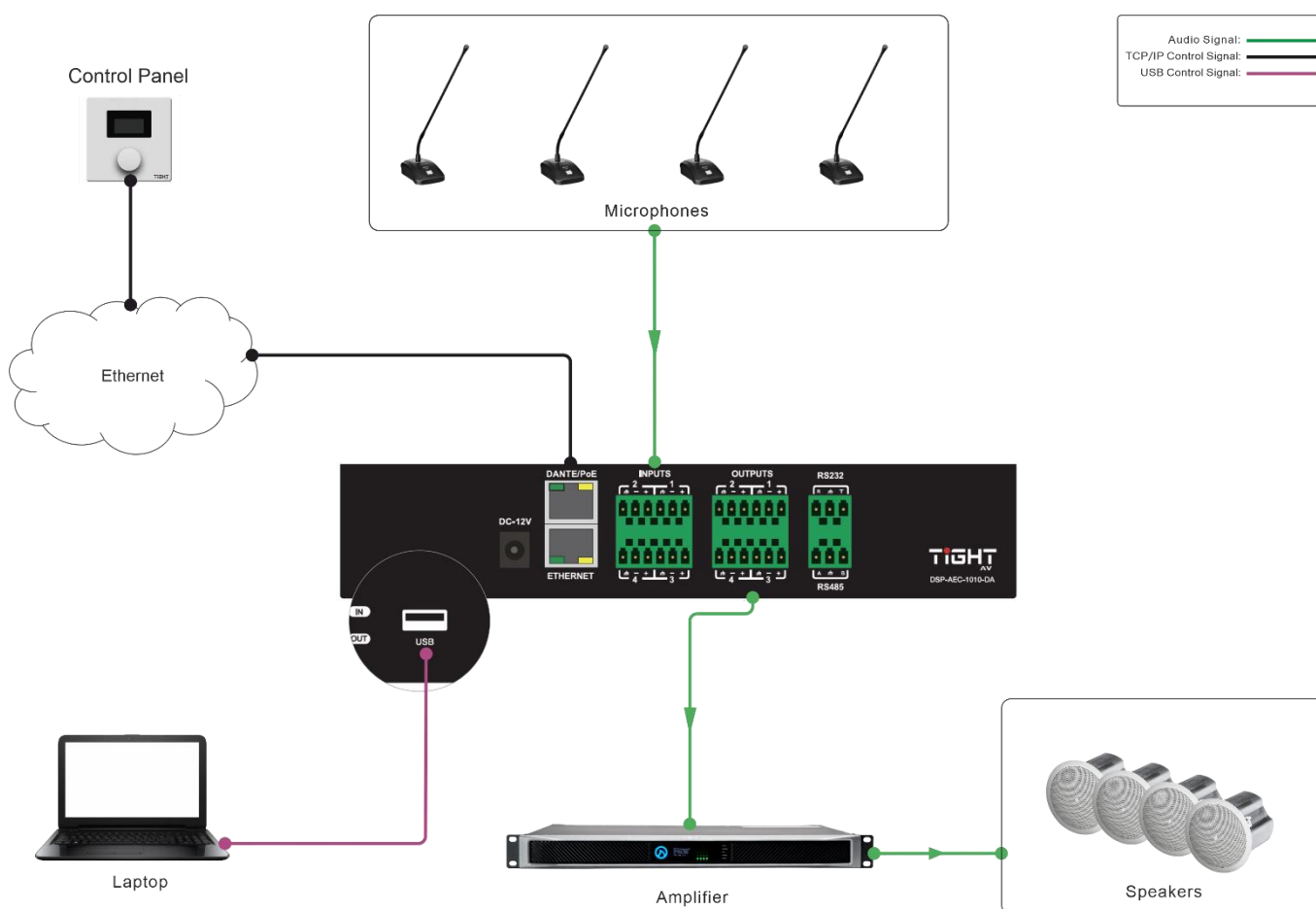

Dante Application: Dante enables easy integration of compatible devices over a network. Possible sources and destinations include microphones, mixers, music players and amplifiers, recorders and streaming devices.

2. Hardware

2.1 Safety Instructions

Safety Instructions

Important safety instructions:

1. Read these instructions.
2. Keep these instructions well.
3. Pay attention to all warnings.
4. Follow all instructions.
5. Please keep the device away from water. The device shall not be exposed to water drips or water splashes; make sure that there is no object with liquid near the device, such as vase.
6. Please use dry cloth to clean up the device.
7. Please do not block the vent. Please get the device installed based on the manufacturer's instructions.
8. Please do not install any heat source, such as radiator, heat register, furnace or other devices (including amplifiers) that generate heat.
9. Please adopt protective grounding connection to connect the device to the power socket. Please do not use polarized plug or grounding plug. A polarized plug has two leaves, and one is wider than another. A grounding plug has two leaves and a third ground terminal. The wide leaf or third ground terminal can provide safety for the users. If the plug provided does not accord to the power socket, please contact the electrician to replace the old socket with a new one.
10. Protect the power cord so that it will not be tramped or protruded, especially the plug, the socket and the connections of cord and device.
11. Please use the accessories designated by the manufacturer.
12. Please only use the cart, the tripod, the holder or the desk designated by the manufacturer or sold together with the device. When using the cart, please take care with the mobile cart/device to avoid injury from rollover.
13. Please unplug the device during a thunderstorm or during the idle period.
14. Please find qualified maintenance personnel to deal with all maintenance problems. When the device gets damaged in any manner, the maintenance is required. For example, the power cord gets damaged, liquid spill or the object falls into the device; the device is exposed to the rainwater or moisture; the operations are not correct, or the device falls off.

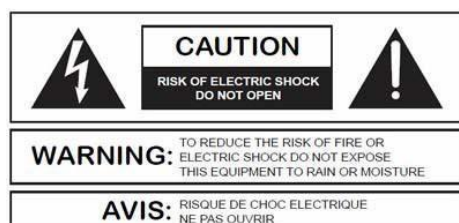

SEE OWNERS MANUAL. VOIR CAHIER D'INSTRUCTIONS.
No user serviceable parts inside. Refer servicing to qualified service personnel.
Il ne se trouve à l'intérieur aucune pièce pouvant être réparée l'utilisateur.
S'adresser à un réparateur compétent.

The lightning logo (an equilateral triangle with an arrow) is used to make the users aware of the uninsulated "dangerous voltage" within the product shell, which may cause electric shock. An equilateral triangle with an exclamation mark is adopted to make the users understand the importance of the operations and maintenance instructions given in the appendixes attached to the product.

Warning: In order to prevent electric shock, please do not use a polarized plug provided by a device with an extension cord. The socket outlet cannot be inserted except for sharp end.

2.2 Audio Wiring Reference

Balanced Connection

Any of these interfaces may occur on both sides of the connection.

Note: For one XLR interface, the female connects to the output device and the male connects to the input device.

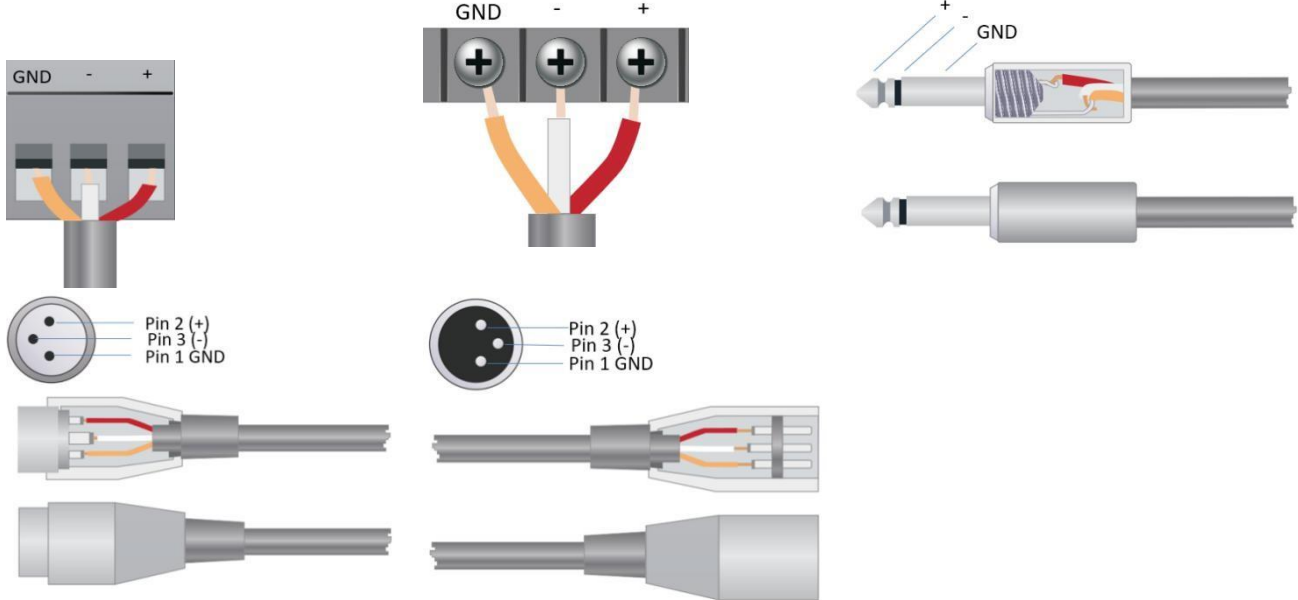

Unbalanced Connection

RCA interface and 1/4-inch TS interface are unbalanced interfaces. A multi-strand shielding conductor may be installed on both ends of unbalanced connection.

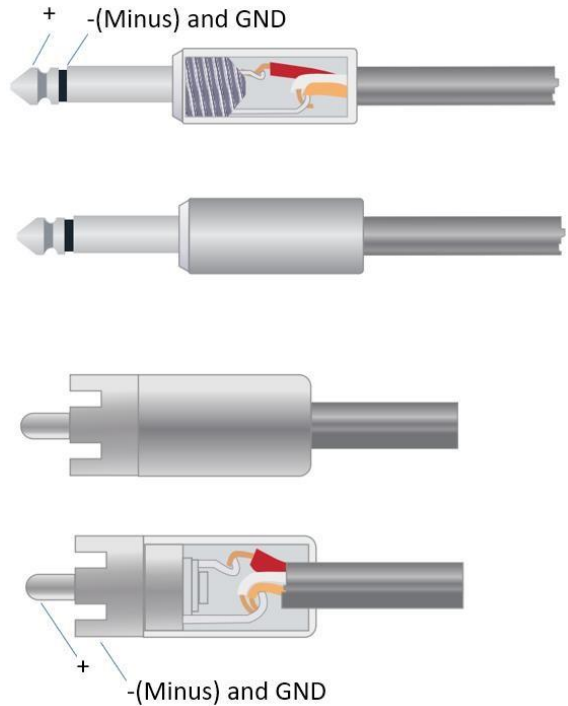

2.3 Specifications

Processor	ADI SHARC 21489
Sample rate/bit depth	48kHz/24bit
Input gain steps	0/6/12/18/24/30/36/42/48dB
Phantom Power	48V
Frequency Response (20Hz~20KHz)	±0.5dB
Maximum Level	+18dBu
THD + Noise	0.003%@4dBu
Dynamic Range	110dB
Background Noise (A-weighted)	-91dBb
Common Mode Rejection Ratio @60Hz	80dB
Channel Isolation @1KHz	108 dB
Input Impedance (Balanced Connection)	5.6kΩ
Output Impedance (Balanced Connection)	102Ω
System Delay	<3ms
Power requirements	PoE or 12V
Power adapter	AC110~240V 5Hz-60Hz, 12V DC / 2A output
Maximum Power Consumption	10W
Dimensions (Width x Depth x Height)	215 x 162 x 44mm
Shipping Weight	2kg

2.4 Mechanical Data

Space required:

1U (W x D x H: 215 x 162 x 44mm).

At least 70mm should be reserved for the connections on the rear panel. Reserved depth depends on the wire used and the connection mode.

Ventilation:

The recommended highest operating ambient temperature is 30°C / 86°F.

Make sure that there is no blockage of the venting holes on both sides of the unit. A gap of at least 5cm shall be reserved).

Electrical Property:

The unit can be powered by PoE (802.3af) or with a 12V power adapter.

Universal input power adapter: AC110~240V 5Hz-60Hz, 12V DC / 2A output.

Shipping Weight:

(2 kg)

2.5 Front Panel



Power: LED power indicator.

Run: The operation status indicator of the device.

USB AUDIO: USB soundcard for recording and playback from computer.

2.6 Rear Panel

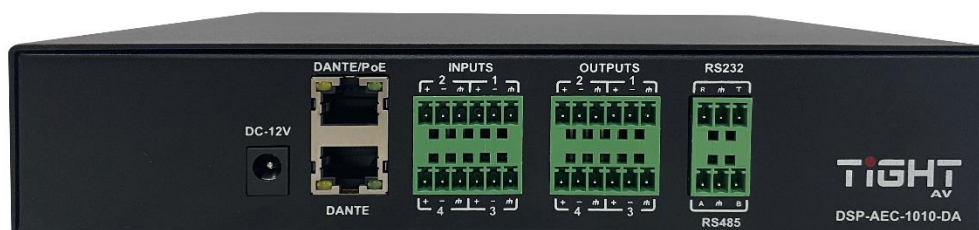

Power Source:

Power connector: 12V DC / 2A

Dante/PoE

100 Base-T Ethernet connector, provide up to 8 (4x4) channel Dante network audio. Uses the UltimoX4 chip. This interface is also used for communication with PC software and any third-party external controller.

Dante

100 Base-T Ethernet connector, switched network interface (not for redundant Dante use)

RS485

Used for the serial communication port Tx = sending or data output or Rx = receiving or data input that connects to a third-party control device.

RS485 can be used for voice tracking control (or other output commands), or for bus input control. A central command can be used to conveniently integrate it into your software.

Port setting: 115200 baud (default), 8 data bits, 1 stop bit, no parity, no flow control.

RS232

Used for serial communication with external devices. Port Tx = sending data, and Rx = receiving data input from a third-party control device.

Port setting: 115200 baud (default), 8 data bits, 1 stop bit, no parity, no flow control.

3. Software

3.1 Software Installation

A Windows PC with a processor of 1 GHz or higher and:

Windows 7 or higher version.

1 GB free storage space.

1024 x 768 resolution.

24 bit or higher color.

2GB or higher memory.

Network (Ethernet) port.

1. Download software and install files.
2. Double click the downloaded file and install by following the instructions on the screen.

After the software is installed, read other parts of the help file or execute the software.

After the software is installed, use one of the following methods to enable the software:

1. Desktop icons:
2. Start menu:

When starting the software for the first time, it may take some time (1-15s) to start it. Please wait for a while.

3.2 Using the Software

After starting the software, the main menu is shown as below:

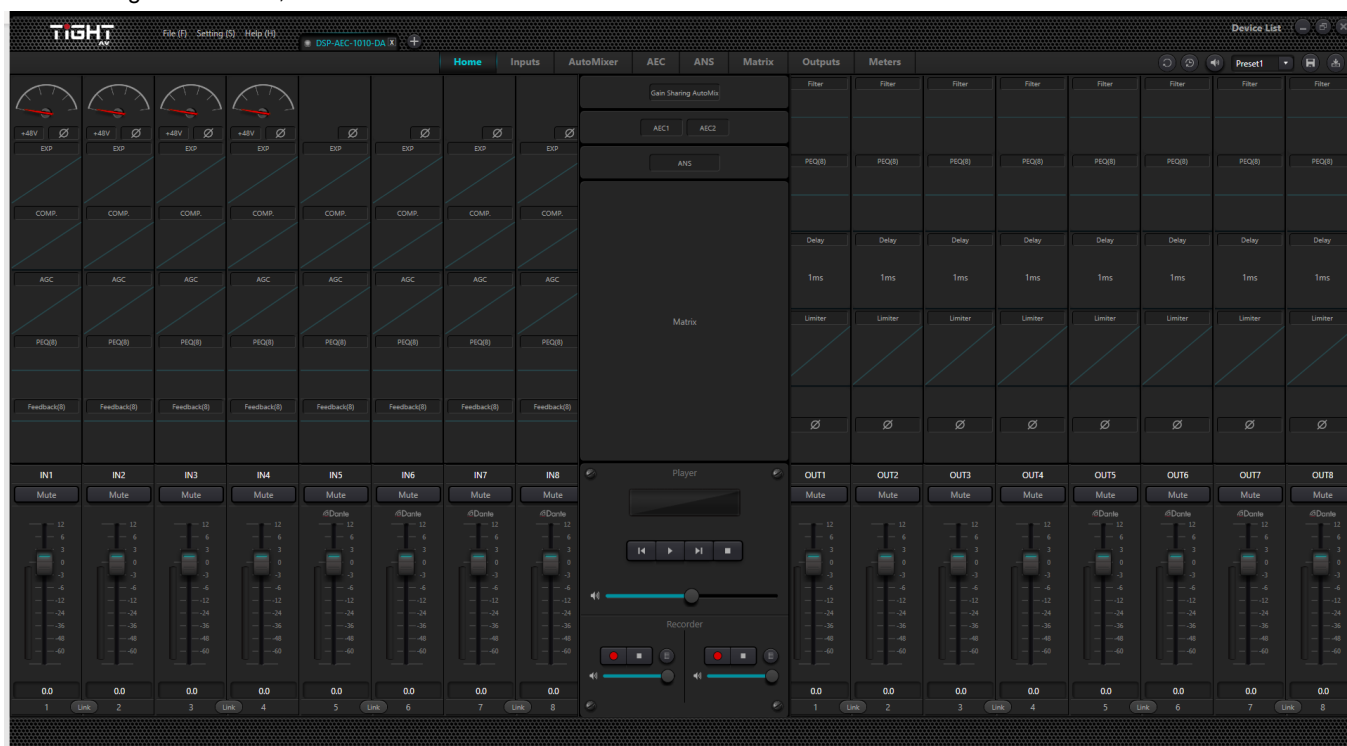

Click "Device List" in the top right corner of the main menu, to discover all processors on the network automatically.

Click “Connect” to match the device on the network with the unit in the open tab in the software. One processor supports simultaneous connection and control of up to four users.

In the “Device List” menu there are also settings for assigning static IP-address.

3.3 Audio Parameters

There are two modes for parameter editing:

- Click the input or output channel modules and enter the parameter interface of the module.
- Right click the module and the configuration interface will pop out. The first mode is adopted for the following module parameters.

3.3.1 Input Source



Sensitivity: Input gain in nine steps (0/6/12/18/24/30/36/42/48dB).

Phantom Power: Provides +48V DC power for condenser microphones. Do not enable phantom power for a line input or when the power is not required, as this may damage the external device.

Sine Wave: Click to activate tone generator. Drag the frequency slider to set frequency (20~20 kHz). Drag level slider to adjust output level (unit: dBFS). Use the slider or click the text field to set a value.

White Noise: Click to activate White noise generator. White noise has a flat frequency spectrum. Use level slider to adjust level. Frequency slider has no function in this mode.

Pink Noise: Click to activate pink noise generator. Pink noise falls off by 3dB/octave. Use level slider to adjust level. Frequency slider has no function in this mode.

Right click to copy/paste parameters between channels

Right click/Group Setting: Open the group setting interface swiftly.

Right click/Minimum and Maximum Gains: Limit the maximum and minimum of the gain of a channel.

3.3.2 Expander

The expander will reduce the signal level by the selected ratio when the signal goes below the threshold.

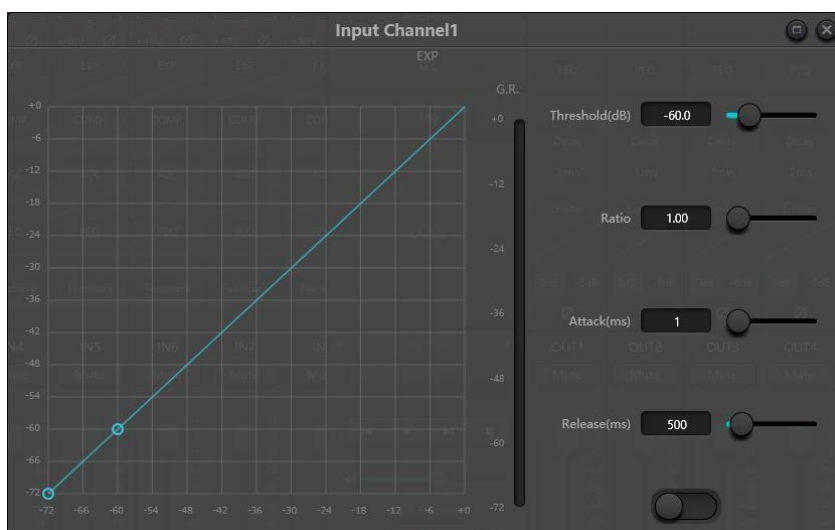

Fig.3.2 Expander The

expander has the following control parameters:

Threshold: The expander is active when the signal goes below this threshold.

Ratio: Refers to the slope below the threshold point on the gain curve. Higher ratio results in more attenuation below threshold

Attack time: Refers to the time required to activate the expander when the signal falls below the threshold.

Release time: Refers to the time required for the gain to be restored when signal is above the threshold.

3.3.3 Compressor & Limiter

Compressor

The compressor is used to reduce the dynamic range of the signal higher than the threshold and maintaining the dynamic range of the signal below the threshold.

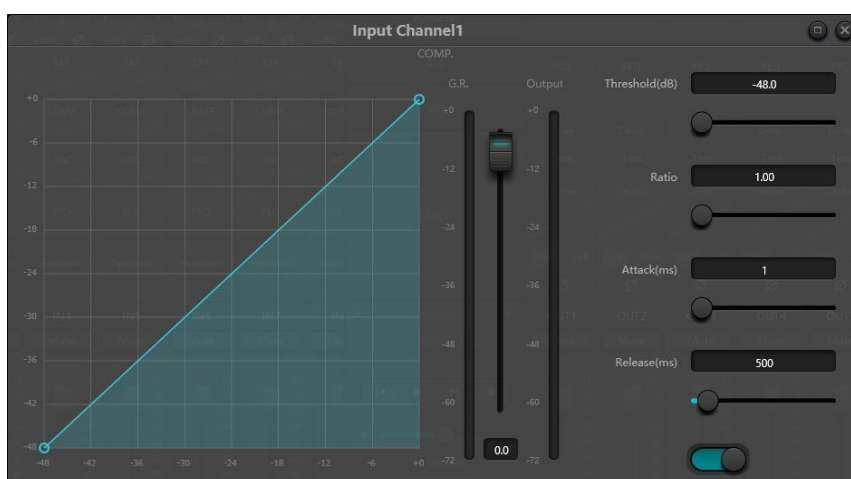

The compressor has the following control parameters:

Threshold: The compressor is active when the signal goes above this threshold.

Ratio: Refers to the compression ratio. The ratio sets the degree of gain reduction when the signal is above the threshold level. The adjustable range of compression ratio is 1-20.

Attack & Release Time: Refers to the time required to activate the compressor when the signal goes above the threshold.

Output Gain: Used to compensate for the gain reduction in the compressor.

G.R. and output Level Meter: G.R. indicates the compressors amount of gain reduction. Output refers to the output level of the signal that has passed through the compressor module. Gain reduction is displayed in an inverse level meter.

Limiter



The limiter on the outputs works in similar way as the compressor, but with a high ratio. The output level will not exceed the set threshold.

The limiter only provides two parameters: Threshold and Release Time.

3.3.4 Auto Gain Control

The Auto Gain Control (AGC) is a dynamic processor used to adjust the signal to a set target level, while maintaining the dynamic range.

The threshold is set at a very low level with middle-to-slow attack time, long release time and low ratio. The auto gain control includes silent detection to prevent unwanted changes during silent periods.

Auto gain control may e.g. be used to normalize the level of background music player.

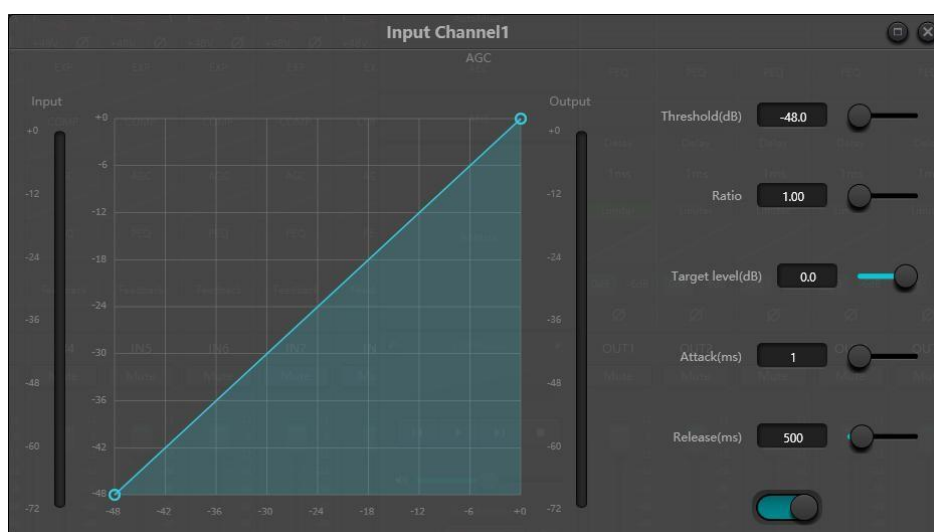

Auto gain control includes the following control parameters and switches:

Threshold: When the signal level is lower than the threshold, the input-to-output ratio is 1:1. When the signal level is higher than the threshold, the input-to-output ratio changes with the ratio control settings. The threshold should be set just above the background noise level to avoid amplification of the noise.

Ratio: Refers to the ratio of the changes in level when the input signal is higher than the threshold.

Target level: Refers to the target output level. If the signal is higher than the threshold, the controller will compress the signal proportionally.

Attack (ms): Refers to the time required to activate the AGC when the signal is above the threshold.

Release (ms): Refers to the time required for the gain to be restored when signal is below the threshold

3.3.5 Equalizers

Filter for changing the frequency balance of the signal.

The equalizer has the following control parameters:

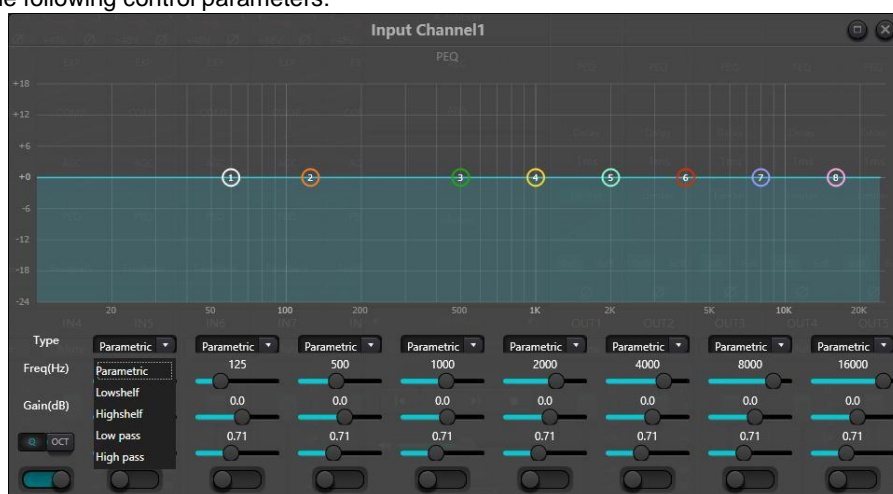

Fig.3.6 Equalizer

Type: Parametric EQ is the default filter type. Additionally, high & low shelf filters and high & low pass filters can be selected.

High & Low Pass Filter: The high-pass filter will pass through frequencies higher than the set frequency and attenuate the frequencies below this with a slope of 12dB/octave. Default Q of 0.71 gives a maximally flat amplitude (Butterworth). The low-pass filter works in a similar way but attenuating above the corner frequency.

High & Low Shelf Filter: A shelving filter will amplify or attenuate the frequencies above (high shelf) or below (low shelf) the set frequency by the amount set in the gain parameter.

Frequency (Hz): Refers to the centre frequency of the filter.

Gain (dB): Amount of gain or attenuation of the signal at the set frequency.

Q: Refers to the quality factor of a filter. The adjustable range of Q value is 0.02-50.

For a parametric EQ filter, Q value refers to the width of the bell-shaped frequency response curve on both sides of the cut-off frequency.

When the filter is a high & low shelf filter or a high & low pass filter, if $Q > 0.707$, there will be peaks in the filter responses. If $Q < 0.707$, the slope will become flatter.

The Q-factor parameter should be used with caution, as a too high value can result in a resonant filter function.

Each segment of the equalizer has a switch, used to turn on or turn off the filter. After being closed, the parameter setting will not work. The equalizer has a master switch used to enable or disable all filters.

3.3.6 Feedback filters

After setting proper levels for microphone and speakers, the feedback filter section can be used as a secondary precaution to avoid unwanted feedback. The traditional methods should still be used, such as limiting the number of open microphones, minimizing the distance between sound source and microphone, good distance between the microphone and loudspeakers, and equalizing the room speakers to get a flat response. Later, we can adopt feedback filters to get additional gain. The feedback filters cannot be used to magically solve the system's design defects or improve the sound transmission gain in a way exceeding the system's physical limitations.

The feedback filter module automatically detects and prevents feedback in the sound system. The module distinguishes feedback from expected sounds based on the characteristics of the signal. When feedback at a certain frequency is detected, a notching filter will be automatically added at this frequency to attenuate it. During the first addition, the notching filter only attenuates the feedback a bit. If the feedback still exists, the notching filter will continue to attenuate the feedback in accordance with the preset parameters until the feedback disappears or reaches the maximum preset parameter. Multiple user parameters can be used for accurate fine tuning of the effects of the module.

After tuning, the filter may be locked up to prevent any change during the performance. The filter settings can be copied to a dedicated notching filter module (parametric equalizer). Eight filters are set as auto filters in an automatic cycle. In this way, filters for temporary use can be removed.

Each channel has a feedback filter section. Click on/off button to enable or disable the filter section. Each feedback filter module has 8 narrow-band filters.



The feedback filter module has the following adjustable parameters:

Panic Threshold: According to this parameter, "any signal higher than the threshold is absolutely a feedback". When a signal level is higher than the feedback threshold, any of the following circumstances will occur:

- the output gain is temporarily attenuated to control the speed of feedback
- the output level is restricted to prevent out of control
- the filter's sensitivity is increased for faster detection and feedback

Once the output level is lower than the threshold, the gain will be recovered, and the sensitivity is restored to normal state. This value refers to the peak value of digital range signal. If the value is set as 0, this function is disabled.

Feedback Threshold: Signal below this threshold will not be analysed by the feedback filter section.

Filter Depth: Refers to the maximum attenuation of a single filter. A low setting may prevent over-processing effects caused by the filter or notching filter. It may cause worse feedback control, especially in a large narrow resonance system.

Bandwidth: 1/10 and 1/5 Octave can be chosen. The filter will not become wider due to the increase of depth. In the case of frequent feedback, the bandwidth can be set at 1/5Oct for a wider bandwidth.

Preset: There are four built-in presets: "big music room", "small music room", "big voice room" and "small voice room". These four presets apply to the default settings of most applications.

Filter Mode: Each feedback filter has three modes: dynamic, manual and fixed. When manual mode is set, the gain can also be manually set. When Fixed mode is set, the filter always works and will not be occupied by new feedback points; it still works when being rebooted. When all eight filters are used and new feedback is detected, the module will take one of the "Dynamic" filters and use this to inhibit new feedback.

Clear: Click the button to instantly clear up all filters. It will clear up all feedback points found previously.

The feedback filter section can be used as a tool during the system commissioning to identify feedback points or as a preventive measure during normal operations. If you want to get higher system transmission gain and feedback inhibition effect, it is recommended that you debug by following the steps below:

- (a) Reduce the system gain, and use the button "Clear" to reset all filter parameters
- (b) Set up parameters for the feedback filter module. Also, decrease the panic threshold to reduce the feedback level.
- (c) Open all microphones, and slowly increase system gain until the feedback occurs. Stop increasing system gain when the feedback occurs.
- (d) Wait for the feedback inhibition module to take effect; after the feedback disappears, continue to increase gain.
- (e) Repeat the operation until the system reaches the required gain or until all filters are fully distributed
- (f) Change the panic threshold to a maximum level just higher than the expected non-feedback signal.

At this time, if needed, you may set Fixed mode for each filter or save the dynamic status to deal with possible feedback during the performance period. Additionally, you may copy the filter to the notching filter module (parametric equalizer).

3.3.7 AutoMixer

A normal mixer is simply summing the signals. For every doubling of open microphones, the total gain will double. This will amplify noise and room noise leaking into unused microphones.

The gain sharing automixer solve this problem by maintaining a fixed total gain. Unused microphones will be attenuated while the microphones in use will be open, sharing the available gain.

To use the Automix, the direct routing of the microphone input channel should be disabled, and the output of the Automix should be routed to the selected destination in the matrix.

The automix function can be activated for each channel independently. Disabling the automix function for a channel will pass the signal through like a normal mixer, and not influence the automix algorithm.

There are two groups of control parameters in the automix module: main control parameters and channel control parameters.

(1) Main control parameters

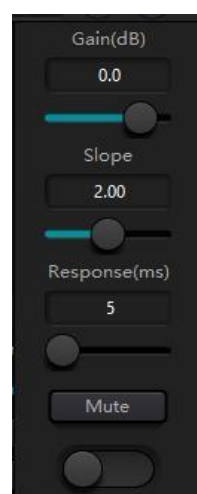

Gain: controls the main output volume of the automixer

Slope: The slope control influences the attenuation of unused channels. If the slope is higher, the level of the unused channels will be reduced. It is suggested that the value be set at or around 2.0. A slope parameter set at 1.0 will make the automixer function like a normal mixer. If set at 3.0, the action will result in larger gain reduction, which may sound unnatural. The bigger the value, the more the channel is opened and the more the total attenuation. The recommended value is around 2.0.

Response Time: Shorter response time ensure fast opening of microphones in use. Longer response time gives a smooth operation but may cut off the start of a word if set too long. In practice the best effect will be when response time is between 100ms and 1000ms. The autogain algorithm will open microphones faster than closing them. Therefore, the start of words will not be cut off even with the response time at 100ms. If set to several seconds, there will be a longer hold time of the response time in the automixer. The previous active channel will remain open for several seconds.

Mute: master mute for the automixer

On/off: button for activating or deactivating the automixer function.

(2) Channel control parameters

AutoMixer: Each channel has an automix on/off button which must be turned on for channels to participate in the automix.

Mute: Both channel mute and fader are behind auto gain. If the channel level is increased, the gain level of other channels may also be reduced even if the channel mute is on.

Gain: Gain fader for adjustment will increase/decrease the volume proportion in automix.



Priority: Priority setting for automix algorithm. Priority parameter ranges from 0 to 10. Higher value gives higher priority.

Both channel mute and fader are behind auto gain. Any adjustment made in these two parameters will not influence the operation of the automix. For example, If the channel level is higher, the level gain of other channels may be reduced even if the channel mute is on. Channel mute shall be turned on and automix shall be turned off to mute the signal and prevent its influence on the automix. Mute button at each channel shall be muted and directly connect output mute when mixing sound. Channel faders also control sound mixing level and direct output level of channels.

Priority control allows high priority channels to override low priority channels, and thus the automix algorithm will be affected. Priority value can be set from 0 (the lowest priority) to 10 (the highest priority), and the default value is 5 (standard priority). Users may use slider or click textbook to input a specified priority between 0 and 10 to adjust priority.

If two channels have the same signal level, then the channel with higher priority will get more auto gain. If there is one-unit priority between them, then the channel with higher priority will get extra sound mixing gain of 2dB (suppose the slope of the two channels is set at 2.0). For example, if channel 1 and 2's priorities are respectively set at 6 and 3, and the input level of those two channels are the same, then channel 1 will get extra sound mixing gain of 6dB than channel 2. During operation, it shall be noted that the slope setting of main control parameters will also influence sound mixing gain difference brought by the priority weight of channels. If the slope is set at 3.0, then one priority unit difference will result in gain difference of 4dB. If all channels have the same priority, then their priority settings shall be set at 5.

Note: Users should be very careful when using high priority differences between channels, such as priority of 0 and 10. If channels with high priority recognize signals like background music from speaker, then it is possible for them to mask channels with lower priority even the former is not used. It will get worse if the slope is higher. To prevent this users may consider installing a noise gate or expander between automixers at the highest priority channels. Threshold should be set at the level where it is not opened by the noise gate or expander.

3.3.8 Acoustic Echo Cancellation (AEC)

To use the AEC module, select the local microphones to be processed, select the input from the far side talker and do the appropriate routing of the AEC channel in the matrix.

Acoustic echo cancellation (AEC for short) is a type of digital audio signal processing to improve. It is used in audio/video conferencing when talkers in the local conference room are talking with one or more speakers at a remote location. AEC improves the remote talkers experience by cancelling acoustic echo generated in the local room.

Echo cancellation module for remote calls can be used for local amplification of remote voice signals and attenuate the interference caused by acoustic echo. Its basic operation principle is simulating the echo channel, calculate the echo generated by remote signals and then subtract the estimated signal from the input signal from microphones.

There is one echo cancellation module in the TIGHT DSP unit. Two local input and remote output mixers are preset to realize multichannel signal participating echo cancellation as shown in the figure. One parameter can be adjusted:

Non-linear filter (NLP): Three types including Conservative, Moderate and Aggressive can be selected to determine echo suppression levels.

Audio DSP with AEC, 4-in/4-out analog, 4-in/4-out Dante and USB

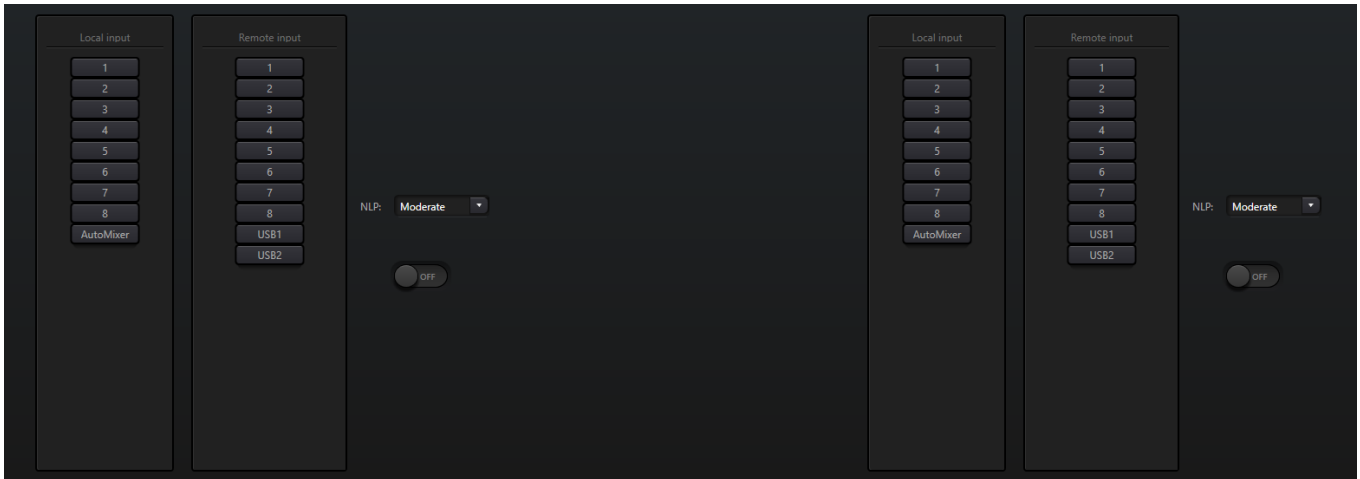

3.3.9 Automatic Noise Suppression (ANS)

The Noise suppression module can remove noise from the microphone signal. To use the ANS, the direct routing of the microphone input channel should be disabled, and the output of the ANS should be routed to the selected destination in the matrix.

There is only one noise suppression module in the DSP Controller. Select the channels to be noise cancellation as shown in the figure.

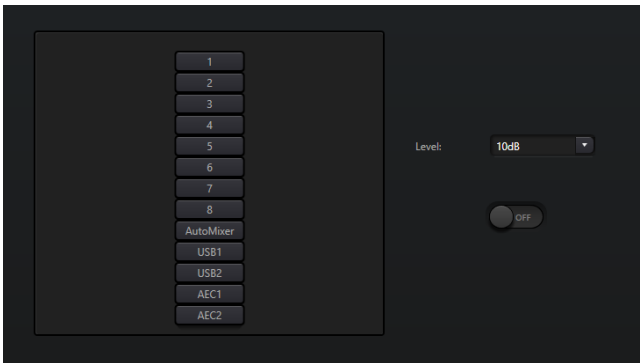

Suppression level:

There are three levels of noise reduction:

Mild(6dB), Medium(10dB) and Aggressive(15dB).

3.3.10 Matrix

The matrix is the core function for routing inputs and processing functions to the appropriate output. As shown in the figure, the horizontal direction indicates the input channels, and the vertical direction indicates output channel. One-to-one input to outputs is the default setting. Click a field to establish the new route and click again to remove it. Right-click to bring up the level control for the crosspoint. When using automixing, echo cancellation and noise suppression modules use the matrix to route the processed signal to the wanted output.

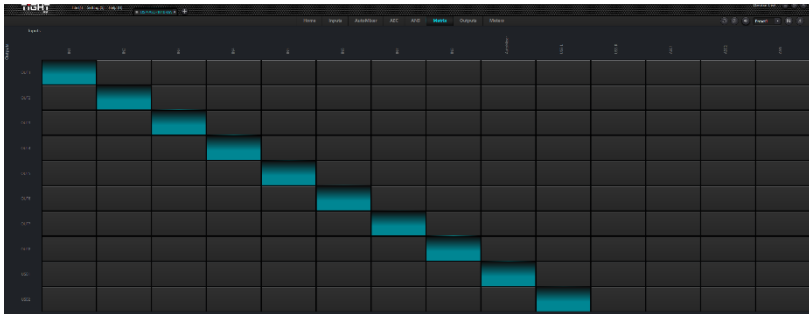

3.3.11 High & Low Pass Filter



The output channels have high- and low-pass filters. Each filter has four parameters:

Frequency: The cut-off frequency of filters. The cut-off frequency of Bessel and Butterworth is defined at -3 dB, and the cut-off frequency of Linkwitz-Riley is defined at -6dB.

Gain: Gain setting for the pass-band of the filter.

Type: There are three types of filters including Bessel, Butterworth and Linkwitz-Riley. Butterworth has the flattest passband.

Slope: Refers to the steepness of the filter in the stop-band. There are 8 slope values: 6, 12, 18, 24, 30, 36, 42 and 48dB/Oct.

Each filter section has a separate on/off button.

3.3.12 Delay



On/off: Activate the delay function on the output

Millisecond: Set delay time in milliseconds. The value ranges from 1 to 1200 milliseconds. Delay is also displayed in meter and feet.

3.3.13 Output

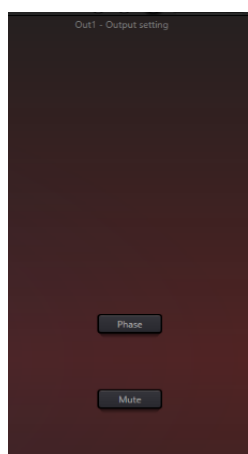

Phase: Invert signal polarity.

Mute: Mute to disable output.

Audio DSP with AEC, 4-in/4-out analog, 4-in/4-out Dante and USB

To link several outputs with a common mute and gain control, right-click the output fader and select the Group setting.



3.3.14 USB Soundcard

The USB soundcard can record and playback sound from a computer.

Useful for music playback, recording and teleconferencing using computers. Use the AEC and ANS if necessary for video conferencing applications. USB functions on the software interface can only be used for recording and file playback.

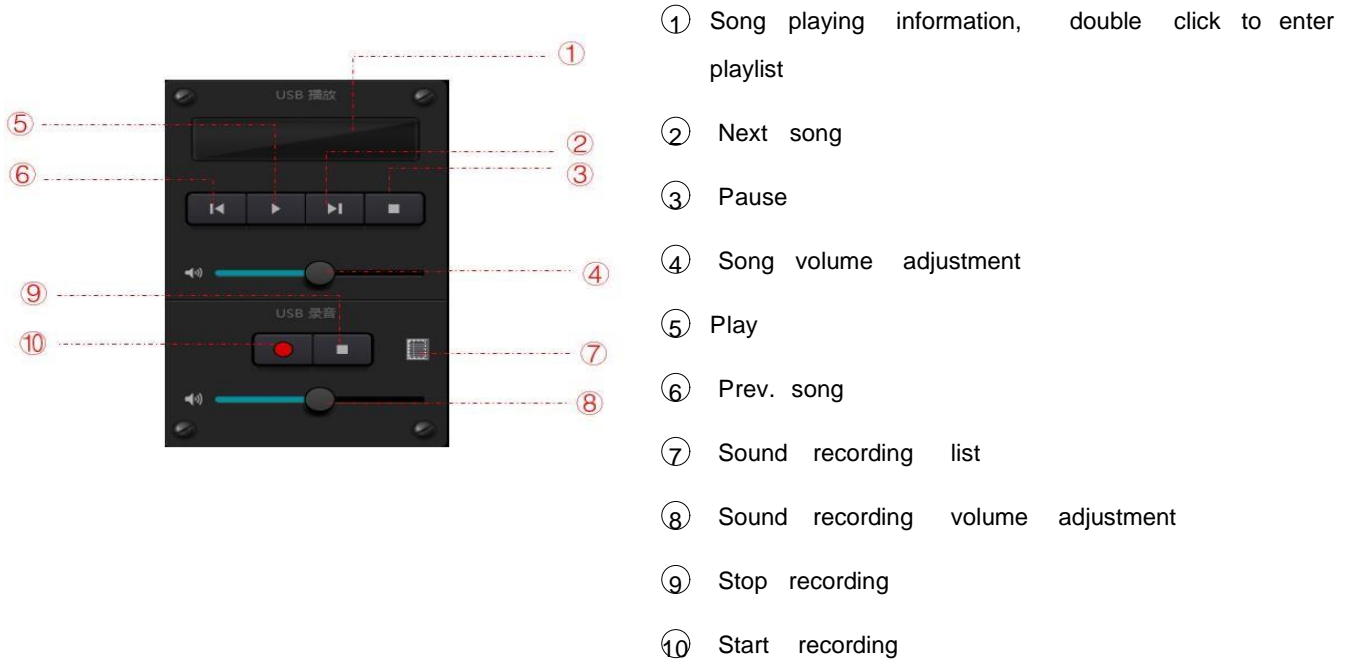

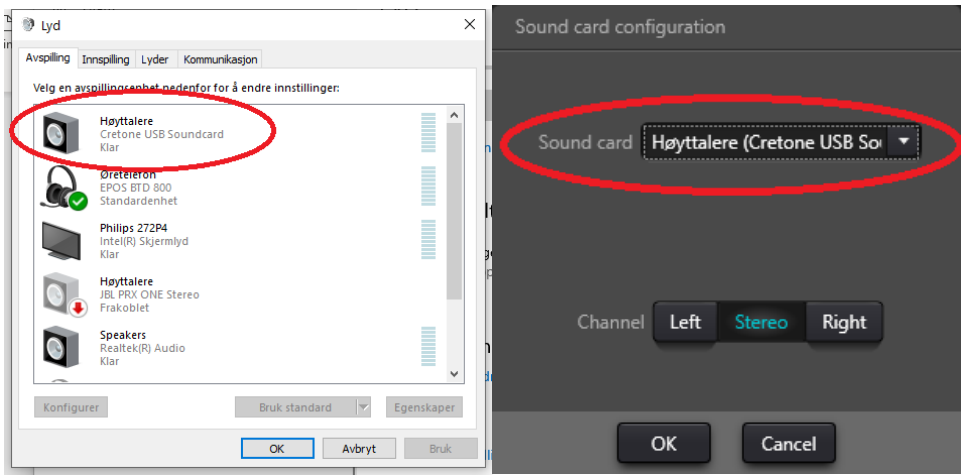

Soundcard Setting

USB cable with double ends of Type-A can be used to connect DSP processor and host computer. For the initial connection, "Found New Hardware" will pop up, and the driver will be installed automatically. After installation, USB soundcard will appear in computer soundcard list as shown below. Users may select USB soundcard in soundcard setting at software playlist.



Audio DSP with AEC, 4-in/4-out analog, 4-in/4-out Dante and USB

File playback from computer may be organized in a playlist. Add files to playlist with the + button next time. Add files to playlist with the  at the bottom and save it with the disk icon. Press  to clear the playlist and  to enter soundcard settings.

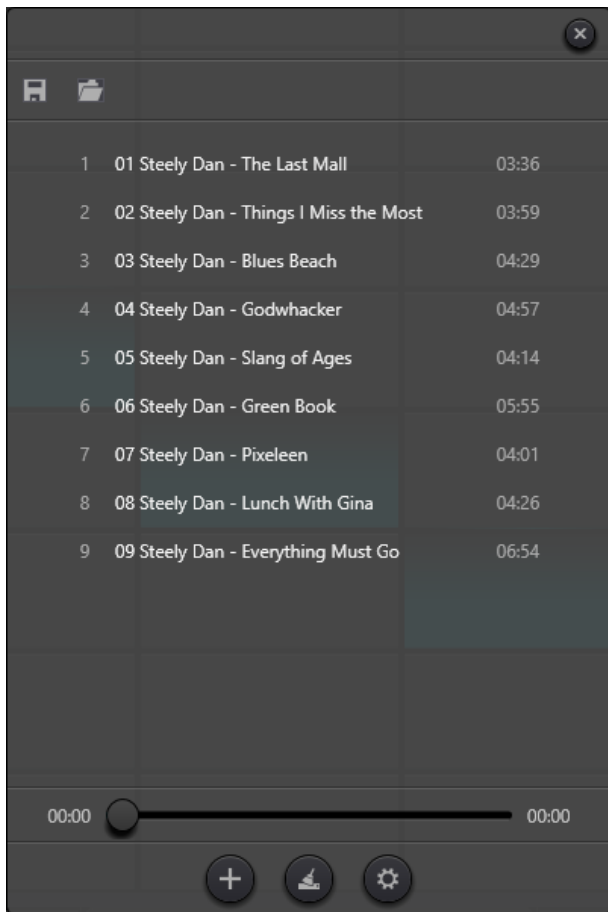

3.4 Setting Menu

3.4.1 File Menu

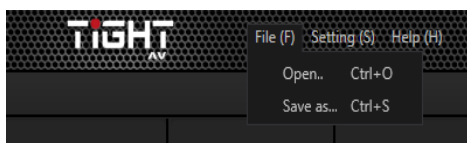

In offline mode, click the file dialog and open an existed default document with suffix *.tightavdsp. Use “Save as” to save configuration to local hard drive.

3.4.2 Device Setting

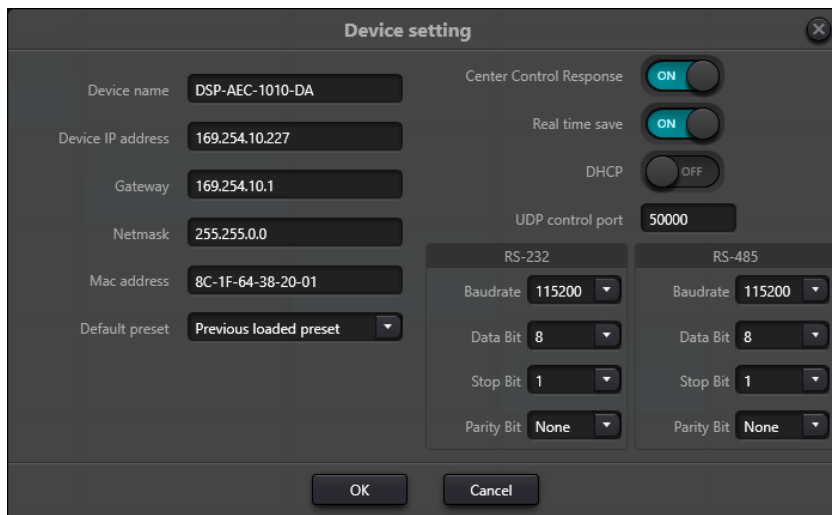

Information like device name, network address and serial port baud rate can be set in the device settings. Maximum length of the device name is 16 characters.

Default preset: Two start-up preset modes are available for selection. Select any of the 16 presets as start-up preset. Alternatively, selecting previously loaded preset will take the last used preset for the next start-up. For the unit to retain the current parameters after reboot the “Real time save” function must be on.

3.4.3 Group Setting

The group setting window have separate tabs for input and output groups. 4 groups can be set in each tab. A channel can only participate in one group. In the same group, the channel volume control and mute functions are linked. Other functions are not linked. For pairwise linking of all channel parameters, use the link button below the channel fader.

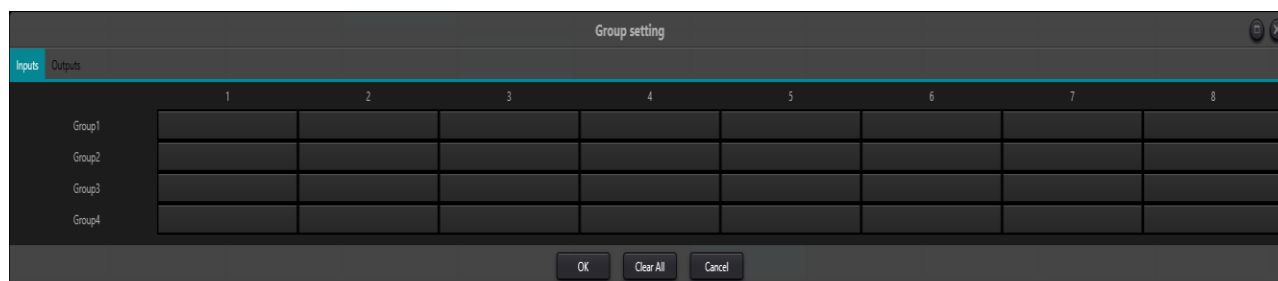

The relationship between groups and link: The channel participating in a group will not participate in LINK, which means group's priority is higher than LINK. The difference between groups and LINK is that groups can only control channel gain and mute, while LINK includes all parameters in the channel.

3.4.4 Panel Setting

Panel configuration page for button and OLED panels. Use network cables to connect multiple physical panels with DSP device via Ethernet.

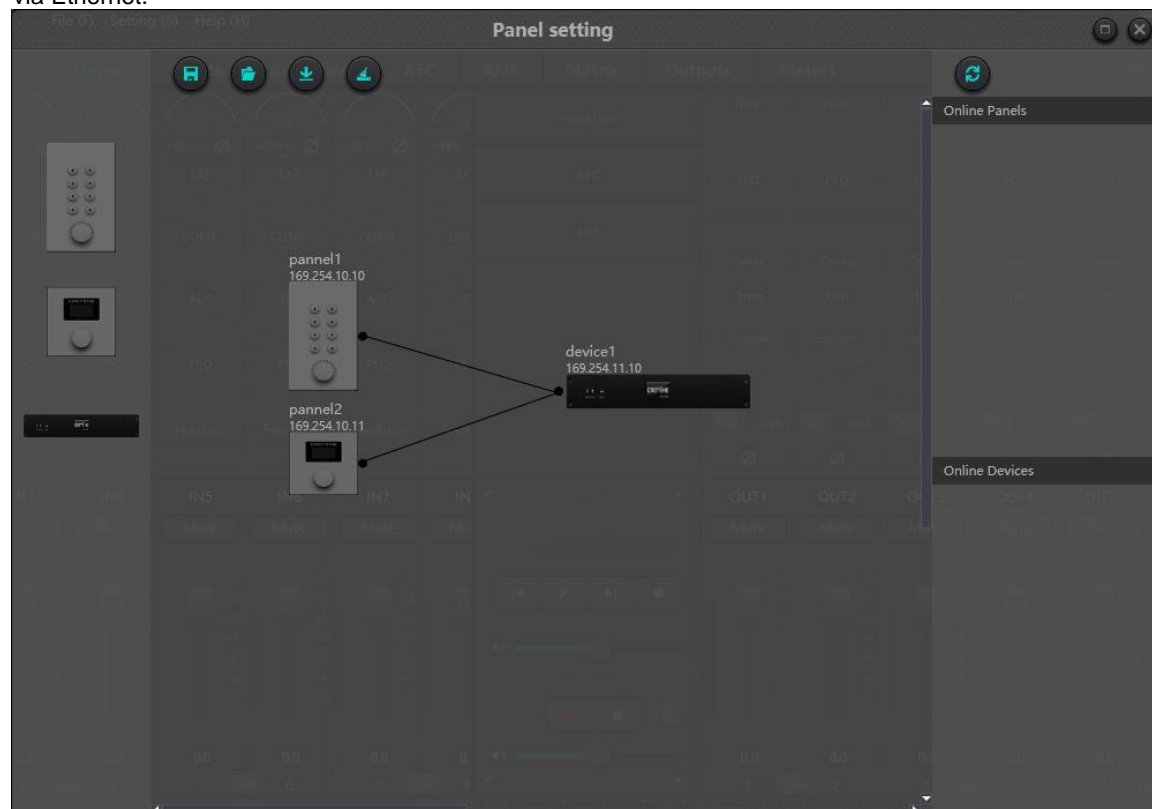

Offline device: Panels can be configured offline for later upload on-site.

Drag offline device from the sidebar to panel design area and double click to edit it.

Note the small circle on both panel and device. Click the circle and draw a line between the units to establish the connection between panel and the DSP device to be controlled.

Double click the panel in design area to enter panel configuration interface.

After finishing configuration, click the toolbar download icon  to download the panel configuration to hardware.

OLED panel:

The OLED panel consists of a 1.3" OLED screen and a knob. The panel functions are added in a list, and a single encoder is used for selecting the function and parameter adjustment.

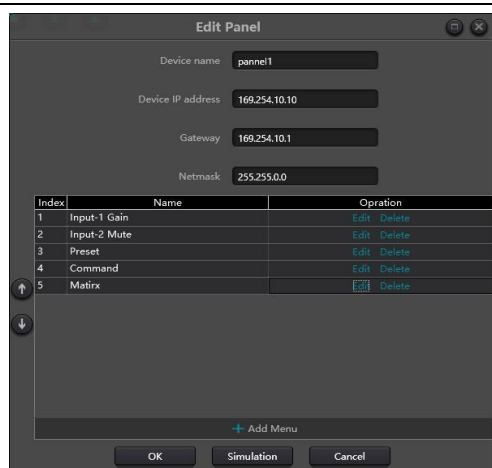

Click "add menu" to show menu selection box. Choose corresponding menu item and configure it. After finishing the setup, click toolbar download icon to download the configuration to panel hardware.

Panel menu navigation:

1. Display panel name and IP address on main interface and turn the knob left or right to select function.
2. Press the button on the knob, and the second row on menu interface starts to flash which indicates edit mode.
3. Turn the knob left or right to change value.
4. Press the button on the knob again to exit edit mode and go back to menu mode.

Key Panel:

There are 8 keys and one knob on the key panel. The knob is used to adjust gain and 8 keys can be used for different functions. There are four types of key functions, including volume adjustment, mute, preset and command. Drag an item in function area to appropriate key to program the key.

Similarly, after finishing all programming, users may use the emulation button to check whether the configuration is correct.

Instructions for panel operation indicators

1. Key indicator stays on, which indicates the key is configured with mute function.
2. Key indicator keeps flashing, which indicate the key is configured with gain function. The configured knob is used to adjust gain of the channel. 13 indicators around the knob indicate volume level.
3. A short flash when pressing the key indicates the key is configured with preset or command function.

Command function: The command data comes from central control command. Please refer to section 5.

3.4.5 Dante Setting

Use the Dante Controller software for routing and configuration of the Dante inputs and outputs.

The TiGHT AV DSP can interface with other Dante devices operating at 48kHz sampling frequency. Click the crosspoint between transmitting and receiving device to establish a subscription of the audio stream on the network.

Please refer to the Audinate Dante Controller user guide for more information

https://dev.audinate.com/GA/dante-controller/userguide/webhelp/content/front_page.htm

3.4.6 Help Menu

- (1) About
Display software version
- (2) Document
Display help file

(3) Central Control command

This is a tool used to find the string for use with a 3rd party controller.

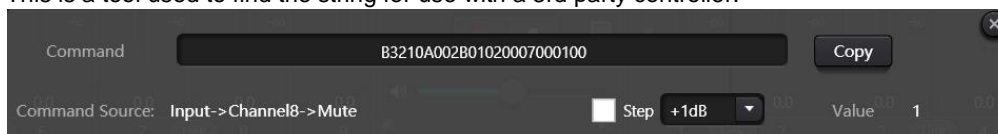

Open central control command window and click parameters to be controlled on interface, then the window will display the current command. Copy the command and use UDP or RS232 to send the command to the device.

- (4) Check for updates
Check for software update

4. Control

4.1 External Control Programmer

External control programmer supports UDP and RS232 and controls protocols covering all controls parameters of processor, including parameter controls, parameter acquisition and preset calling.

When UDP controls are used, the default port is 50000. Ports can be set in "Device Setting" via computer software.

When using RS232 controls are used, the default baud rate is 115200, digit bits is 8, and stop bit is 1, no parity bit. Similarly, they can be set in "Device Setting". **The interval between messages shall keep more than 100mS for RS232 sending.**

If central control needs reply, please turn on central control reply switch in "Device Setting".

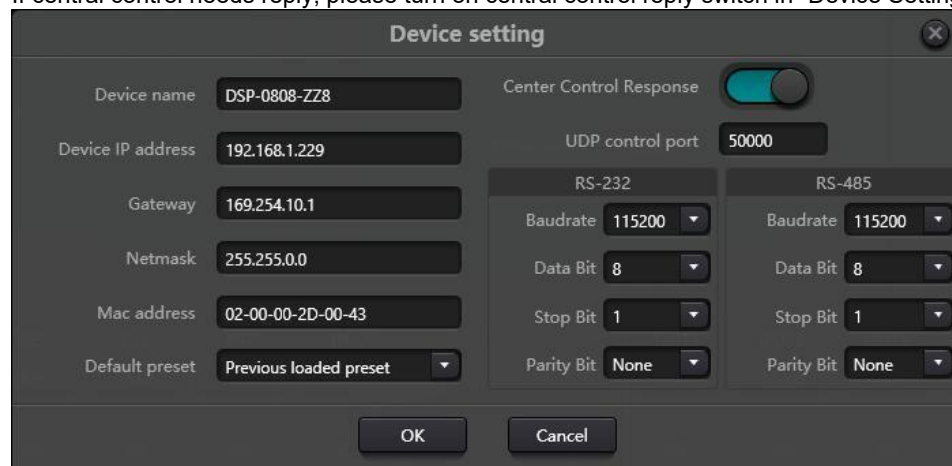

4.2 Control Protocol

Because of historical reasons, the latest control protocol adopts variable-length and is fully compatible with old fixed-length control protocols. In protocols, the fourth byte is used to distinguish versions. 0- indicates V1 version (previous versions) and 1- indicates V2 version (current protocol version).

The difference between V1 and V2 is V1 may control all processing module parameters, but one command can only control one parameter. If a parameter is needed to control continuous multiple channels, then V2 version shall be used. In other words, in condition that users need to press one key on key panel to trigger GPIO output high-/low-level of devices, or send a command via RS232/RS485, then V2 version will be the best choice.

Software coding rules (total 12 bytes)

byte1	byte2	byte3	byte4	byte5~132
0xb3		Length		Data
	Message Type		Version No.	

V1:

Information types (byte2): There are three information types including 0x21 (parameter controls), 0x22 (parameter acquisition) and 0x13 (scenario switch).

Length (byte3): invalid.

0x21 (parameter control):

At this point, Data byte5~12 is respectively

byte 5~6	byte 7~8	byte 9~10	byte 11~12
Module ID	Parameter Type	Parameter 1	Parameter 2

Please refer to Appendix A to get the distribution of **Module ID** (byte5~6).

Please refer to Appendix B for **Parameter types** (byte7~8).

When **Parameter 1** (byte9~10) has only one parameter, then only parameter 1 is valid, such as control compressor switch.

Parameter 2 (byte11~12) only valid when there are two parameters, such as control output channel 1 mute. Parameter value 1 shall be filled in input channel number from 0. Parameter value 2 shall be filled in 1 (mute).

Exception: Matrix routing has three parameters. The first one is input channel number, the second one is output channel number, and the third one is routing switch. At this point, byte9 of parameter value 1 shall be filled in input channel numbers, byte 10 shall be filled in output channel number, and parameter 2 shall be filled in routing switch.

0x22 (Parameter Acquisition):

Parameter acquisition rules are the same with parameter controls. The difference between them is values acquired shall be filled in parameter 1 and parameter 2.

0x13 (Scenario Switch):

Users only need to fill scenario numbers (0~15) in byte5 and 0 in byte6~12.

Note: Central control command of V1 version can acquire code through software menu bar of PC.

For customized development, please use this protocol rule.

V2:

Message types (byte2): There are three message types (byte2) including 0x21 (parameter controls), 0x22 (parameter acquisition), 0x13 (scenario switch), 0x74 (other controls) and 0x6e (Dante routing).

Length (byte3): Fill in corresponding data section length based on information type. The length can be longer when actual sending is carried out. Total data volume can be got through adding 4-byte header information to data length.

Audio DSP with AEC, 4-in/4-out analog, 4-in/4-out Dante and USB

1. Parameter Control (0x21)

At this point, the formats of data section are as follows.

byte5	byte6	byte7	byte8	byte9~72
Input/Output	Start Channel	End Channel	Parameter Type	Parameter Value

byte5: It indicate control input or output channel, 0x2- input channels and 0x1-output channels
 byte6-7: They indicate start and end channel numbers. Channel numbers start from 0.
 byte8: This kind of parameter is the same with V1 version. Please refer to Appendix B.

byte9-40: Fill in parameter values of start to end channels. It shall be filled in from the ninth byte. Each parameter value shall take two bytes.

2. Parameter Acquisition (0x22)

Data section format is the same with parameter controls. Parameter values may not be filled in. acquired parameters will be filled in this position.

3. Scenario Switch (0x13) byte5: Fill in scenario numbers (0-15). byte6-8: Fill in 0.

4. Other Controls (0x74)

Other controls include but not limited to GPIO, RS232, RS485 and central control replies. The protocol formats are as follows.

GPIO:

byte5	byte6	byte7	byte8	byte9	byte10	byte11	byte12
Control Type	Data Length	Reserved	Reserved	GPIO Direction	Start GPIO	End GPIO	Value

The controlling type for byte5 is 1.

The data length of byte6 is fixed as four bytes.

Byte9 GPIO direction, set input or output. Value 0 indicates input, and value 1 indicates output.

Byte10-11 start GPIO and end GPIO. DSP devices totally have eight GPIOs, which are indicated with number 0-7.

Byte12 is determined according to byte9GPIO direction. The field shall be filled in high (1) /low (0) level for output settings. The field is a return field to read GPIO level value on devices for input settings.

RS232/RS485:

byte5	byte6	byte7	byte8	byte9-132
Control Type	Data Length	Reserved	Reserved	Data

Byte5 is 2 when controlling type RS232, and 3 for RS485.

The data length of byte6 refers to data length that shall be sent via RS232/485 currently.

Byte9-132 shall be filled in data sent by RS232/485.

Audio DSP with AEC, 4-in/4-out analog, 4-in/4-out Dante and USB

Central control replies:

byte5	byte6	byte7	byte8	byte9
Control Type	Data Length	Reserved	Reserved	Reply Switch

Byte5 controlling type is 4.

The data length of byte6 is 1.

When byte9 is 1, it means turning on central control replies switch; and 0 means turning off replies.

4.3 Serial Port-to-UDP (RS232 To UDP)

DSP devices support RS232 translating into UDP. The protocol formats are as follows.

4bytes prefix	4bytes	2bytes	1byte	1byte	128bytes
UDP:	IP Address	Port	Data Length	Reserved	Data

After receiving the protocol format data packet, RS232 send data in the protocol to the appointed IP addresses and devices at ports.

For example, when sending data "HELLO DSP to device port 50000 of device "192.168.10.22", the protocol commands are as follows.

4 bytes prefix	4 bytes	2 bytes	1 byte	1 byte	128 bytes
0x3a504455 (':PDU')	0x1610A8C0	0xC350	0x09	0x00	"HELLO DSP"

Application scenario: The function can be applied in scenarios when many central control hosts have no network port. As shown in the figure, central control hosts translate network commands through serial ports to control any network device.

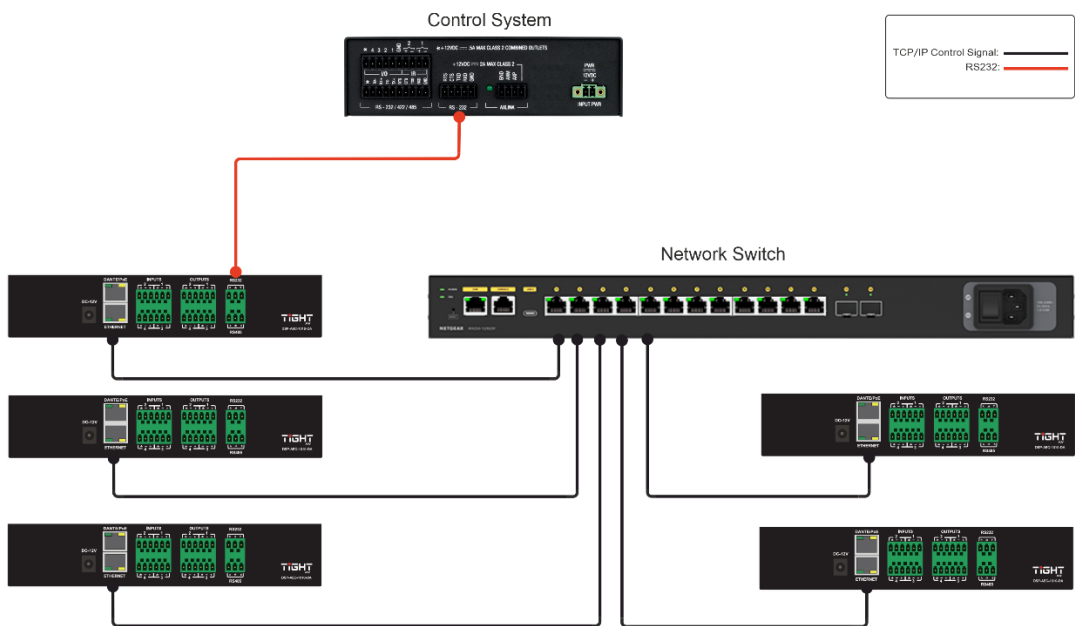

Audio DSP with AEC, 4-in/4-out analog, 4-in/4-out Dante and USB

Appendix A: Module ID Distribution

Module Name	ID	Module Name	ID
Input source	299	Output Channel 1-32 High & Low Pass	167~198
Input Channel 1-32 Expander	1~32	Output Channel 1-32 Equalizer	199~230
Input Channel 1-32 Compressor	33~64	Output Channel 1-32 Delayer	231~262
Input Channel 1-32 Auto Gain	65~95	Output Channel 1-32 Limiter	263~294
Input Channel 1-32 Equalizer	97~128		
Input Channel 1-32 Feedback Inhibition	129~160		
AutoMixer	161	Echo Canceller	162
Echo Cancellation	163	Noise Suppressor	164
Noise Suppression	165		
Mixer	166		
Output	295		
System Control	296		

Appendix B: Module Parameter Types (1)

Module Name	Parameter Type	Description	Module Name	Parameter Type	Description
Input Source	0x1	Gain	Output	0x10	Gain Compensation
	0x2	Mute		0x11	Link
	0x3	Sensitivity		0x12	Channel Level
	0x4	Phantom Power Switch		0x1	Gain
	0x5	Signal Generator Type		0x2	Mute
	0x6	Signal Generator Frequency		0x3	Channel Name
	0x7	Sine Wave Gain Size		0x4	Invert
	0x8	Channel Name		0x5	Sensitivity
	0x9	Invert		0x6	Gain Compensation
	0x10	Gain Compensation		0x7	Link
	0x11	Link		0x8	Channel Level
	0x12	Channel Level	Expander	0x1	Switch

Audio DSP with AEC, 4-in/4-out analog, 4-in/4-out Dante and USB

Delayer	0x1	Bypass Switch		0x2	Threshold
	0x2	Millisecond		0x3	Ratio
	0x3	Microsecond		0x4	Setup Time
Equalizer	0x1	Total Equalizer Switch		0x5	Release Time
	0x2	Child Segment Switch	Compressor	0x1	Compressor Switch
	0x3	Frequency		0x2	Compressor Threshold
	0x4	Gain		0x3	Compressor Ratio
	0x5	Q Value		0x4	Setup Time
	0x6	Type		0x5	Recovery Time
				0x6	Gain Compensation

Appendix B: Module Parameter Types (2)

Module Name	Parameter Type	Description	Module Name	Parameter Type	Description
Mixer	0x1	Mixer Switch	Feedback Inhibition	0x1	Switch
	0x2	Mixer Gain		0x2	Feedback Point Frequency
High & Low Pass	0x1	High Pass Switch		0x3	Feedback Point Gain
	0x2	High Pass Type		0x6	Preset
	0x3	High Pass Slope		0x7	Clear
	0x4	High Pass Frequency		0x8	Panic Threshold
	0x5	High Pass Gain		0x9	Feedback
	0x11	Low Pass Switch	Auto Gain	0x1	Switch
	0x12	Low Pass Type		0x2	Threshold
	0x13	Low Pass Slope		0x3	Target Threshold
	0x14	Low Pass Frequency		0x4	Ratio
	0x15	Low Pass Gain		0x5	Setup Time
Auto Mix	0x1	Total Mute		0x6	Release Time
	0x2	Total Gain	Echo Cancellation	0x1	Echo Cancellation Switch
	0x3	Slope		0x2	Echo Cancellation Mode

Audio DSP with AEC, 4-in/4-out analog, 4-in/4-out Dante and USB

	0x4	Response Time	Noise Suppression	0x1	Noise Suppression Switch
	0x5	Channel Auto Switch		0x2	Noise Suppression Mode
	0x6	Channel Mute	System Control	0x1	System Mute
	0x7	Channel Gain		0x2	System Gain
	0x8	Priority			
	0x9	Auto Mix Switch			

5. Customer Service

The return of a product to our Customer Service implies the full agreement of the terms and conditions hereinafter. These terms and conditions may be changed without prior notice.

1) Warranty

We provide limited warranty for the product within **five years** counting from date of purchase (The purchase invoice shall prevail).

2) Scope

These terms and conditions of Customer Service apply to the customer service provided for the products or any other items sold by authorized distributor only.

3) Warranty Exclusion

- Warranty expiration.
- Factory applied serial number has been altered or removed from the product.
- Damage, deterioration or malfunction caused by:
 - ✓ Normal wear and tear.
 - ✓ Use of supplies or parts not meeting our specifications.
 - ✓ No certificate or invoice as the proof of warranty.
 - ✓ The product model showed on the warranty card does not match with the model of the product for repairing or had been altered.
 - ✓ Damage caused by force majeure.
 - ✓ Servicing not authorized by distributor.
 - ✓ Any other causes which don't relate to a product defect.
- Shipping fees, installation or labor charges for installation or setup of the product.

4) Documentation:

Customer Service will accept defective product(s) in the scope of warranty coverage at the sole condition that the malfunction has been clearly defined, and upon reception of the documents or copy of invoice, indicating the date of purchase, the type of product, the serial number, and the name of distributor.

Remarks: Please contact your local distributor for further assistance or solutions.