

# OmniStream™ Single-Channel / Dual-Channel Networked AV Encoder



## Version Information

Version	Release Date	Notes
1	Apr 2017	Initial release
2	Jun 2017	New enclosure, documentation updates: AMS interface; front-panel buttons, decoder set tab
3	Nov 2017	Added EDID management, text insertion, state / logo insertion, encoder grouping
4	May 2018	Updated to reflect AMS 2.0
5	Jun 2018	Includes updates to 1.2.1 firmware; AMS updates
6	Jan 2019	1.2.2 firmware; encoder daisy-chaining
7	Mar 2019	1.2.3 firmware; supports ID button for AT-OMNI-111 Rev. J hardware; refer to 1.2.3 release note for a list of all features / fixes
8	Aug 2019	Documentation updated to support AMS 2.4.0
9	Sep 2019	Documentation updated to support OmniStream 1.2.5; various bug fixes and added Virtual Reality EDID resolution. Refer to <a href="#">EDID Management (page 58)</a> for more information.
10	Feb 2020	Added web server documentation reflecting changes to 1.2.6 firmware. Refer to the release notes for a complete listing features and bug fixes. - Audio tone generator option added under Session > Audio > Source. Refer to the <a href="#">Session page (page 111)</a> . - LLDP menu item added. Refer to the <a href="#">LLDP page (page 125)</a> .
11	Jan 2021	<b>Firmware 1.2.7</b> - FPGA information now available under the <b>System Information</b> page. Refer to <a href="#">System information page (page 99)</a> for more information. - NTP server set to pool.ntp.org, by default; change under the <b>System Information</b> page. Refer to <a href="#">System information page (page 99)</a> for more information. - Custom SAP multicast address can now be configured under the <b>SAP</b> page. Refer to <a href="#">SAP page (page 102)</a> for more information. - Telnet session can now be disabled under the <b>Network</b> page. Refer to <a href="#">Network page (page 121)</a> for more information.

## Welcome to Atlona!

---

Thank you for purchasing this Atlona product. We hope you enjoy it and will take a extra few moments to register your new purchase.

Registration only takes a few minutes and protects this product against theft or loss. In addition, you will receive notifications of product updates and firmware. Atlona product registration is voluntary and failure to register will not affect the product warranty.

To register your product, go to <http://www.atlona.com/registration>

## Sales, Marketing, and Customer Support

---

### Main Office

Atlona Incorporated  
70 Daggett Drive  
San Jose, CA 95134  
United States

Office: +1.877.536.3976 (US Toll-free)  
Office: +1.408.962.0515 (US/International)

Sales and Customer Service Hours  
Monday - Friday: 6:00 a.m. - 4:30 p.m. (PST)

<http://www.atlona.com/>

### International Headquarters

Atlona International AG  
Ringstrasse 15a  
8600 Dübendorf  
Switzerland

Office: +41 43 508 4321

Sales and Customer Service Hours  
Monday - Friday: 09:00 - 17:00 (UTC +1)

## Operating Notes

---

- The Atlona Management System (AMS) is a free downloadable application from Atlona that provides network configuration assistance for this product. This application is available only for the Windows® Operating System and can be downloaded from the Atlona web site.



**IMPORTANT:** Visit <http://www.atlona.com/product/AT-OMNI-111> and <http://www.atlona.com/product/AT-OMNI-112> for the latest firmware updates and User Manual.



**NOTE:** Scaling and deinterlacing is not supported at 1080i.

# Atlona, Inc. (“Atlona”) Limited Product Warranty

---

## Coverage

Atlona warrants its products will substantially perform to their published specifications and will be free from defects in materials and workmanship under normal use, conditions and service.

Under its Limited Product Warranty, Atlona, at its sole discretion, will either:

- repair or facilitate the repair of defective products within a reasonable period of time, restore products to their proper operating condition and return defective products free of any charge for necessary parts, labor and shipping.

OR

- replace and return, free of charge, any defective products with direct replacement or with similar products deemed by Atlona to perform substantially the same function as the original products.

OR

- refund the pro-rated value based on the remaining term of the warranty period, not to exceed MSRP, in cases where products are beyond repair and/or no direct or substantially similar replacement products exist.

Repair, replacement or refund of Atlona products is the purchaser’s exclusive remedy and Atlona liability does not extend to any other damages, incidental, consequential or otherwise.

This Limited Product Warranty extends to the original end-user purchaser of Atlona products and is non-transferrable to any subsequent purchaser(s) or owner(s) of these products.

## Coverage Periods

Atlona Limited Product Warranty Period begins on the date of purchase by the end-purchaser. The date contained on the end-purchaser’s sales or delivery receipt is the proof purchase date.

### Limited Product Warranty Terms – New Products

- 10 years from proof of purchase date for hardware/electronics products purchased on or after June 1, 2013.
- 3 years from proof of purchase date for hardware/electronics products purchased before June 1, 2013.
- Lifetime Limited Product Warranty for all cable products.

### Limited Product Warranty Terms – Refurbished (B-Stock) Products and Discontinued Products

- 3 years from proof of purchase date for all Refurbished (B-Stock) and Discontinued hardware and electronic products purchased on or after June 1, 2013.

## Remedy

Atlona recommends that end-purchasers contact their authorized Atlona dealer or reseller from whom they purchased their products. Atlona can also be contacted directly. Visit [atlona.com](http://atlona.com) for Atlona’s contact information and hours of operation. Atlona requires that a dated sales or delivery receipt from an authorized dealer, reseller or end-purchaser is provided before Atlona extends its warranty services. Additionally, a return merchandise authorization (RMA) and/or case number, is required to be obtained from Atlona in advance of returns.

Atlona requires that products returned are properly packed, preferably in the original carton, for shipping. Cartons not bearing a return authorization or case number will be refused. Atlona, at its sole discretion, reserves the right to reject any products received without advanced authorization. Authorizations can be requested by calling 1-877-536-3976 (US toll free) or 1-408- 962-0515 (US/international) or via Atlona’s website at [atlona.com](http://atlona.com).

## Exclusions

This Limited Product Warranty excludes:

- Damage, deterioration or malfunction caused by any alteration, modification, improper use, neglect, improper packaging or shipping (such claims must be presented to the carrier), lightning, power surges, or other acts of nature.

## Atlona, Inc. (“Atlona”) Limited Product Warranty

---

- Damage, deterioration or malfunction resulting from the installation or removal of this product from any installation, any unauthorized tampering with this product, any repairs attempted by anyone unauthorized by Atlona to make such repairs, or any other cause which does not relate directly to a defect in materials and/or workmanship of this product.
- Equipment enclosures, cables, power supplies, batteries, LCD displays, and any accessories used in conjunction with the product(s).
- Products purchased from unauthorized distributors, dealers, resellers, auction websites and similar unauthorized channels of distribution.

### Disclaimers

This Limited Product Warranty does not imply that the electronic components contained within Atlona’s products will not become obsolete nor does it imply Atlona products or their electronic components will remain compatible with any other current product, technology or any future products or technologies in which Atlona’s products may be used in conjunction with. Atlona, at its sole discretion, reserves the right not to extend its warranty offering in instances arising outside its normal course of business including, but not limited to, damage inflicted to its products from acts of god.

### Limitation on Liability

The maximum liability of Atlona under this limited product warranty shall not exceed the original Atlona MSRP for its products. To the maximum extent permitted by law, Atlona is not responsible for the direct, special, incidental or consequential damages resulting from any breach of warranty or condition, or under any other legal theory. Some countries, districts or states do not allow the exclusion or limitation of relief, special, incidental, consequential or indirect damages, or the limitation of liability to specified amounts, so the above limitations or exclusions may not apply to you.

### Exclusive Remedy

To the maximum extent permitted by law, this limited product warranty and the remedies set forth above are exclusive and in lieu of all other warranties, remedies and conditions, whether oral or written, express or implied. To the maximum extent permitted by law, Atlona specifically disclaims all implied warranties, including, without limitation, warranties of merchantability and fitness for a particular purpose. If Atlona cannot lawfully disclaim or exclude implied warranties under applicable law, then all implied warranties covering its products including warranties of merchantability and fitness for a particular purpose, shall provide to its products under applicable law. If any product to which this limited warranty applies is a “Consumer Product” under the Magnuson-Moss Warranty Act (15 U.S.C.A. §2301, ET SEQ.) or other applicable law, the foregoing disclaimer of implied warranties shall not apply, and all implied warranties on its products, including warranties of merchantability and fitness for the particular purpose, shall apply as provided under applicable law.

### Other Conditions

Atlona’s Limited Product Warranty offering gives legal rights, and other rights may apply and vary from country to country or state to state. This limited warranty is void if (i) the label bearing the serial number of products have been removed or defaced, (ii) products are not purchased from an authorized Atlona dealer or reseller. A comprehensive list of Atlona’s authorized distributors, dealers and resellers can be found at [www.atlona.com](http://www.atlona.com).

## Safety and Certification

**CAUTION**  
 RISK OF ELECTRIC SHOCK  
 DO NOT OPEN

CAUTION: TO REDUCE THE RISK OF  
 ELECTRIC SHOCK  
 DO NOT OPEN ENCLOSURE OR EXPOSE  
 TO RAIN OR MOISTURE.  
 NO USER-SERVICEABLE PARTS  
 INSIDE REFER SERVICING TO  
 QUALIFIED SERVICE PERSONNEL.



The exclamation point within an equilateral triangle is intended to alert the user to the presence of important operating and maintenance instructions in the literature accompanying the product.



The information bubble is intended to alert the user to helpful or optional operational instructions in the literature accompanying the product.

1. Read these instructions.
2. Keep these instructions.
3. Heed all warnings.
4. Follow all instructions.
5. Do not use this product near water.
6. Clean only with a dry cloth.
7. Do not block any ventilation openings. Install in accordance with the manufacturer's instructions.
8. Do not install or place this product near any heat sources such as radiators, heat registers, stoves, or other apparatus (including amplifiers) that produce heat.
9. Do not defeat the safety purpose of a polarized or grounding-type plug. A polarized plug has two blades with one wider than the other. A grounding type plug has two blades and a third grounding prong. The wide blade or the third prong are provided for your safety. If the provided plug does not fit into your outlet, consult an electrician for replacement of the obsolete outlet.
10. Protect the power cord from being walked on or pinched particularly at plugs, convenience receptacles, and the point where they exit from the product.
11. Only use attachments/accessories specified by Atlona.
12. To reduce the risk of electric shock and/or damage to this product, never handle or touch this unit or power cord if your hands are wet or damp. Do not expose this product to rain or moisture.
13. Unplug this product during lightning storms or when unused for long periods of time.
14. Refer all servicing to qualified service personnel. Servicing is required when the product has been damaged in any way, such as power-supply cord or plug is damaged, liquid has been spilled or objects have fallen into the product, the product has been exposed to rain or moisture, does not operate normally, or has been dropped.



## FCC Statement

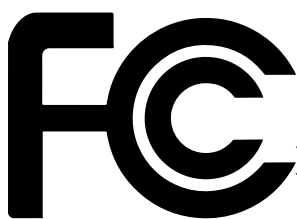

FCC Compliance and Advisory Statement: This hardware device complies with Part 15 of the FCC rules. Operation is subject to the following two conditions: 1) this device may not cause harmful interference, and 2) this device must accept any interference received including interference that may cause undesired operation. This equipment has been tested and found to comply with the limits for a Class A digital device, pursuant to Part 15 of the FCC Rules.

These limits are designed to provide reasonable protection against harmful interference in a commercial installation. This equipment generates, uses, and can radiate radio frequency energy and, if not installed or used in accordance with the instructions, may cause harmful interference to radio communications. However there is no guarantee that interference will not occur in a particular installation. If this equipment does cause harmful interference to radio or television reception, which can be determined by turning the equipment off and on, the user is encouraged to try to correct the interference by one or more of the following measures: 1) reorient or relocate the receiving antenna; 2) increase the separation between the equipment and the receiver; 3) connect the equipment to an outlet on a circuit different from that to which the receiver is connected; 4) consult the dealer or an experienced radio/TV technician for help. Any changes or modifications not expressly approved by the party responsible for compliance could void the user's authority to operate the equipment. Where shielded interface cables have been provided with the product or specified additional components or accessories elsewhere defined to be used with the installation of the product, they must be used in order to ensure compliance with FCC regulations.



The terms HDMI, HDMI High-Definition Multimedia Interface, and the HDMI Logo are trademarks or registered trademarks of HDMI licensing Administrator, Inc.

# Table of Contents

---

<b>Introduction</b>	<b>9</b>
<b>Features</b>	<b>9</b>
<b>Package Contents</b>	<b>9</b>
<b>Panel Description</b>	<b>10</b>
AT-OMNI-111	10
AT-OMNI-112	11
<b>Installation</b>	<b>12</b>
External Power (Optional)	12
RS-232 Connections	12
IR Connections	13
Connection Instructions	14
Connection Diagram	15
<b>Configuration</b>	<b>16</b>
Accessing Encoders in AMS	16
Configuring a Static IP Address	20
Input Selection	21
Input Selection	21
Verifying the Input	22
Session Configuration	23
<b>Basic Operation</b>	<b>24</b>
LED Indicators	24
Rebooting OmniStream	25
Selecting the Input	25
Powering the Display	25
Adjusting Volume	26
Single-output Mode	26
Dual-output Mode	26
ID Button	27
Broadcast Messaging	27
Reset to Factory-Default Settings	27
Input Switching Configuration	28
Unicast Mode	29
Multicast Mode	31
<b>IR Control</b>	<b>33</b>
Controlling the Display using the Display's IR Remote	33
Required Equipment	34
Connecting the IR Receiver to the Encoder	34
Connecting the IR Emitter to the Decoder	35
Identifying the Encoder using AMS	36
Configuring the Encoder Serial Port	37
Configuring the Encoder Session	38
Configuring the Decoder Serial Port	40
Testing IR Functionality	43
Controlling the Display using a Control System	44
Using the Virtual Matrix	45
<b>Advanced Operation</b>	<b>48</b>
Control Using RS-232	48
RS-232 Pass-through	48
Using TCP Proxy	48
Using the Virtual Matrix	49
802.1X Authentication	54
AES67 Audio	57
EDID Management	58
Selecting an EDID Preset	58

Using a Custom EDID	58
Copying an EDID from the Display	60
Encoder Grouping	63
Daisy-Chaining Encoders	65
Scrambling	67
Standard Method	67
Using the Virtual Matrix	68
Setting the Video Mode	69
Slate / Logo Insertion	70
Adding Slates / Logos	70
Deleting Slates / Logos	73
Text Insertion	74
<b>The AMS Interface</b>	<b>75</b>
Device Info page	75
Input page	78
Serial page	81
Session page	83
Network page	87
Other page	89
Logo	89
Text	90
PTP	91
The Virtual Matrix	93
Layout and Operation	94
<b>Web Server</b>	<b>96</b>
Accessing the Web Server	96
Getting the IP Address	96
Logging In	97
System information page	99
SAP page	102
Input page	103
EDID page	106
Encoding page	107
Serial page	109
Session page	111
Logo page	117
Text page	119
Network page	121
PTP page	123
LLDP page	125
Configuration page	126
Users page	127
License page	128
Upgrade page	129
<b>Appendix</b>	<b>130</b>
Updating the Firmware using Velocity™/AMS	130
Updating the Firmware using the Web Server	133
FEC Details	134
Matrix Size, Overhead, and Latency	134
FEC and Video Bitrate	134
FEC, Latency, and Lip Sync	135
Mounting Instructions	136
Rack Tray for OmniStream	137
Specifications	138
Single-Channel Encoder	138
Dual-Channel Encoder	141



## Introduction

---

The Atlona OmniStream™ 111 (AT-OMNI-111) is a networked AV encoder for one HDMI source up to 4K/UHD, plus embedded audio and RS-232 control. The Atlona OmniStream™ 112 (AT-OMNI-112) adds a second channel of encoding for two HDMI sources up to 4K/UHD and RS-232 control and can deliver duplicate AV streams to two networks for full system redundancy in mission-critical applications. OmniStream features SMPTE VC-2 compression for critical-quality video applications, with extremely low, sub-frame latency from encode to decode. It also includes selectable AES-128 encryption and SMPTE 2022-5 Forward Error Correction (FEC) for robust AV distribution spanning multiple networks. This encoder is housed in a half-rack width enclosure. Both OmniStream encoders are housed in compact enclosures that easily fit into a half RU space. They can be powered over the network through Power over Ethernet (PoE) or optionally from local AC power.

OmniStream was engineered from the ground up at Atlona to deliver the performance and dependability of traditional AV distribution, with the virtually unlimited scalability and cost efficiency of integrating over data networks. It addresses the many challenges AV and IT integrators encounter with implementing networked AV systems, while delivering immediate and long-term ROI to end users in enterprises and other organizations

## Features

---

### OmniStream Single-Channel Encoder

- Single-channel AV encoder for HDMI up to 4K/UHD
- SMPTE VC-2 compression
- RS-232 control
- Selectable AES-128 encryption
- SMPTE 2022-5 FEC
- Powered using PoE or optional external 48V DC power supply

### OmniStream Dual-Channel Encoder

- Dual-channel AV encoder for HDMI up to 4K/UHD
- Secondary channel provides redundancy for mission-critical applications
- SMPTE VC-2 compression
- RS-232 control
- Selectable AES-128 encryption
- SMPTE 2022-5 (FEC)
- Powered using PoE or optional external 48V DC power supply

## Package Contents

---

### OmniStream Single-Channel Encoder

- 1 x AT-OMNI-111
- 1 x Phoenix terminal block, 6-pin (push spring)
- 1 x Wall/table mounting brackets
- 4 x Rubber feet
- 1 x Installation Guide

### OmniStream Dual-Channel Encoder

- 1 x AT-OMNI-112
- 1 x Phoenix terminal block, 6-pin (push spring)
- 1 x Wall/table mounting brackets
- 4 x Rubber feet
- 1 x Installation Guide

# Panel Description

## AT-OMNI-111



Front

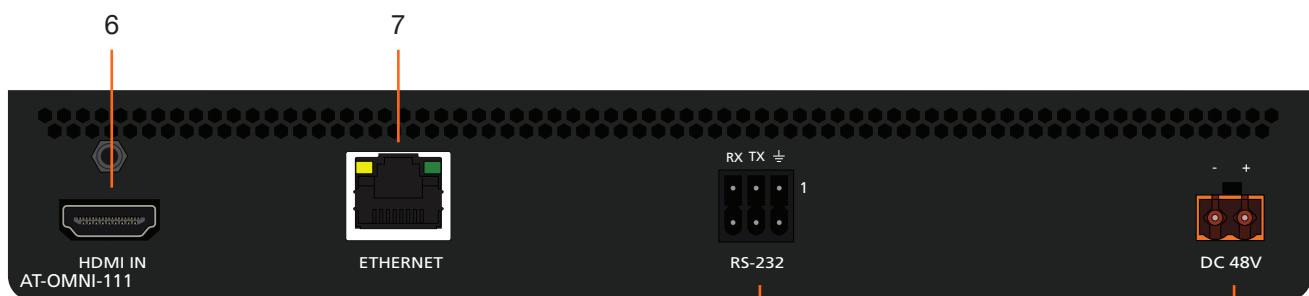

Rear

- |  |  |
|--|--|
| <p><b>1 PWR</b><br/>This LED indicator is green when the unit is powered and fully booted.</p> <p><b>2 HDMI</b><br/>This LED indicator is green when the link between source and encoder is good.</p> <p><b>3 LINK</b><br/>This LED indicator will be green when the link integrity between the between the encoder and the network switch is good.</p> <p><b>4 ID</b><br/>This button provides two functions:<br/>(1) Press and release this button to send a broadcast network notification to any devices that may be listening (AMS).<br/>(2) Press and hold this button for 30 seconds to perform a factory-reset of the unit. Refer to <a href="#">ID Button (page 27)</a> for more information.</p> <p><b>5 REBOOT</b><br/>Use a small, pointed object to press this recessed button and reboot the unit.</p> | <p><b>6 HDMI</b><br/>Connect an HDMI cable from this port to a UHD/ HD source.</p> <p><b>7 ETHERNET</b><br/>Connect an Ethernet cable from this port to the Local Area Network (LAN).</p> <p><b>8 RS-232</b><br/>Use the included Euroblock push-spring terminal block to connect an RS-232 controller or automation system. Refer to <a href="#">RS-232 Connections (page 12)</a> for more information.</p> <p><b>9 DC 48V</b><br/>Connect the optional 48V DC power supply to this power receptacle. This power supply is available, separately, and is required when connecting the encoder to non-PoE compatible switch.</p> |
|--|--|

## AT-OMNI-112

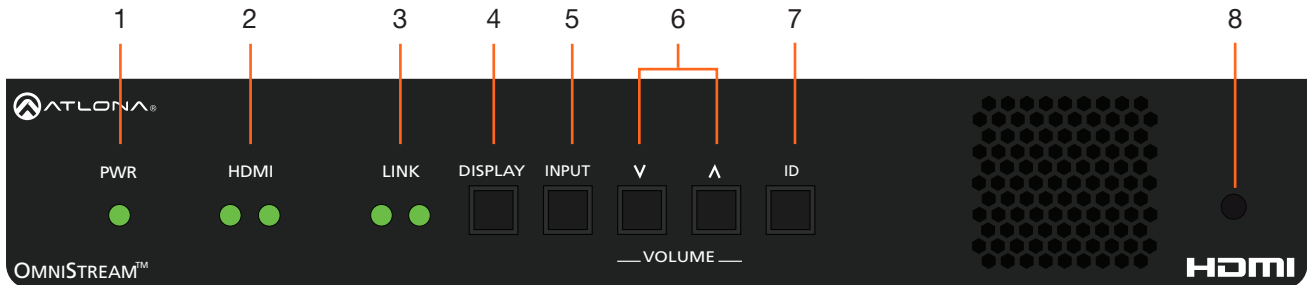

Front

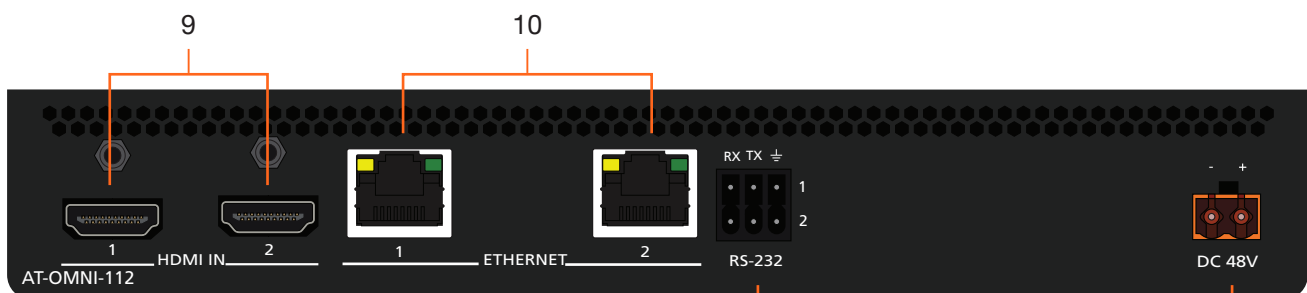

Rear

- |   |   |
|---|---|
| <p><b>1 PWR</b><br/>This LED indicator is green when the unit is powered and booted.</p> <p><b>2 HDMI 1 / HDMI 2</b><br/>These LED indicators are green when the link between source and encoder is good.</p> <p><b>3 LINK 1 / LINK 2</b><br/>These LED indicators will be green when the link integrity between the between the encoder and the network switch is good.</p> <p><b>4 DISPLAY</b><br/>Press this button to toggle the power state of the desired display. Refer to <a href="#">Powering the Display (page 25)</a> for more information.</p> <p><b>5 INPUT</b><br/>Press this button to switch between HDMI 1 and HDMI 2 inputs. Refer to <a href="#">Selecting the Input (page 25)</a> for more information.</p> <p><b>6 VOLUME</b><br/>Press these buttons to adjust the output volume of the desired display. Refer to <a href="#">Adjusting Volume (page 26)</a> for more information.</p> <p><b>7 ID</b><br/>This button provides two functions:<br/>(1) Press and release this button to send a</p> | <p>broadcast network notification to any devices that may be listening (AMS). (2) Press and hold this button for 30 seconds to perform a factory-reset of the unit. Refer to <a href="#">ID Button (page 27)</a> for more information.</p> <p><b>8 REBOOT</b><br/>Press this button, using a small, pointed object to reboot the unit.</p> <p><b>9 HDMI IN 1 / HDMI IN 2</b><br/>Connect HDMI cables from these ports to a UHD/HD source.</p> <p><b>10 ETHERNET 1 / ETHERNET 2</b><br/>Connect Ethernet cables from these ports to the Local Area Network (LAN).</p> <p><b>RS-232 1 / RS-232 2</b><br/>Use the included Euroblock push-spring terminal block to connect up to two RS-232 devices to this port. Refer to <a href="#">RS-232 Connections (page 12)</a> for more information.</p> <p><b>11 DC 48V</b><br/>Connect the optional 48V DC power supply to this power receptacle. This power supply is available, separately, and is required when connecting the encoder to non-PoE compatible switch.</p> |
|---|---|

# Installation

## External Power (Optional)

OmniStream encoders are powered by PoE (Power over Ethernet), when connected to a PoE-capable switch. If a PoE-switch is not used, then the optional 48 V power supply (Atlona part no. AT-PS-48083-C) can be purchased, separately. Insert the positive and negative leads, from the power supply, into the terminals of the 2-pin captive screw connector block, as shown. The orange 2-pin captive screw connector block is included with the OmniStream power supply package.

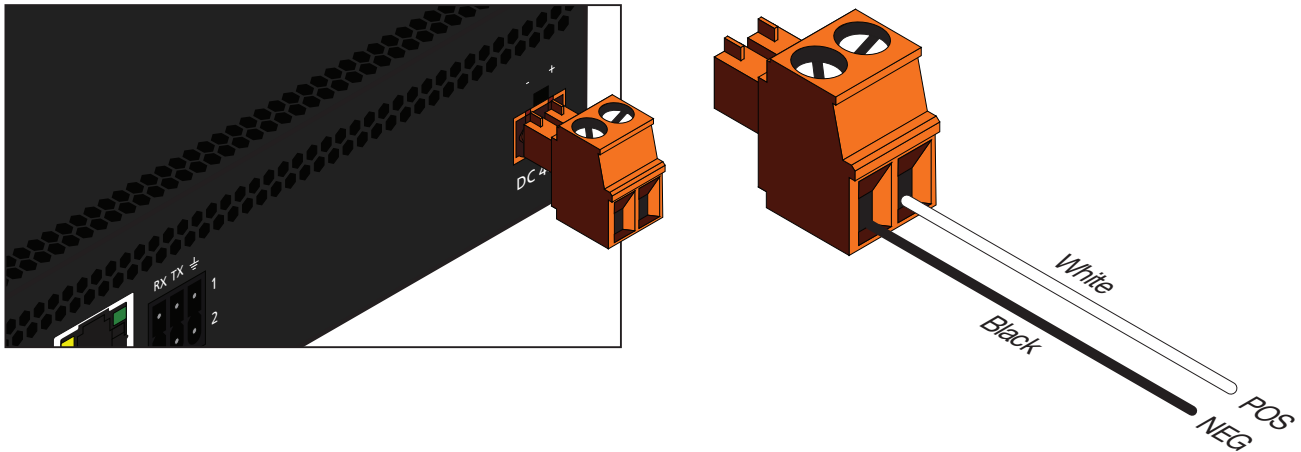

## RS-232 Connections

Both the AT-OMNI-111 and AT-OMNI-112 provide RS-232 over IP, allowing communication between an automation system and an RS-232 device. This step is optional.

1. Use wire strippers to remove a portion of the cable jacket.
2. Remove at least 3/16" (5 mm) from the insulation of the RX, TX, and GND wires.
3. Insert the TX, RX, and GND wires into correct terminal on the included Phoenix block. If using non-tinned stranded wire, press the orange tab, above the terminal, while inserting the exposed wire. Repeat this step for the TX, RX, and GND connections.

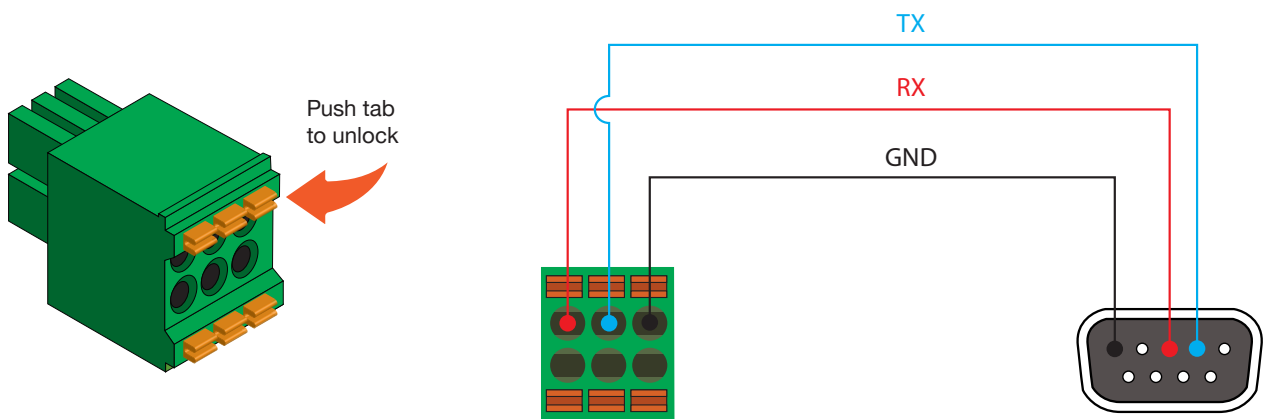

**NOTE:** Typical DB9 connectors use pin 2 for TX, pin 3 for RX, and pin 5 for ground. On some devices, pins 2 and 3 are reversed.

## IR Connections

The same port that provides RS-232 connections also supports bidirectional IR pass-through, allowing a device to be controlled from either the headend or the decoder endpoint. This step is optional. IR control is only supported on **RS-232 2** port (bottom set of connectors). Refer to **IR Control (page 33)** for configuration details.

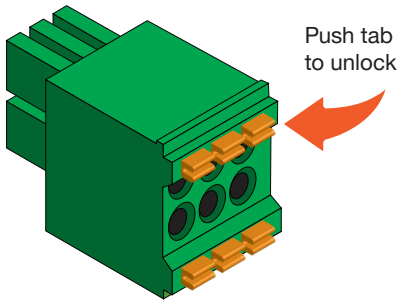

### IR emitter configuration

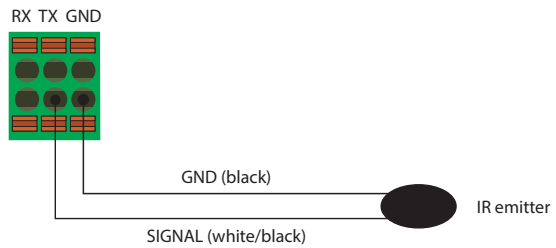

### IR extender configuration

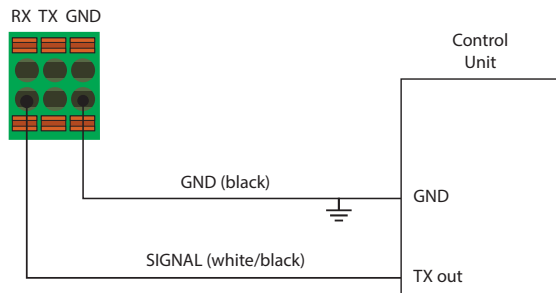

## Connection Instructions

1. Connect an Ethernet cable from the **ETHERNET** port on the encoder to a PoE-capable switch on the Local Area Network (LAN). If using the dual-channel encoder, connect separate Ethernet cables to **ETHERNET 1** and **ETHERNET 2** ports.



**IMPORTANT:** If a PoE-capable switch is not available, then the 48V DC power supply (sold separately) must be connected to the encoder.

2. Connect an HDMI cable from each source to the **HDMI** ports on the encoder.
3. RS-232 (optional)
  - Connect the RS-232 controller/automation system to the **RS-232** port on the encoder.
  - Connect the RS-232 device to the **RS-232** port on the decoder.
4. IR (optional)
  - **IR emitter**  
Connect the IR emitter to the **TX** and **GND** pins of the **RS-232 2** port. The IR emitter must be placed no more than one inch from the IR sensor on the device, in order to function properly.
  - **IR extender**  
Connect the IR extender from the **RX** and **GND** pins of the **RS-232 2** port to the associated pins on the control system.
5. Once power is applied, the **PWR** indicator, on the front panel, will turn red, then amber, then green.

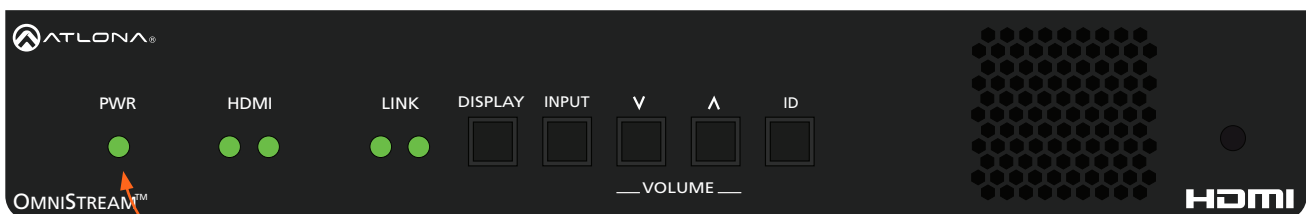

PWR indicator

### Connection Diagram

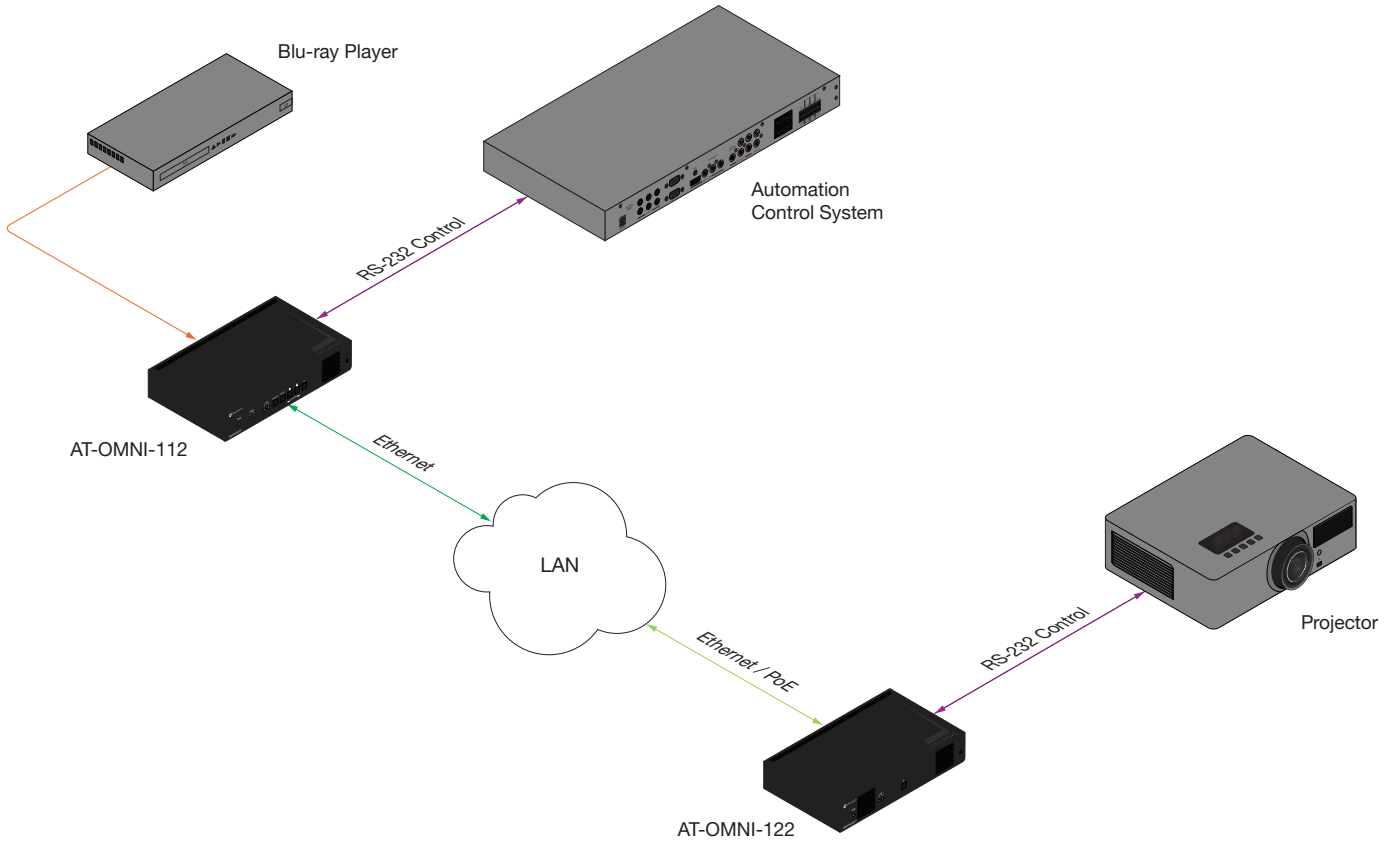

# Configuration

## Accessing Encoders in AMS

It is recommended that the Atlona Management System (AMS) be used to configure and control OmniStream devices. AMS uses multicast Domain Name Server (mDNS) to automatically discover each encoder on the network. AMS is free and can be downloaded from <https://www.atlona.com/ams>.

By default, the encoders are set to DHCP mode, allowing a DHCP server (if present) to assign the encoder an IP address. Once an IP address has been assigned, the Atlona Management System (AMS) can be used to manage the product on the network. Note that AMS will only be able to discover encoders if they are on the same VLAN.

In order for AMS to automatically assign multicast IP addresses to OmniStream encoders, the destination IP addresses for the session streams must be cleared.

**NOTE:** The following steps are required *only if a pre-existing multicast IP address* is assigned to each session and if automatic assignment of these multicast IP addresses, using AMS, is desired.

1. Launch a web browser and enter the IP address of AMS, in the address bar.
2. Enter the required login credentials. The default login is:

Username: admin  
 Password: Atlona

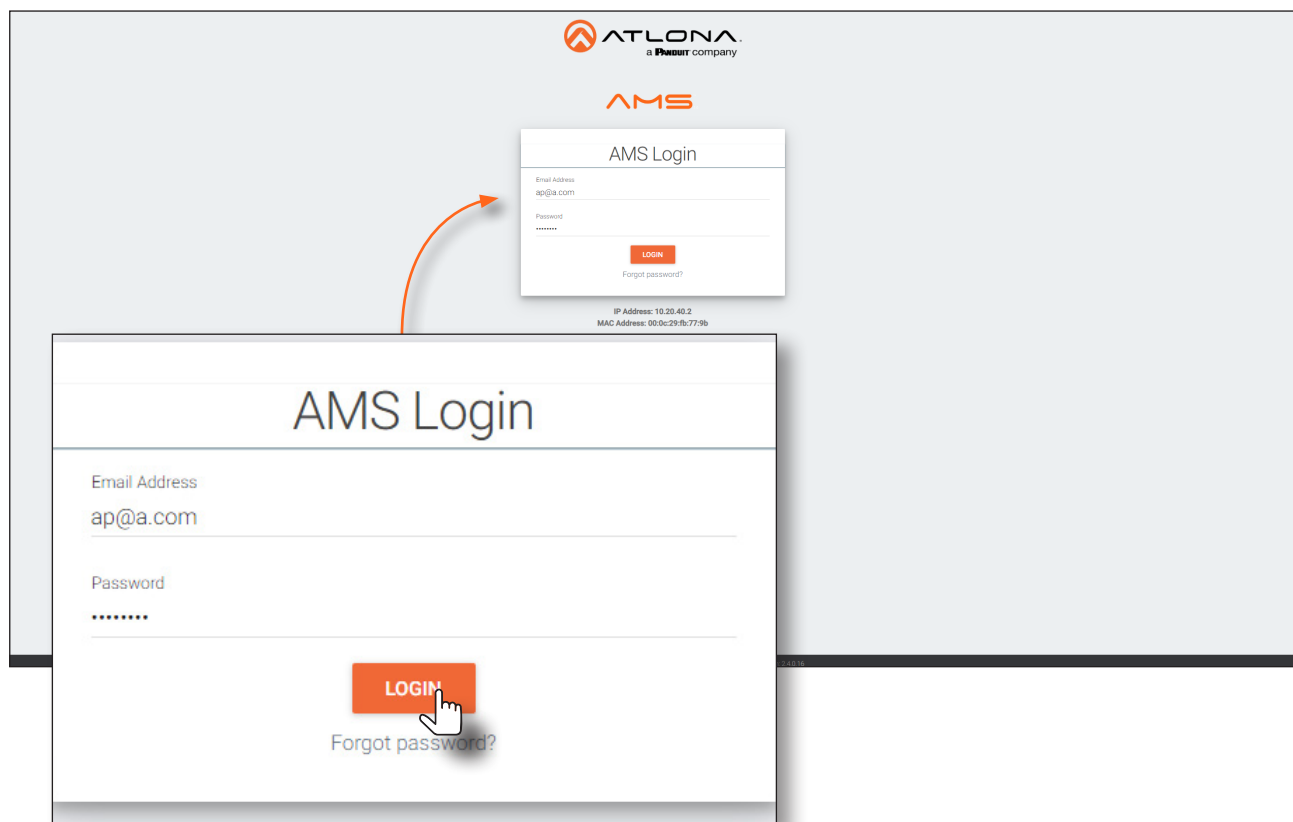

3. Click the **Login** button.
4. The AMS Dashboard will be displayed.
5. Click the ☰ icon, in the upper-left corner of the AMS Dashboard.



6. Click **Devices** from the fly-out menu.

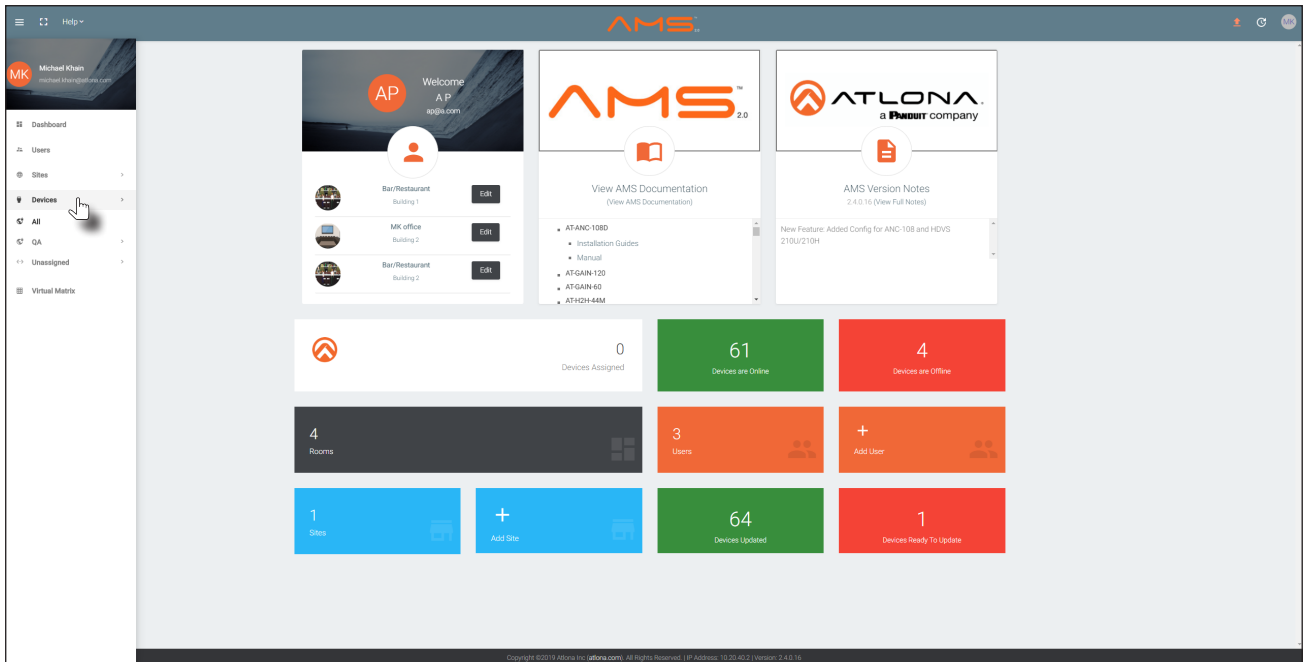

7. Click the **Unassigned** option.

8. Click the left and right arrows, at the bottom of the **Unassigned** list, to scroll through all available devices.

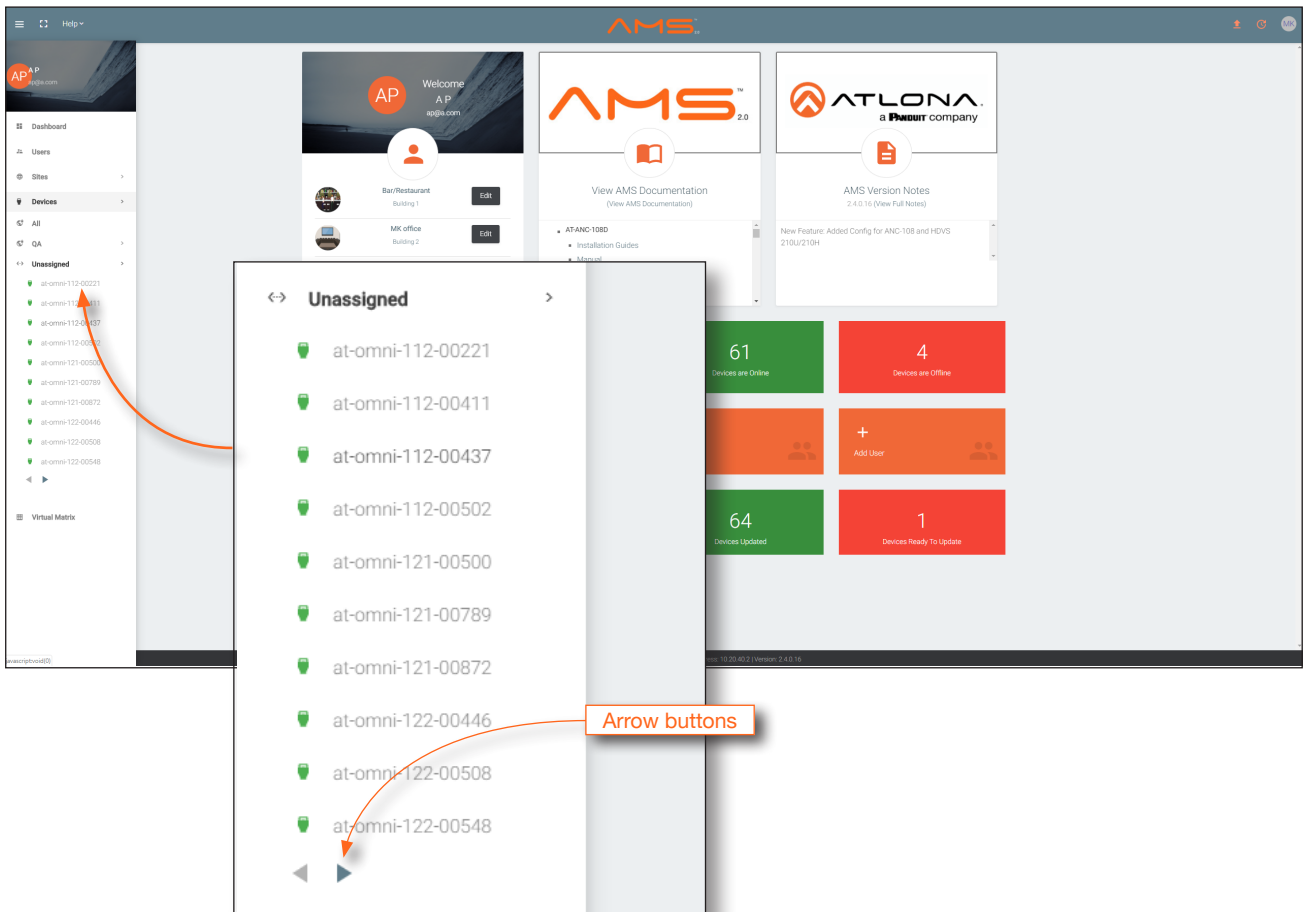

All available encoders will be displayed under the **Unassigned** category. When an encoder is unassigned, it means that it has not been assigned to a site, building, and/or room. Refer to the AMS User Manual for more information on these topics.

If a DHCP server is not found within 60 seconds, the encoder will be placed in Auto IP mode and assigned an IP address within the range of 169.254.xxx.xxx. If this occurs, configure the network interface of the computer that is running AMS, located on the same subnet (169.254.xxx.xxx, subnet mask 255.255.0.0). Refer to [Configuring a Static IP Address \(page 20\)](#) for more information on configuring an encoder in Auto IP mode.

If no OmniStream encoders are found, then verify the following:

- The computer that is running AMS must be on the same network as the OmniStream device.
- Remove any network restrictions that may be in place. In order for mDNS to function properly, there must not be restrictions applied to the network.

9. Click the desired encoder within the **Unassigned** list.

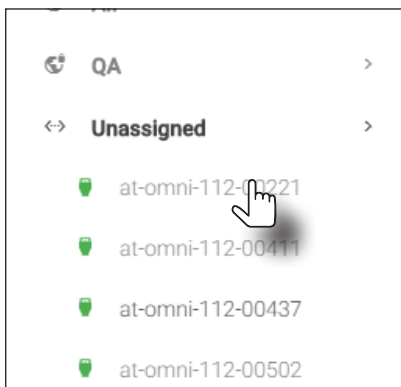

10. Once the unit is selected, the control interface for the encoder will be displayed. The illustration below shows the **DEVICE INFO** screen for an AT-OMNI-112 encoder.

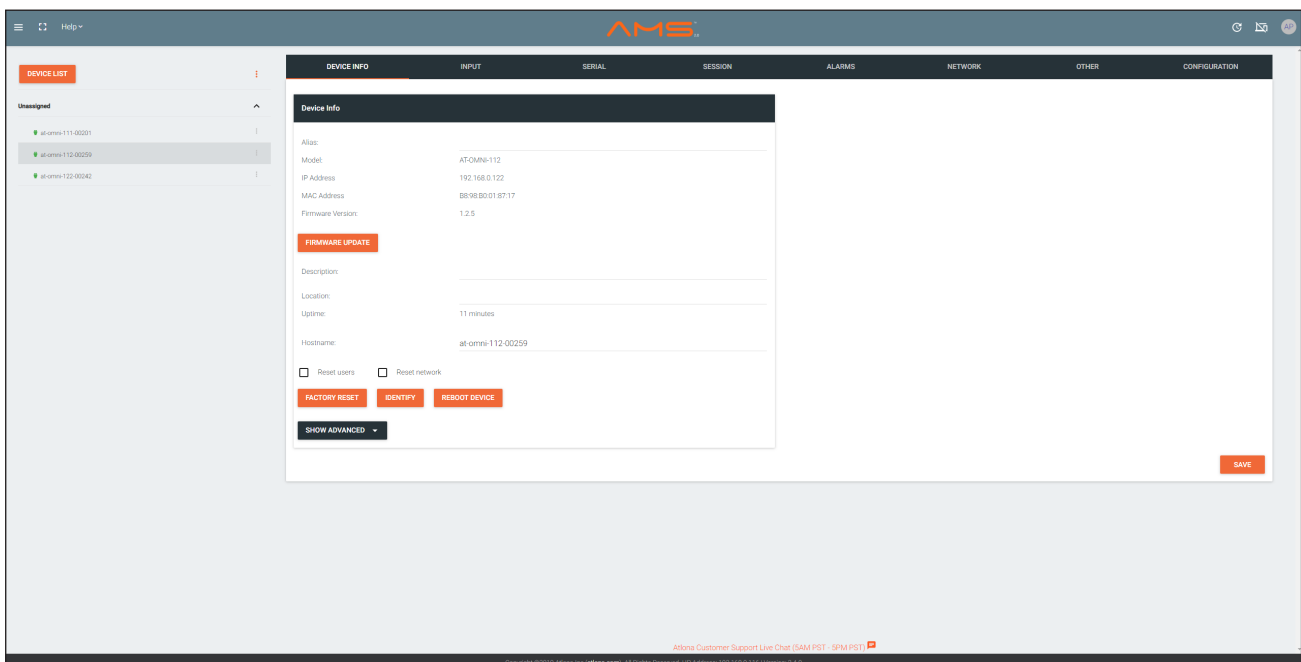

11. Click **SESSION** in the top menu bar.

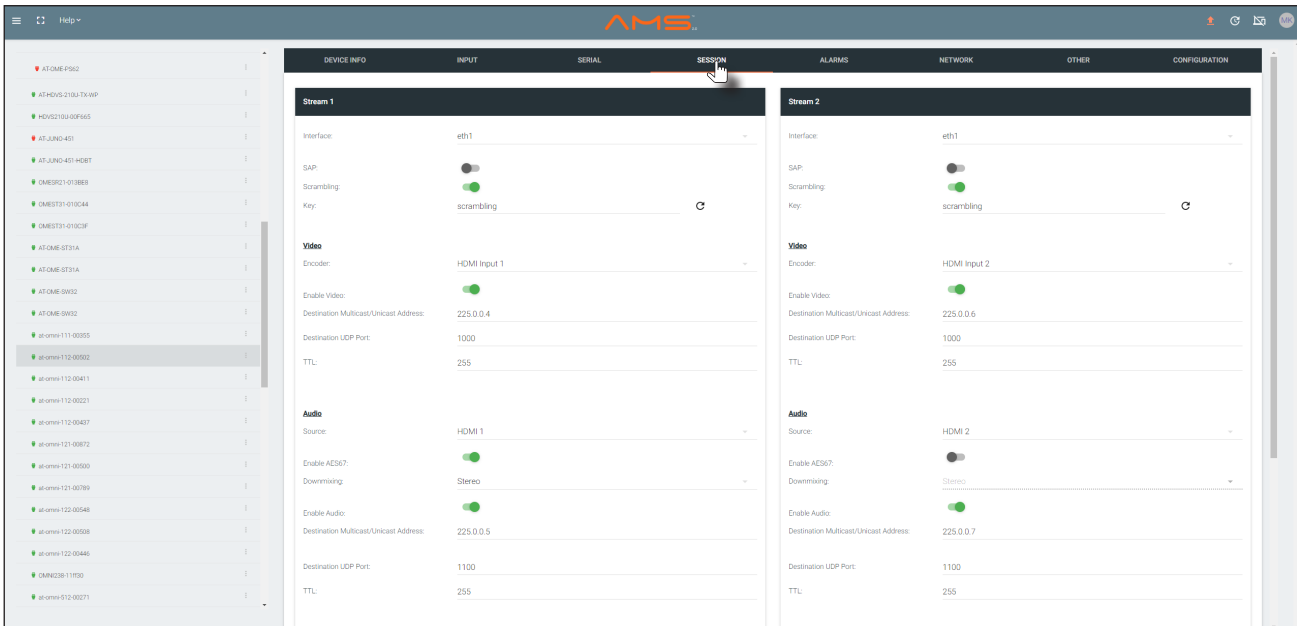

12. Locate the **Video** section.

13. Delete the value in the **Destination Multicast / Unicast Address** field.



14. Locate the **Audio** section and delete the value in the **Destination Multicast / Unicast Address** field.

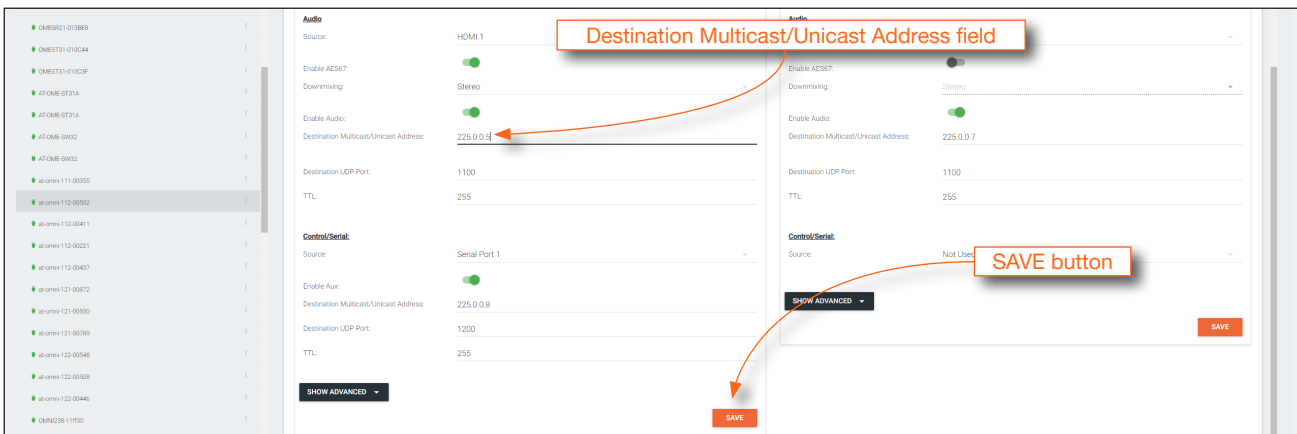

15. Scroll down to the bottom of the page and click the **SAVE** button at the bottom of the **Stream 1** window group.

16. Repeat steps 12 through 15 under for **Stream 2** (dual-channel encoder only), if required. If there are multiple encoders on the system, then these steps will need to be completed for each encoder.

## Configuring a Static IP Address

The following section is only required to when setting an encoder to a static IP address. If a DHCP server is not found within 60 seconds, encoders are automatically placed in Auto IP mode and will be assigned an IP address within the range 169.254.xxx.xxx. If this occurs, a static IP address can be assigned to the encoder in order for AMS to locate it on the network.

1. Make sure that the encoder is powered. Power will need to be supplied either by the external 48V power supply (not included) or by connecting an Ethernet cable from the encoder to a PoE-capable switch. If using the AT-OMNI-112, the Ethernet cable can be connected to either **ETHERNET 1** or **ETHERNET 2** (dual-channel only).
2. Connect an Ethernet cable from the PC, directly to one of the Ethernet ports on the encoder. Make sure that the computer being used has AMS installed.
3. Configure the PC to a static IP address that is on the same subnet as the encoder.



**IMPORTANT: Windows:** Before continuing, write down the current IP settings in order to restore them, later. If *Obtain an IP address automatically* and *Obtain DNS server automatically* are selected, then this step is not required.

4. Login to AMS. Refer to [Accessing Encoders in AMS \(page 16\)](#) for information on the login process.
5. Locate the encoder under the **Unassigned** section within AMS.
6. Click on the device.
7. Under AMS, click **NETWORK** in the menu bar.

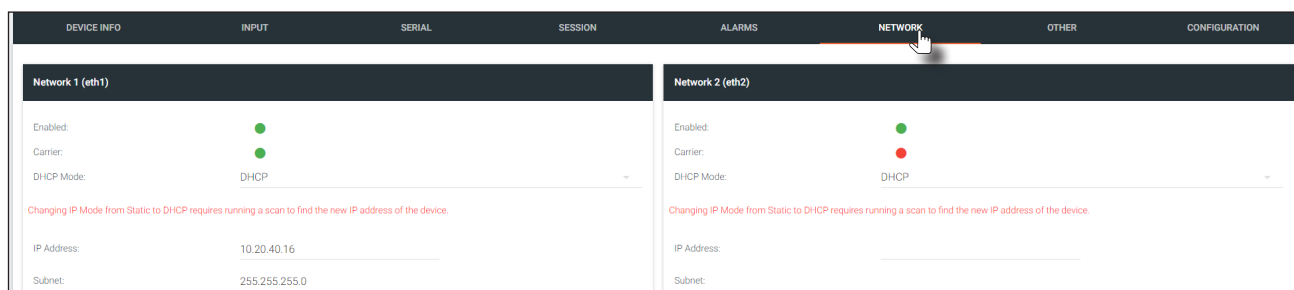

8. Click the **DHCP Mode** drop-down list and select **Static**.

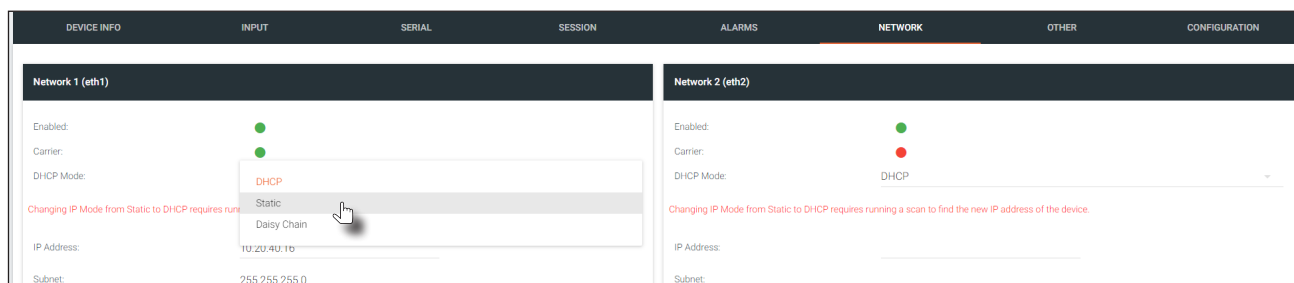

9. Enter the required network information for the encoder in the **IP Address**, **Subnet**, and **Gateway** fields.
10. Click the **Save** button in the bottom-right corner, to apply the changes.
11. Disconnect the encoder from the PC and connect the encoder to the network.
12. The encoder is now ready for use.

## Input Selection

Once the OmniStream encoder is configured, and can be located on the network, the encoder will need to be instructed on how to handle source devices and to which stream each source is assigned.

### Input Selection

1. Under AMS, click **INPUT** in the menu bar.
2. Click the **Input** drop-down list for **HDMI Input 1** and select the input.

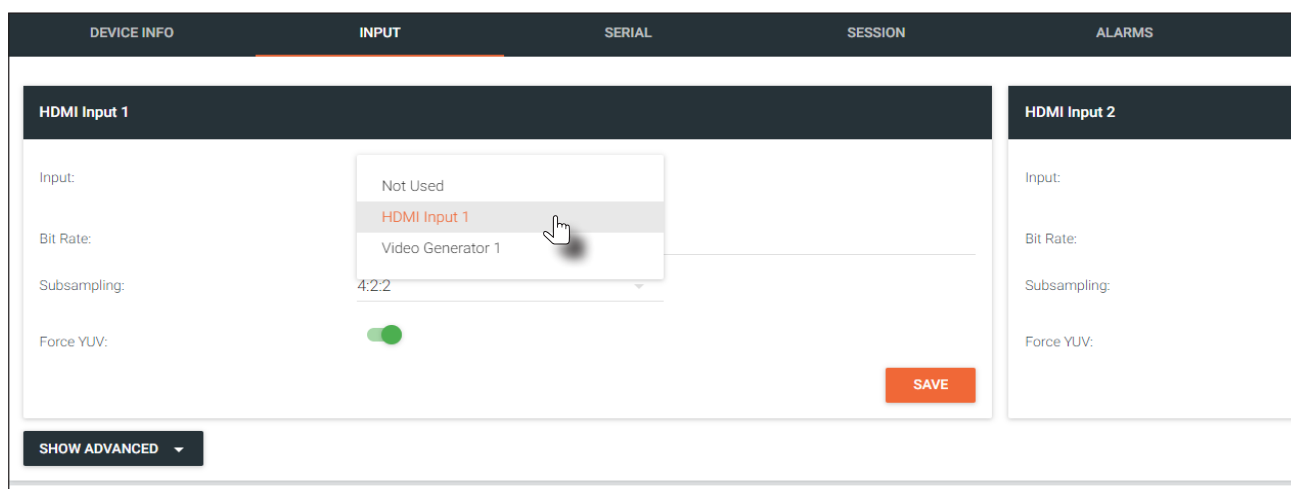

3. Enter the desired bit rate in the **Bit Rate** field. Specifying lower bit rates will reduce video quality. This value is in megabits-per-second (Mbps). 4K/UHD streams should be set to 900 Mbps. The recommended bandwidth for 1080p60 video is also 450 Mbps. Setting this field below these recommended values will result in lower-quality video.
4. Enter the bit depth from the **Bit Depth** drop-down list.
5. Select the chroma subsampling value from the **Subsampling** drop-down list. Available values are 4:2:0, 4:2:2, and 4:4:4.
6. Click the **Force YUV** toggle switch to enable or disable the use of YUV color space. Enable (the toggle switch will be green) this feature to force the output of the encoder to output YUV, regardless of whether the input is RGB or YUV. In order for the chroma scaling to work on RGB inputs, this feature must be enabled.

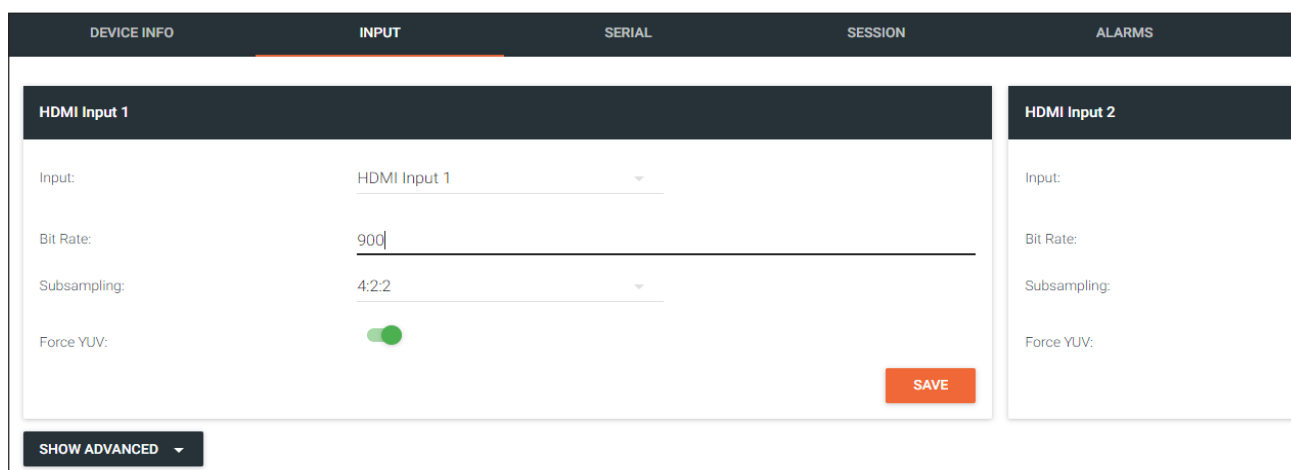

### Dual-channel encoder only:

- Repeat the above steps for the Encoder 2 section (dual-channel OmniStream only). If a secondary HDMI source is not connected to the encoder, then these fields may be left at their current settings.

### Dual-channel / single-channel encoder:

- Click the **SAVE** button in the right-hand corner of the **HDMI Input 1** window group to commit changes.

### Verifying the Input

- Click **INPUT** in the menu bar.

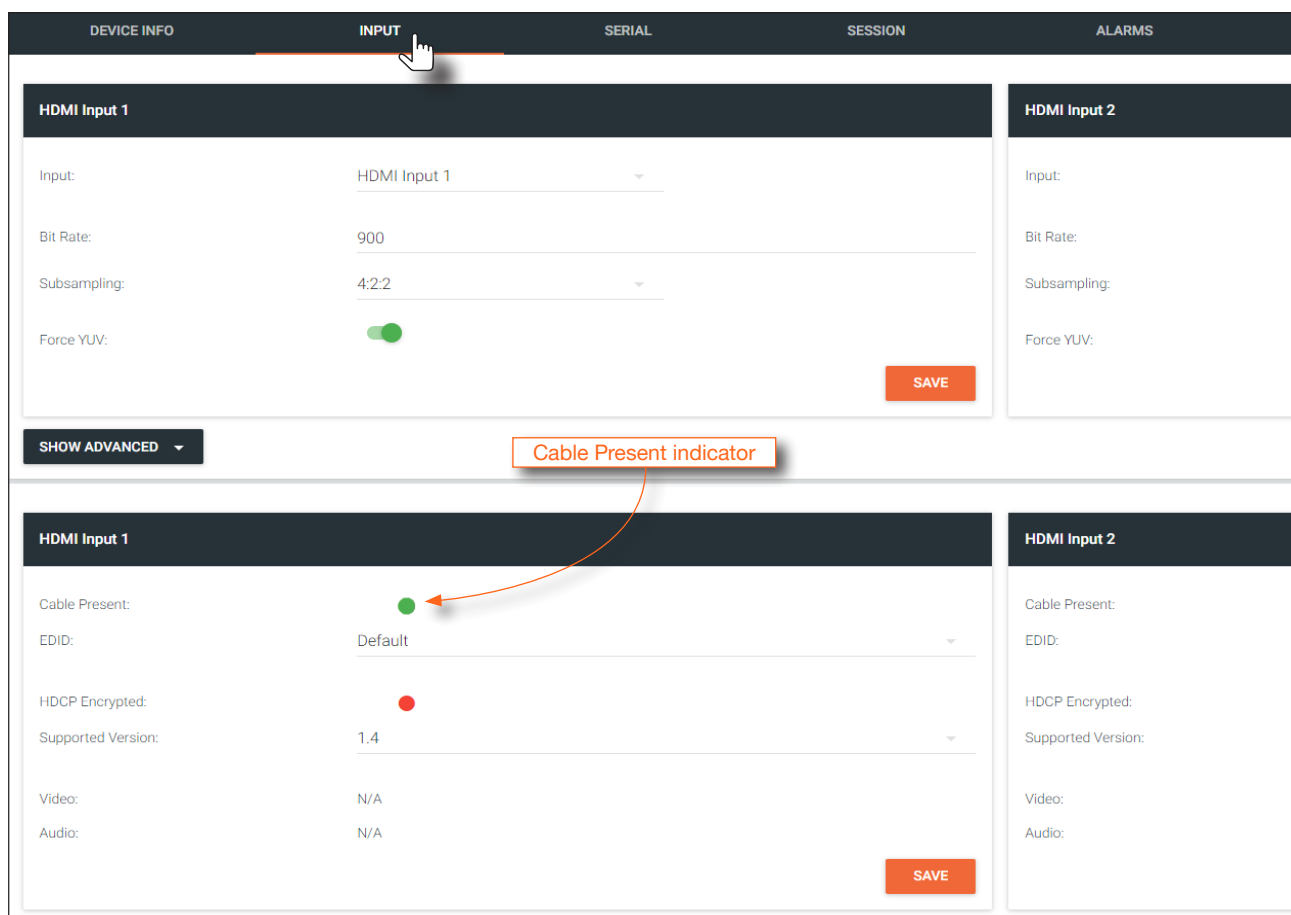

The screenshot displays the configuration interface for the encoder. The top navigation bar includes 'DEVICE INFO', 'INPUT', 'SERIAL', 'SESSION', and 'ALARMS'. The 'INPUT' menu is selected, and a hand cursor points to it. Below the navigation bar, there are two main sections for 'HDMI Input 1' and 'HDMI Input 2'. The 'HDMI Input 1' section is expanded, showing various settings: 'Input' (HDMI Input 1), 'Bit Rate' (900), 'Subsampling' (4:2:2), and 'Force YUV' (checked). A 'SAVE' button is visible in the bottom right corner of this section. Below the main settings, there is a 'SHOW ADVANCED' dropdown menu. In the expanded 'HDMI Input 1' section, the 'Cable Present' indicator is shown as a green dot, which is highlighted by a red box and an arrow labeled 'Cable Present indicator'. Other indicators include 'EDID' (Default), 'HDCP Encrypted' (red dot), 'Supported Version' (1.4), 'Video' (N/A), and 'Audio' (N/A). A 'SAVE' button is also present at the bottom right of this expanded section.

- Check the **Cable Present** indicator. If a cable is connected from a source to an input on the encoder, then the indicator will be green. If no cable is connected, then the indicator will be red.

Note that this indicator may also reflect the integrity of the cable: if the cable is bad or does not maintain a secure connection, then the **Cable Present** indicator may also be displayed as red. If this is the case, try a different HDMI cable.

## Session Configuration

Once the inputs have been assigned to the desired source, the next step is to configure each *session*. A *session* is a class-D multicast IP address that is assigned to an AV stream. If each stream is configured for bit rates less than 450 Mbps (only recommended for 1080p and lower resolutions), a single Ethernet cable can transport two sessions. The dual-channel encoder supports up to four sessions, which allows for redundancy in dual 1080p-use cases. The single-channel encoder supports a maximum of two sessions to enable redundancy for single 1080p-use cases.

## Video

1. Under AMS, click **Session** in the menu bar.
2. Click the desired physical interface from the **Interface** drop-down list: **eth1** or **eth2**.
3. Select the desired encoder session from the **Encoder** drop-down list: **HDMI Input 1** or **HDMI Input 2**.
4. Under the **Video** section, make sure that the **Enable Video** toggle switch is enabled (green). To disable video at any time, click the toggle switch so that it appears gray.
5. Enter the destination multicast IP address in the **Destination Multicast/Unicast IP Address** field, within the range 224.0.0.0 through 239.255.255.255.
6. Enter the port number in the **Destination UDP Port** field.

## Audio

1. Locate the **Audio** section.
2. Click the **Source** drop-down list and select the HDMI source.



**NOTE:** If AES67 audio will be used, refer to [AES67 Audio \(page 57\)](#) for more information.

3. Click the **Enable Audio** toggle switch and make sure it is enabled (green). To disable audio at any time, click the toggle switch so that it appears gray.
4. Enter the specific destination IP address, if desired, in the **Destination Multicast/Unicast IP Address** field. By default, AMS will automatically populate this field.
5. Enter the port number in the **Destination UDP Port** field.









**IMPORTANT:** AMS does not allow the same port numbers to be used on both video and audio. Always specify unique ports for both video and audio.

# Basic Operation

## LED Indicators

The following table provides a listing of front-panel LED indicators and their status:

LED		Description
PWR	Off 	<ul style="list-style-type: none"> <li>If using a PoE switch, make sure that the port on the switch that is connected to the encoder, has PoE enabled. When the encoder is powered using PoE, the <b>PWR</b> indicator will be green.</li> <li>Check the Ethernet cable for possible damage or loose connections.</li> <li>Connect the optional 48V DC power supply (available from atlona.com) to the encoder. When using an external power supply, the <b>PWR</b> indicator will be green.</li> </ul>
	Red 	<ul style="list-style-type: none"> <li>The encoder is booting.</li> </ul>
	Green 	<ul style="list-style-type: none"> <li>The encoder is ready.</li> </ul>
HDMI 1 / 2	Red 	<ul style="list-style-type: none"> <li>No source is connected to the input.</li> <li>Check the HDMI cable for possible damage or loose connections.</li> </ul>
	Green 	<ul style="list-style-type: none"> <li>The link integrity between the source and the encoder is good.</li> </ul>
LINK 1 / 2	Red 	<ul style="list-style-type: none"> <li>The optional 48V DC power supply is connected, but no Ethernet cables are connected between the switch and the <b>ETHERNET</b> port(s).</li> <li>Check the Ethernet cable for possible damage or loose connections.</li> </ul>
	Green 	<ul style="list-style-type: none"> <li>Link integrity is good between the encoder and the network.</li> </ul>



## Rebooting OmniStream

To reboot the OmniStream encoder, press and release the recessed button, on the far-right side of the unit, using a small, pointed object. Rebooting the encoder does not reset the encoder to factory-default settings.

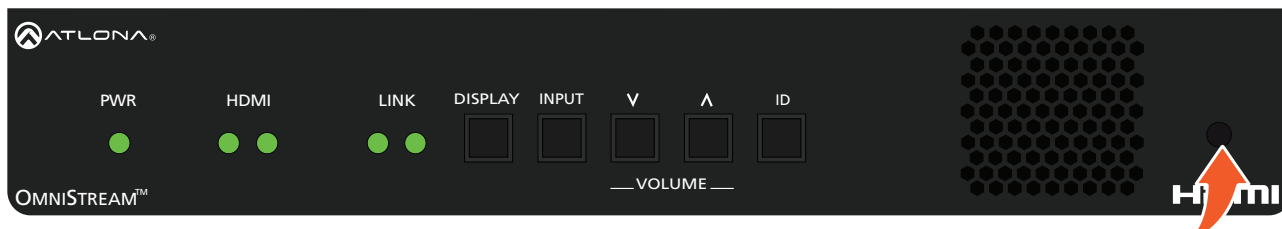

## Selecting the Input

**! IMPORTANT:** This feature is not available on the single-channel OmniStream encoder (AT-OMNI-111).

Press and release the **INPUT** button to select the desired input: **HDMI 1** or **HDMI 2**. When a new active input is selected, the previous input will remain “live”. This will allow connected devices, such as laptop computers, to remain in “presentation mode” and not revert to single-screen mode. After the input is selected, AMS will require configuration. Refer to [Input Switching Configuration](#) (page 28) for more information.

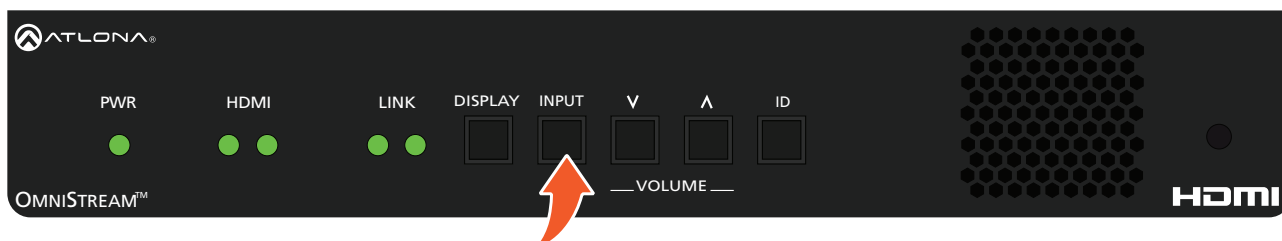

## Powering the Display

**! IMPORTANT:** This feature is not available on the single-channel OmniStream encoder (AT-OMNI-111).

Press and release the **DISPLAY** button to send the command to toggle power on the display that is connected to the decoder. The command is sent over IP. After the decoder receives the command, it is executed and transmitted to the display using RS-232 and/or CEC.

Refer to the *OmniStream Single-Channel / Dual Channel A/V Decoder User Manual*, for configuration information.

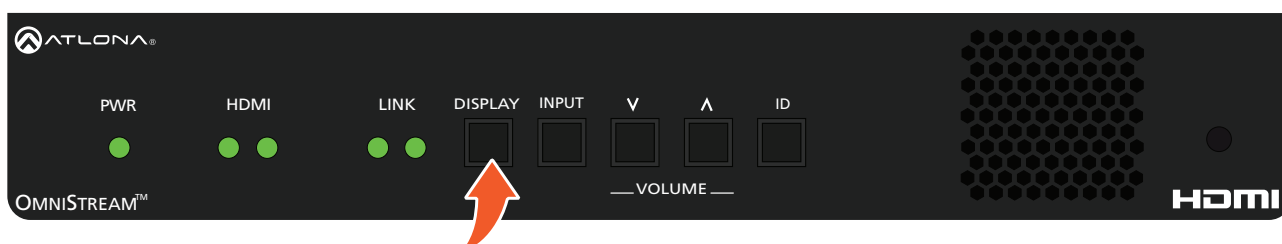

## Adjusting Volume

Refer to the *OmniStream Single-Channel / Dual Channel A/V Decoder User Manual*, for configuration information.

Press and release the **▲** (up) or **▼** (down) **VOLUME** buttons to increase or decrease the audio volume, respectively, in 1 dB increments. The volume command is sent over IP. After the decoder receives the command, it is executed and transmitted to the display using RS-232 and/or CEC. These buttons also concurrently affect the analog output port volume. The maximum audio output level is +15 dB.

When either of these buttons are pressed, the associated HDMI indicator, on the front panel, will glow bright orange to indicate that the stream is being controlled.

Press and hold either of these buttons to rapidly increase or decrease the volume.

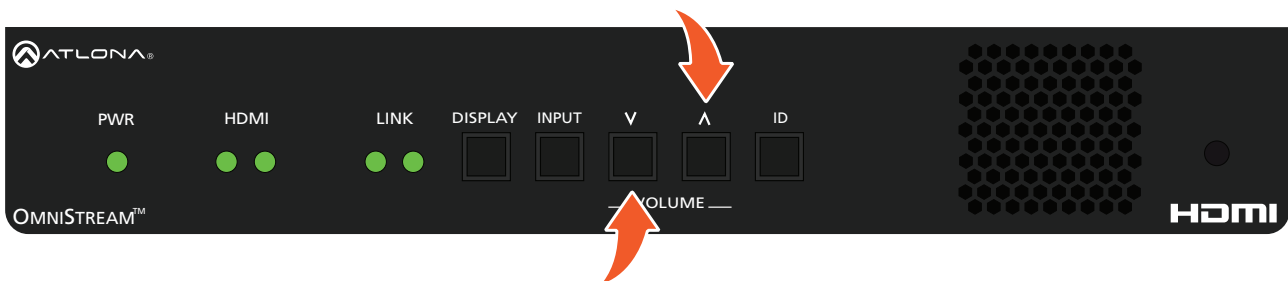

Depending upon the output mode of the encoder, the **VOLUME** buttons will behave differently.

### Single-output Mode

Press the desired **VOLUME** control button to immediately change the volume on the display.

### Dual-output Mode

OmniStream does not provide a method for managing the currently-controlled stream. To select a stream, the **INPUT** button must first be pressed. Once the stream is selected, the **VOLUME** buttons can be used to change the volume of the display. Refer to [Input Switching Configuration \(page 28\)](#) for more information.

1. Press and release the **INPUT** button to toggle between the HDMI 1 and HDMI 2 streams.
2. The current stream will be indicated by a bright orange HDMI indicator.

The following example shows HDMI 2 as the currently selected stream. If **HDMI 1** is desired, press and release the **INPUT** button.

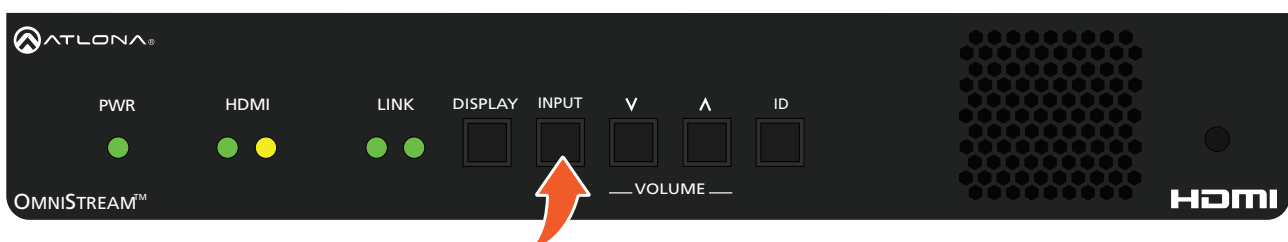

## ID Button

The **ID** button, on both the AT-OMNI-111 and AT-OMNI-112, serves two functions:

1. Sends a broadcast message over the network to any devices that may be listening.
2. Resets the encoder to factory-default settings.

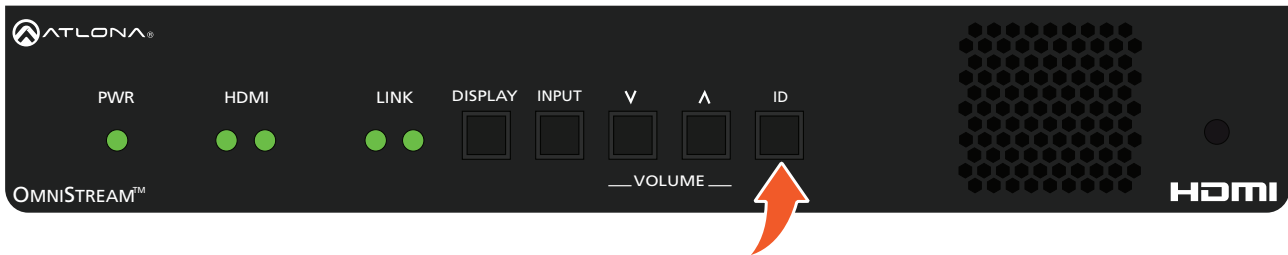

### Broadcast Messaging

Press and release the **ID** button to send a broadcast notification over the network to any devices that may be listening.

### Reset to Factory-Default Settings

1. Press and hold the **ID** button for approximately 30 seconds.
2. The LED indicators on the front panel will flash, then turn “off.”
3. The encoder is now reset and will need to be reconfigured.



**WARNING:** Performing a factory-default reset will erase all user-programmed settings from the encoder. IP settings are not preserved.

## Input Switching Configuration



**IMPORTANT:** This feature is not available on the single-channel OmniStream encoder (AT-OMNI-111).

The **INPUT** button on the front panel can be configured to switch between both HDMI inputs. This is useful in meeting room applications, allowing switching between two sources. Note that when configuring input switching, one of the encoder sessions will be lost, causing dual-channel encoders to function as single-channel encoders.

1. Verify that there are two HDMI sources are connected to the encoder.
2. Login to AMS. Refer to [Accessing Encoders in AMS \(page 16\)](#), if necessary.
3. Click **SESSION** in the menu bar.
4. Under the **Stream 2** window group, click the **Encoder** drop-down list and select **Not Used**.

It should be noted that **Not Used** could have been set under **Stream 1**, instead. The concept is to remove the source assignment from either **Stream 1** or **Stream 2**.

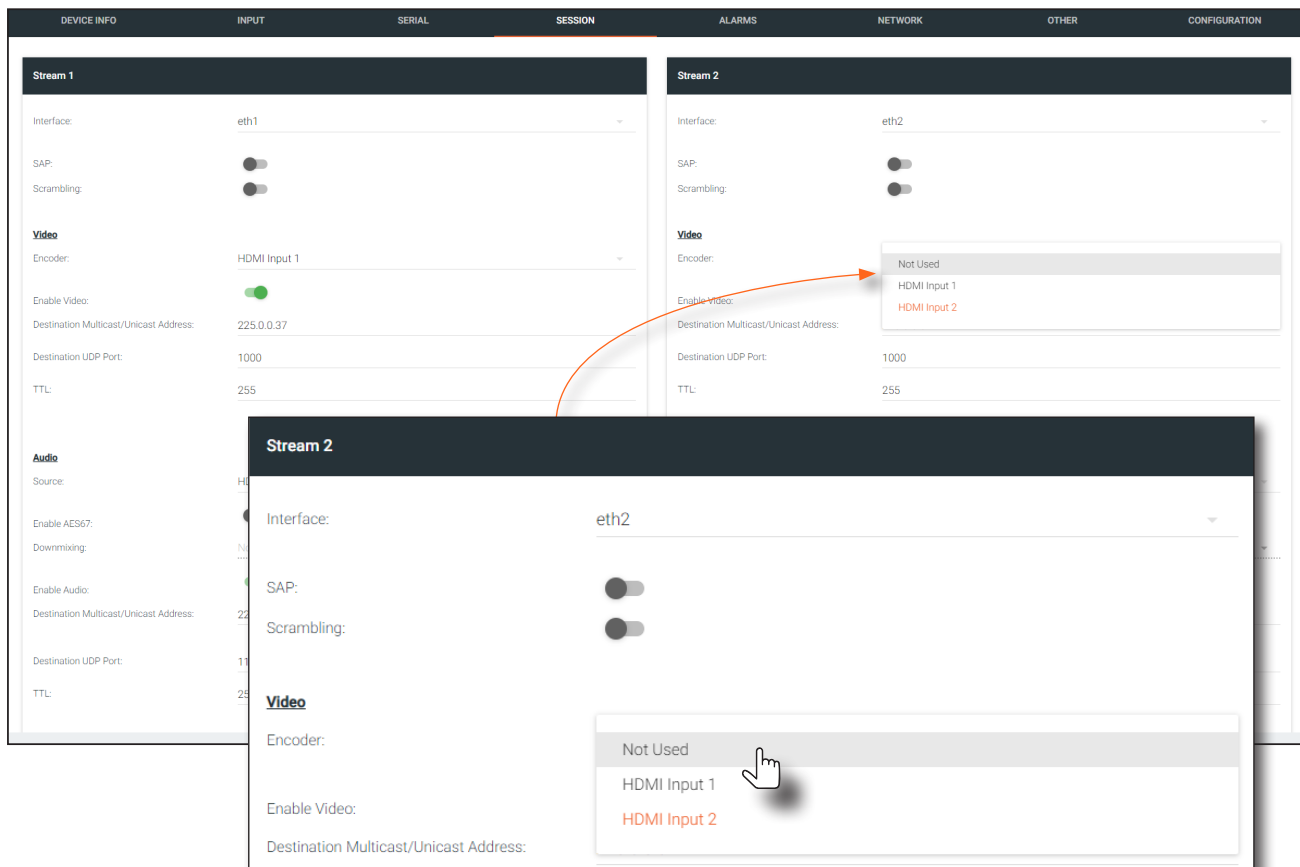

The screenshot displays the AMS configuration interface for two streams. The top navigation bar includes tabs for DEVICE INFO, INPUT, SERIAL, SESSION, ALARMS, NETWORK, OTHER, and CONFIGURATION. The main content area is divided into two columns for Stream 1 and Stream 2. Stream 1 is configured with interface eth1 and encoder HDMI Input 1. Stream 2 is configured with interface eth2 and encoder Not Used. A red arrow points from the 'Encoder' dropdown in Stream 2 to the 'Not Used' option. A mouse cursor is shown hovering over the 'Not Used' option in the dropdown menu.

5. Click the **SAVE** button, under **Stream 2** to commit the changes.
6. Configuration is complete.
7. Press the **INPUT** button on the front panel of the encoder to switch between **HDMI IN 1** and **HDMI IN 2**. To return the encoder to the previous state (disable input switching), assign the **Encoder** field, under the **Stream 2** window group, to **HDMI Input 2**.

## Unicast Mode

The term *unicast* is used to describe a configuration where information is sent from an encoder to a single decoder. Although it is common to have multiple encoder and decoder units within a system, it may also be desirable to restrict a single encoder to communicate with one decoder. In *unicast* mode, OmniStream encoders and decoders function similar to an n x 1 switcher. Changing the destination IP address at the encoder, will direct the stream to be received by a different decoder.

The illustration below shows three encoders and three decoders on a network, operating in *unicast* mode. The red lines indicate the data paths from each encoder to a separate (single) decoder.



**NOTE:** By default, both encoders and decoders are shipped in multicast mode.

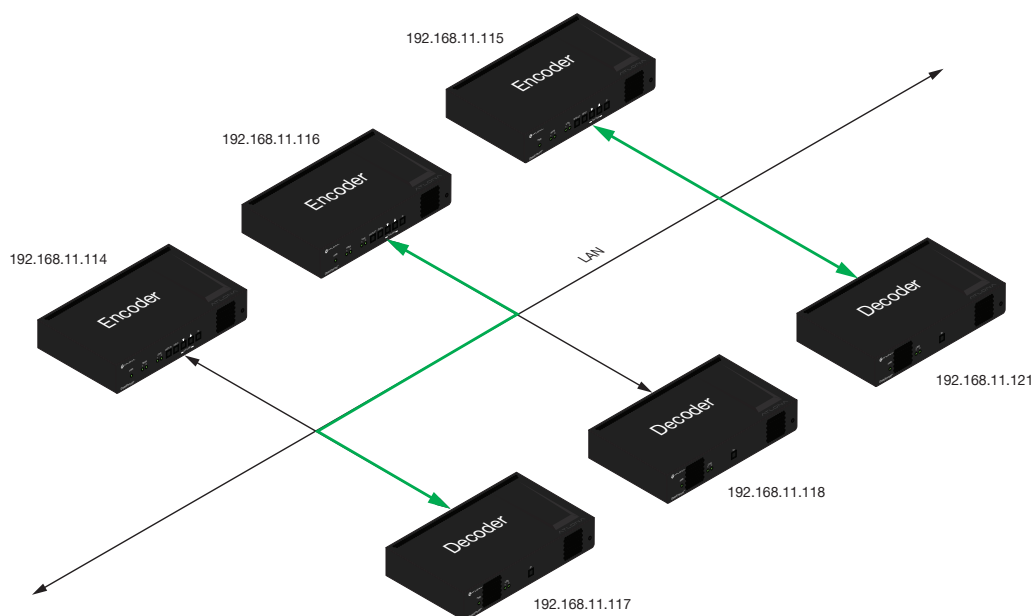

1. Login to AMS. Refer to [Accessing Encoders in AMS \(page 16\)](#), if necessary.
2. Click **SESSION** in the menu bar and locate the **Video** section.
3. Enter the IP address of the decoder in the **Destination Multicast/Unicast Address** field. If using dual-channel encoders, repeat this process for each stream.

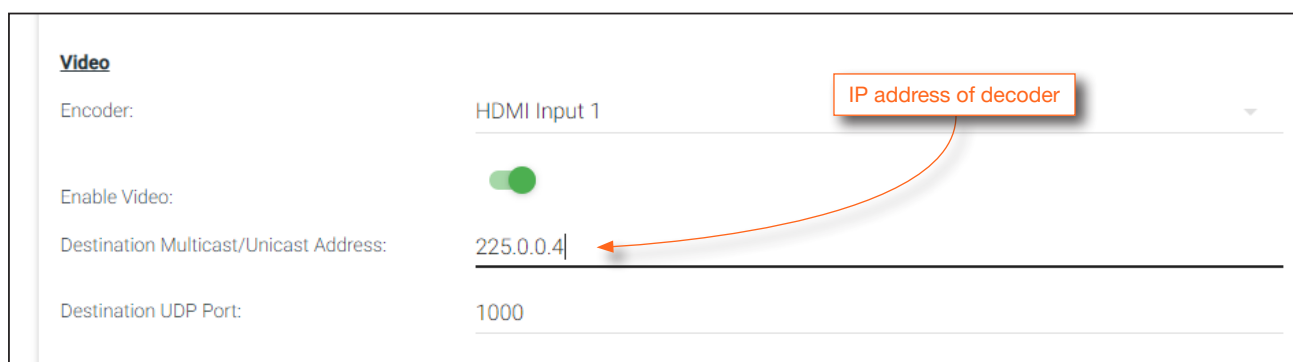

4. Scroll down to the bottom of the page and click the **SAVE** button to commit all changes.

5. Go to the decoder AMS interface. Refer to the *OmniStream Single-Channel / Dual Channel A/V Decoder User Manual*, if necessary.
6. Click **IP INPUT** from the menu.
7. Remove the IP address from the **Multicast Address** field.
8. Click the **SAVE** button to commit changes.



**IP Input 1 (Video 1)**

Enabled:

Interface: eth1

Multicast Address:

Port: 4

**SAVE**

Field should be blank

9. Unicast setup is complete. The decoder unit will now receive streams exclusively from the encoder containing the IP address of this decoder.

### Multicast Mode

The term *multicast* is used to describe a configuration where information is sent from one or more points to a set of other points. For example, a single encoder can transmit data to multiple decoders. In addition, if multiple encoders are used, each encoder can stream data to any decoder that is not already receiving data from an encoder. In *multicast* mode, the OmniStream encoders and decoders function similar to a matrix switcher.

The illustration below shows three encoders and three decoders on a network, operating in *multicast* mode, where multiple decoders are subscribed to a single encoder. The red lines indicate the data paths from an encoder (192.168.11.117) to multiple decoders.



**NOTE:** By default, both encoders and decoders are shipped in multicast mode.

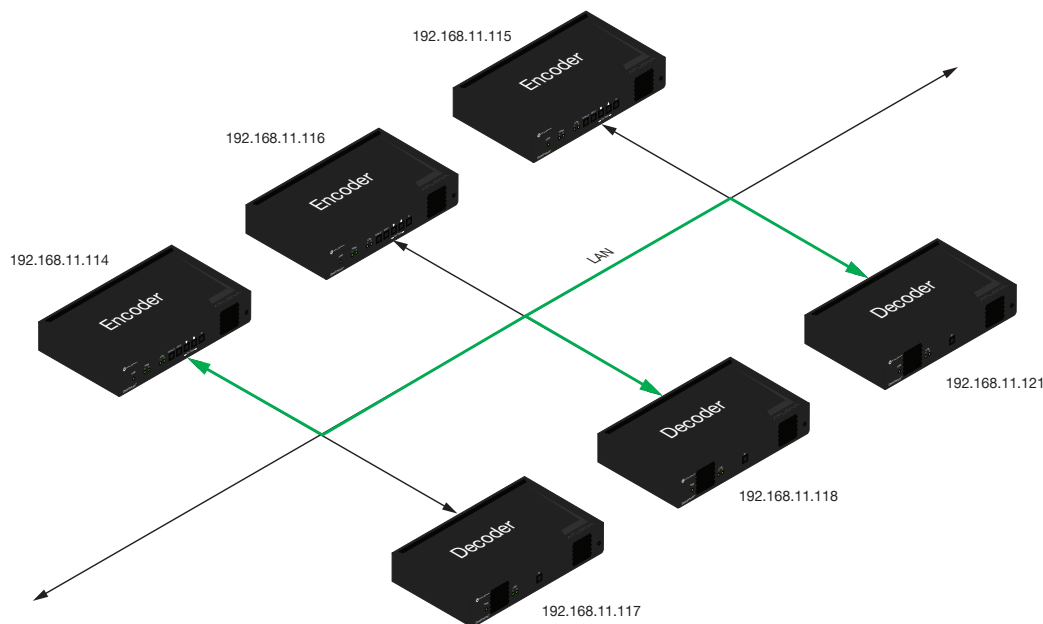

1. Login to AMS. Refer to [Accessing Encoders in AMS \(page 16\)](#), if necessary.
2. The AMS Dashboard will be displayed.
3. Click the  icon, in the upper-left corner of the AMS Dashboard.
4. Click **Virtual Matrix** from the fly-out menu. Refer to [The Virtual Matrix \(page 93\)](#), if necessary.
5. Locate the desired encoder in the Virtual Matrix, as shown on the next page.
6. Create a cross-connection to the desired decoder. When a cross-connection is created, AMS will automatically assign a multicast IP address to both the encoder and decoder. By default, AMS automatically assigns a multicast IP address to each OmniStream encoder and decoder.

Refer to the illustration on the following page, if necessary.

### OmniStream Virtual Matrix

Encoders / Decoders **LEGEND**

Encoder / Decoder	IP Address	Status	AT-OMNI-121	Andrew's AT-OMNI-122	AT-OMNI-122	AT-OMNI-521
AT-OMNI-121 192.168.11.34 at-omni-121-00461	192.168.11.34	Connected	HDMI 1	HDMI 1	HDMI 2	HDMI 1
Andrew's AT-OMNI-122 192.168.11.117 at-omni-122-00548	192.168.11.117	Connected	HDMI 1	HDMI 1	HDMI 2	HDMI 1
AT-OMNI-122 192.168.11.86 192.168.11.87 at-omni-122-00242	192.168.11.86 192.168.11.87	Connected	HDMI 1	HDMI 2	HDMI 1	HDMI 2
AT-OMNI-521 192.168.11.39 at-omni-521-00064	192.168.11.39	Connected	HDMI 1	HDMI 1	HDMI 2	HDMI 1
AT-OMNI-111 192.168.11.50 at-omni-111-00200	192.168.11.50	Connected	HDMI 1			
AT-OMNI-112 192.168.11.178 at-omni-112-00349	192.168.11.178	Connected	HDMI 1			
Andrew's AT-OMNI-112 192.168.11.116 at-omni-112-00722	192.168.11.116	Connected	HDMI 1			
AT-OMNI-112 192.168.11.178 at-omni-112-00349	192.168.11.178	Connected	HDMI 2			

Matrix cells contain connection status icons: a green checkmark in the cell for AT-OMNI-112 (HDMI 2) to AT-OMNI-122 (HDMI 1), and blue checkmarks in the cells for AT-OMNI-112 (HDMI 1) to AT-OMNI-122 (HDMI 2) and AT-OMNI-112 (HDMI 2) to AT-OMNI-521 (HDMI 1). A red arrow points from the green checkmark to a callout box.

Callout box showing a green checkmark icon with a mouse cursor pointing to it, and two square icons below it.



# IR Control

## Controlling the Display using the Display's IR Remote

The same port that provides RS-232 connections also supports bidirectional IR pass-through, allowing a device to be controlled from either the headend or the decoder endpoint. This step is optional. IR control is only supported on **RS-232 2** port (bottom set of connectors).

The following sections provide step-by-step instructions for the following topics:

- Controlling the Display using the Display's IR Remote
- Controlling the Display using a Control System

The illustration below shows a display device being controlled from the encoder. Refer to the next page for details on how to connect the IR emitter and IR receiver.

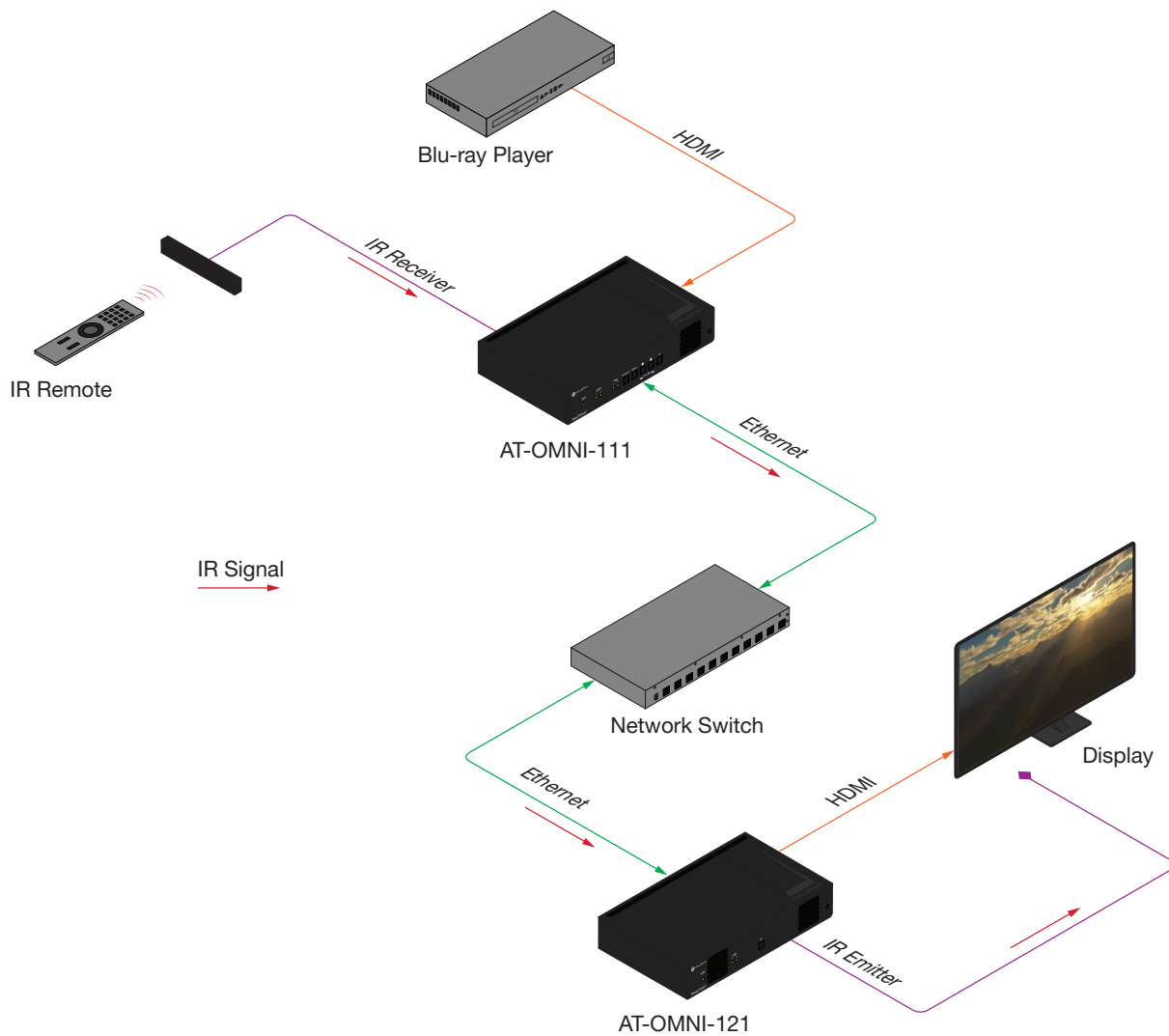

## Required Equipment

Atlona has tested and verified the following components for this application. However, other components may also be used. Note that IR control is only supported on **RS-232 2** port (bottom set of connectors) of the OmniStream encoder and decoder.

- Xantech 789-44 4-Source Connecting Block
- Xantech 12 V PSU
- IR Receiver (Atlona AT-IR-CS-RX)
- IR Emitter (Atlona AT-OMNI-IR-TX)

## Connecting the IR Receiver to the Encoder

1. Unscrew the captive screw connectors on the Xantech 789-44 4-Source Connecting Block, using a regular screwdriver, and connect the SIGNAL, GROUND, and POWER leads of the AT-IR-CS-RX to the Xantech 789-44 4-Source Connecting Block, as shown below. The presence or absence of white markings on each wire of the AT-IR-CS-RX will denote the signal type:

IR IN	= Dashed dark gray line
GND	= Solid (no marking) black wire
+12 VDC	= solid dark gray line

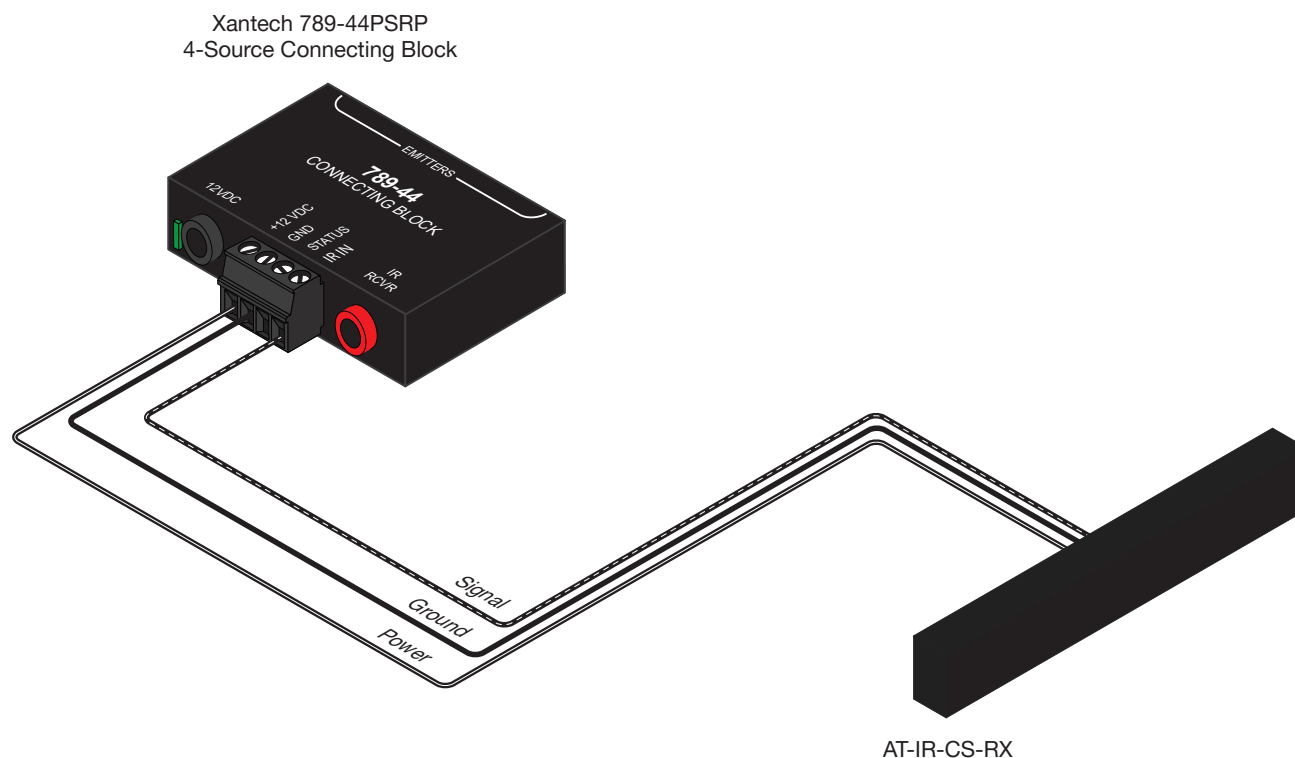

2. Connect the IR IN and GND leads, from the 789-44 4-Source Connecting Block, to the **RX** and  $\perp$  pins, respectively, of the **RS-232 2** port (bottom port) of the encoder, as shown.

**NOTE:** The IR IN, GND, and +12 VDC wires, from Step 1, have been removed from the illustration below, for purposes of clarity.

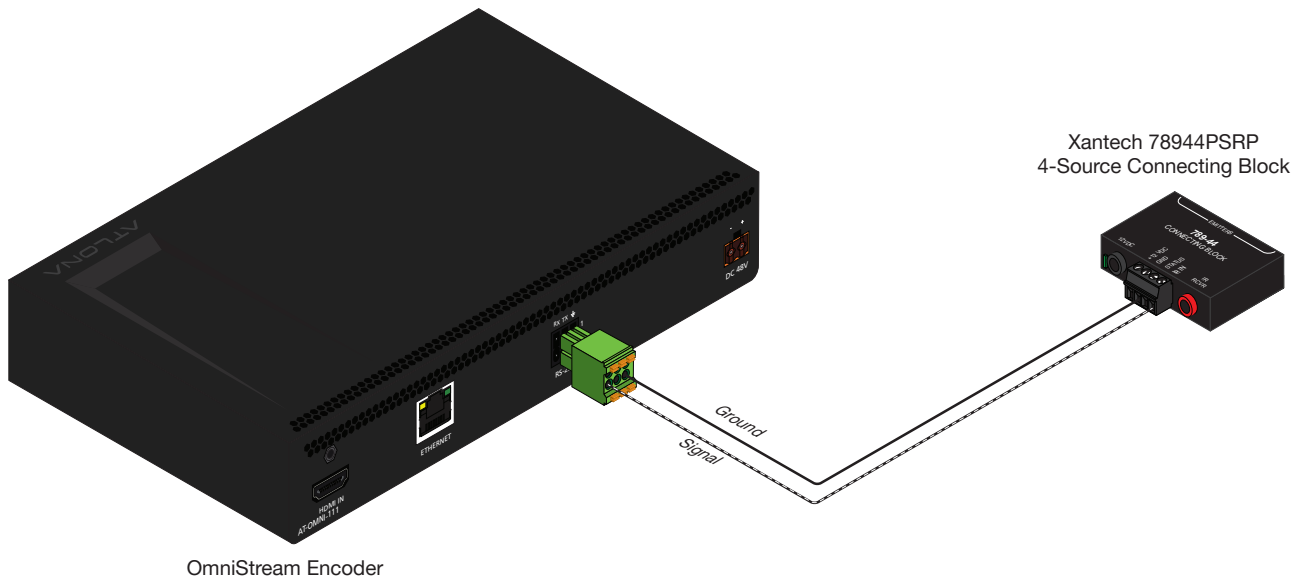

3. Connect the Xantech 12 V power supply (or other compatible 12 V DC power supply) to the 12VDC connector on the Xantech 789-44 4-Source Connecting Block.

### Connecting the IR Emitter to the Decoder

1. Connect the included 6-pin Euroblock push-spring connector to the **RS-232 2** port on the encoder.
2. Connect the SIGNAL wire of the AT-OMNI-IR-TX, to the **TX** (middle) terminal on the **RS-232 2** port.
3. Connect the GROUND wire of the AT-OMNI-IR-TX to the  $\perp$  terminal on the **RS-232 2** port.

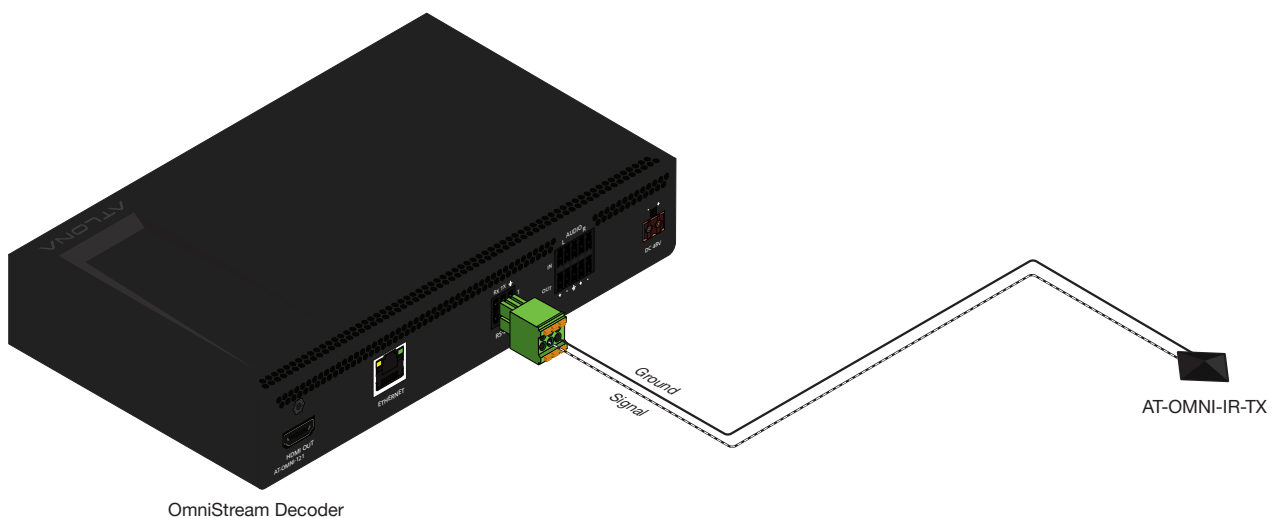

## Identifying the Encoder using AMS

1. Launch a web browser and enter the IP address of AMS in the address bar.
2. Enter the required login credentials. The default login is:  
  
Username: admin  
Password: Atlona
3. Click the **Login** button.
4. The AMS Dashboard will be displayed.
5. Click the ☰ icon, in the upper-left corner of the AMS Dashboard.

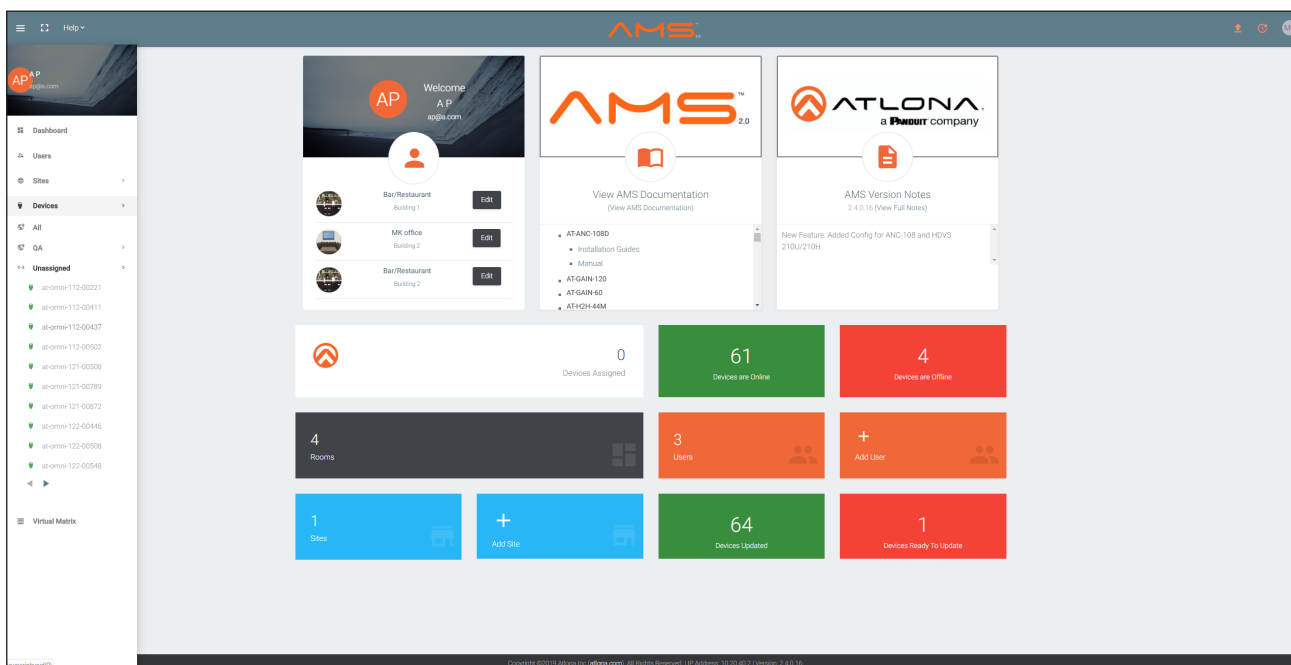

6. Click **Devices** from the fly-out menu.
7. Click the **All** option.
8. Click the desired encoder, within the **Device List** window, to display the AMS interface.
9. Locate and make note of the IP address of the encoder, which can be found in the **IP Address** field.



### Configuring the Encoder Serial Port

The first step will be to configure the RS-232 port on the encoder to use IR. Only the **RS-232 2** port supports both RS-232 and IR. Therefore, this port must be used for IR. RS-232 port configuration is managed under the Serial page of the encoder web interface.

1. Enter the IP address of the encoder in the address bar of the web browser.

2. Enter the required login credentials. The default login is:

Username: admin

Password: Atlona

3. Click the **Login** button.

4. Click **Serial** in the top menu bar.

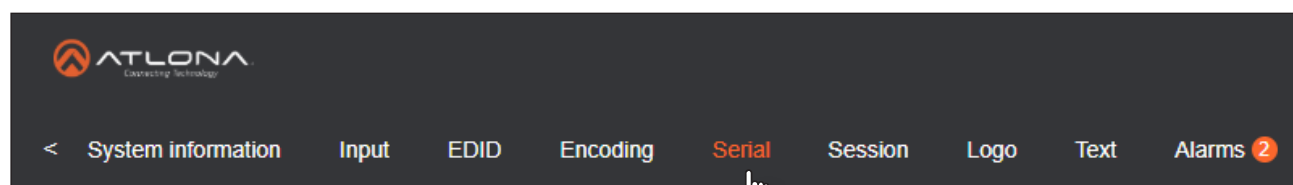

5. Locate the **Serial port configuration** window group. The **Name** field, within this window group, should read **serial\_port2**. Click the **Mode** drop-down list and select **Infrared**.

6. Click the **SAVE** button to commit changes.

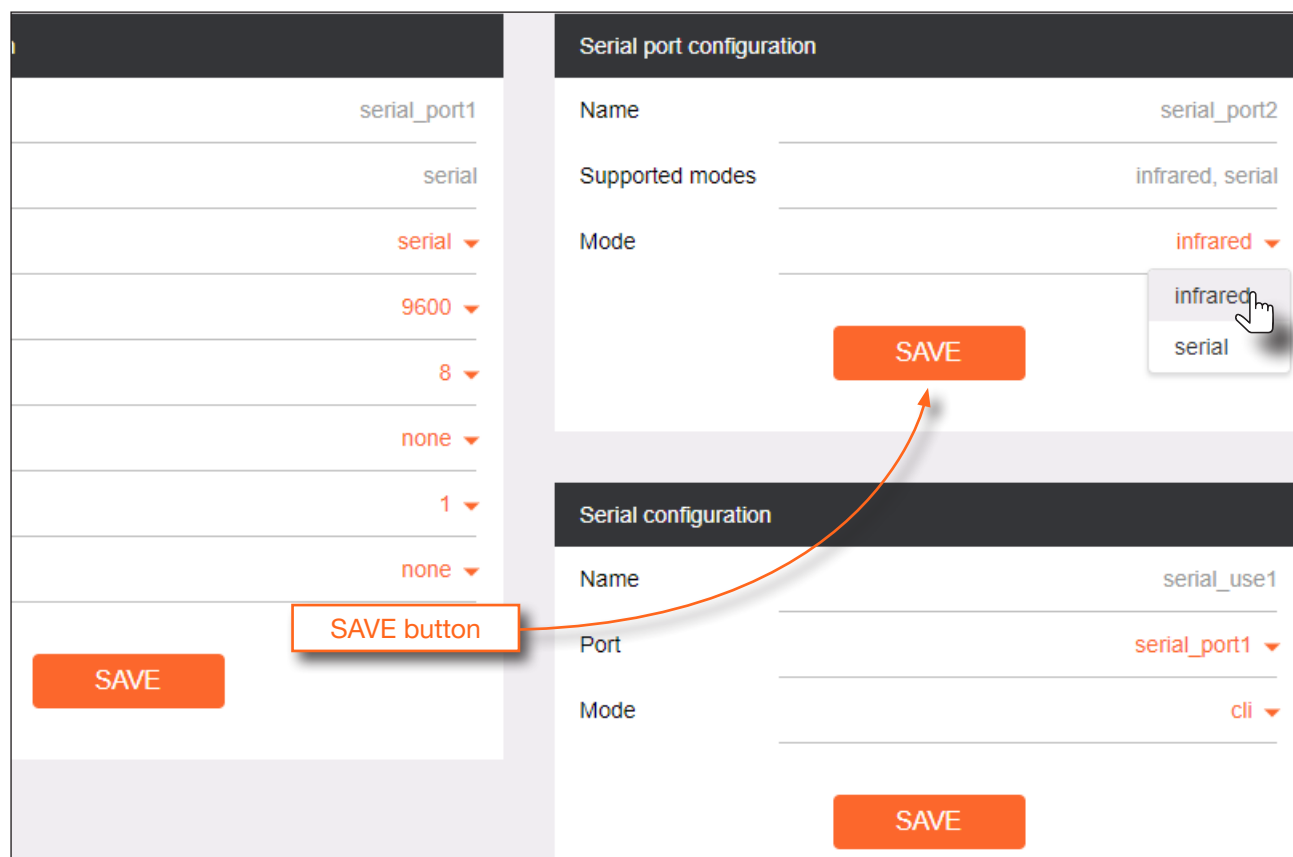

### Configuring the Encoder Session

The next step is to assign the IR control for Serial Port 2 to the desired Session.

1. Click **SESSION** in the top menu bar.

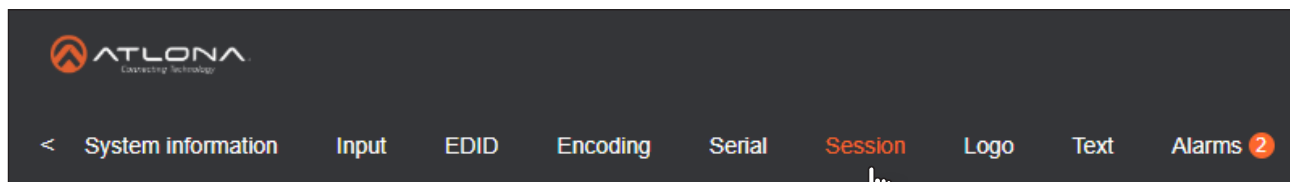

2. Locate the **Session 1** window group.



**NOTE:** **Session 2** can also be used with IR. However, in this example, **Session 1** will be configured.

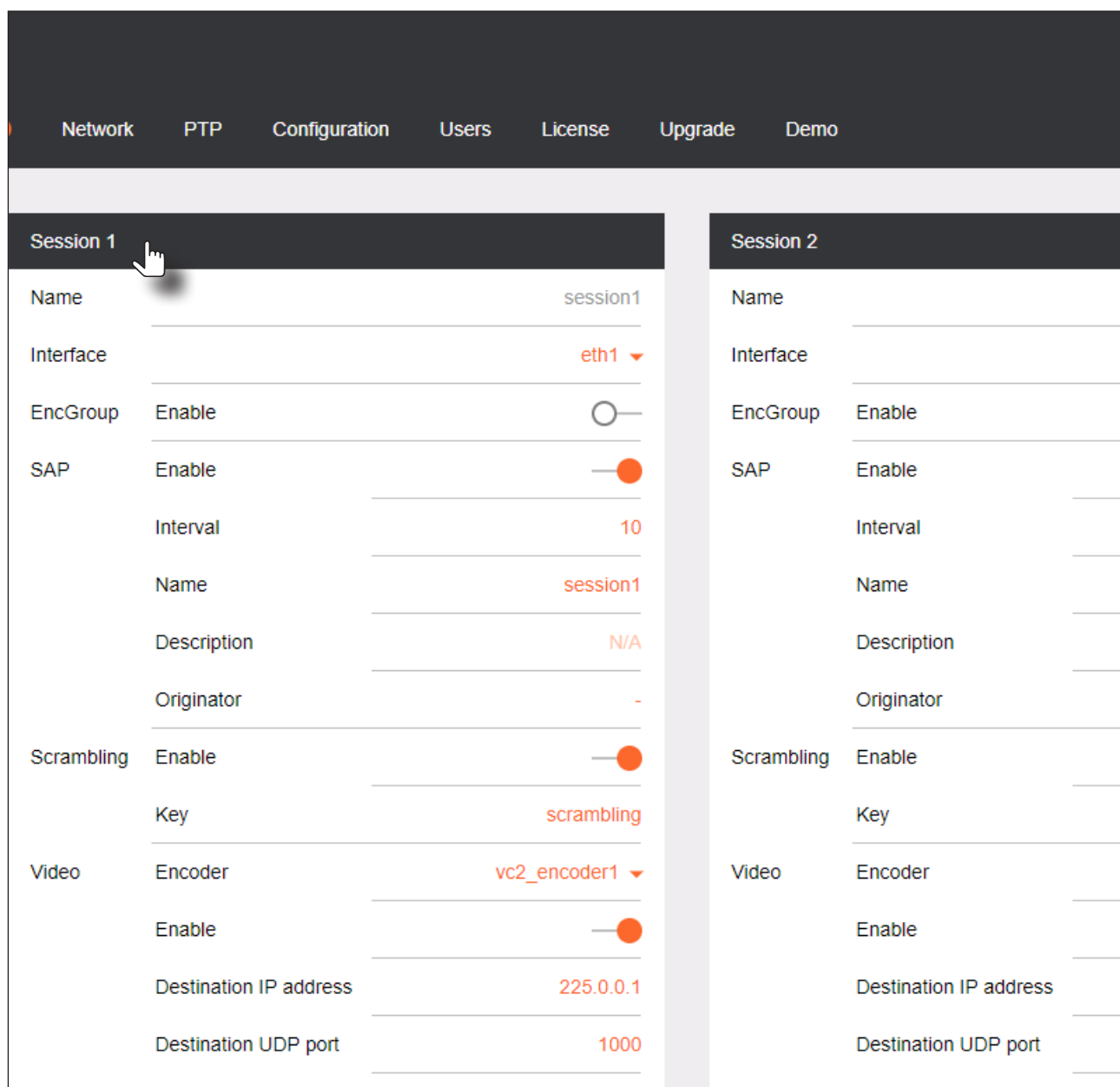

3. Scroll down and locate the **AUX** section.
4. Click the **Source** drop-down list and select **serial\_port2**.

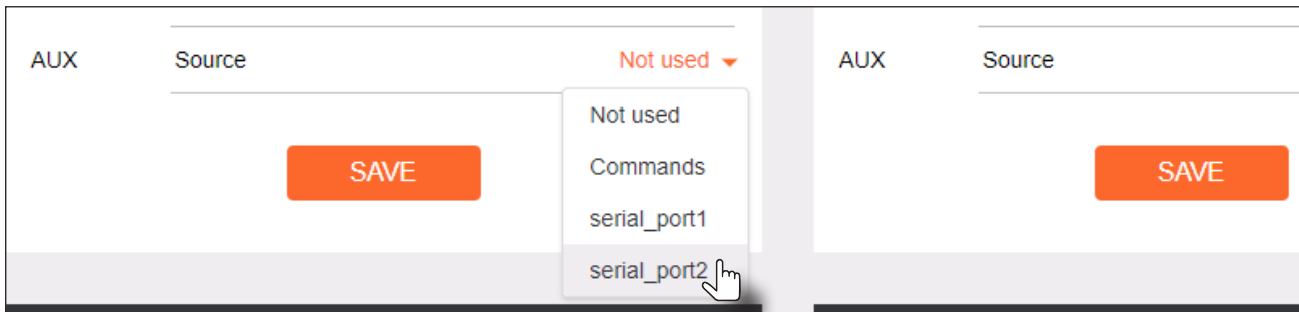

5. Enable the auxiliary (AUX) channel by clicking the **Enable** toggle switch. When the auxiliary channel is enabled, this toggle switch will be orange.
6. Enter the IP address of the *decoder* in the **Destination IP Address** field. This is the decoder to which the IR emitter is connected. In this example, the decoder IP address is 10.20.200.141.
7. Enter the port number in the **Destination UDP Port** field.
8. Click the **SAVE** button to commit changes.

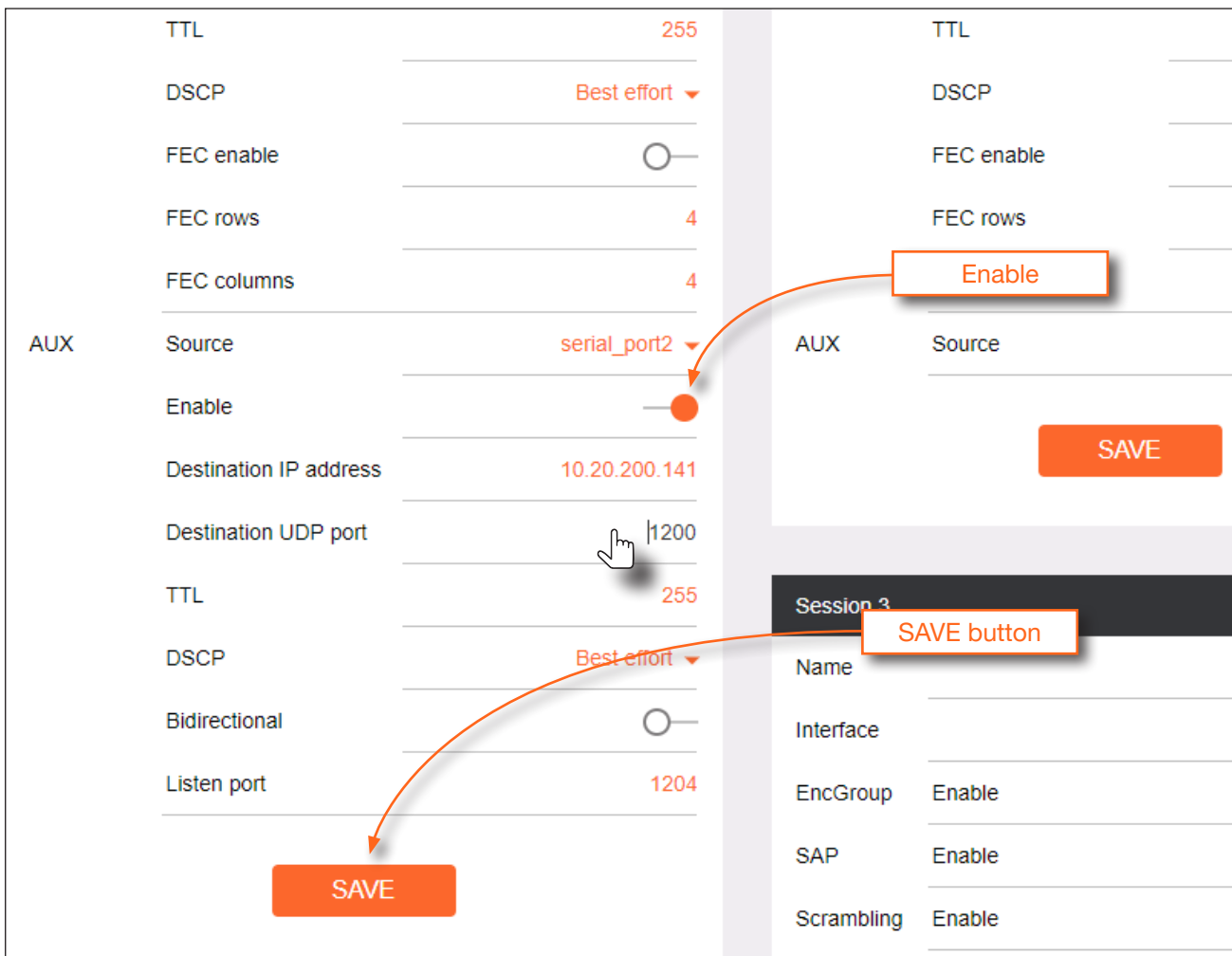

### Configuring the Decoder Serial Port

1. Select the desired decoder within the **AMS Device List** window and make note of the decoder IP address.
2. Enter the required login credentials. The default login is:

Username: admin  
 Password: Atlona

3. Click the **Login** button, then click **IP Input** in the top menu bar.

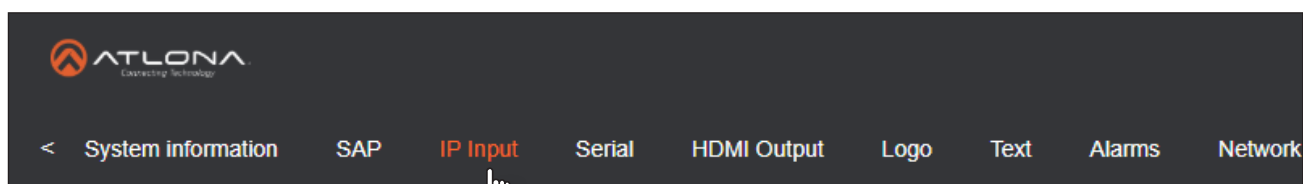

4. Scroll down to the **Input 5** window group.
5. Enable **Input 5** by clicking the **Enable** toggle switch. When enabled, this toggle switch will be orange.



**NOTE:** **Input 5** is dedicated to IR. Therefore, this input *must* be used in order for end-to-end IR to function properly.

6. Enter the port in the **Port** field. This port number must be the same port used by the encoder, and is the input of the decoder that will receive IR data.



**IMPORTANT:** Do not change the contents of the **Multicast Address** field. Unicast mode uses the IP address of the decoder for communication. Therefore, only the port number is required.

7. Click the **SAVE** button to commit changes.

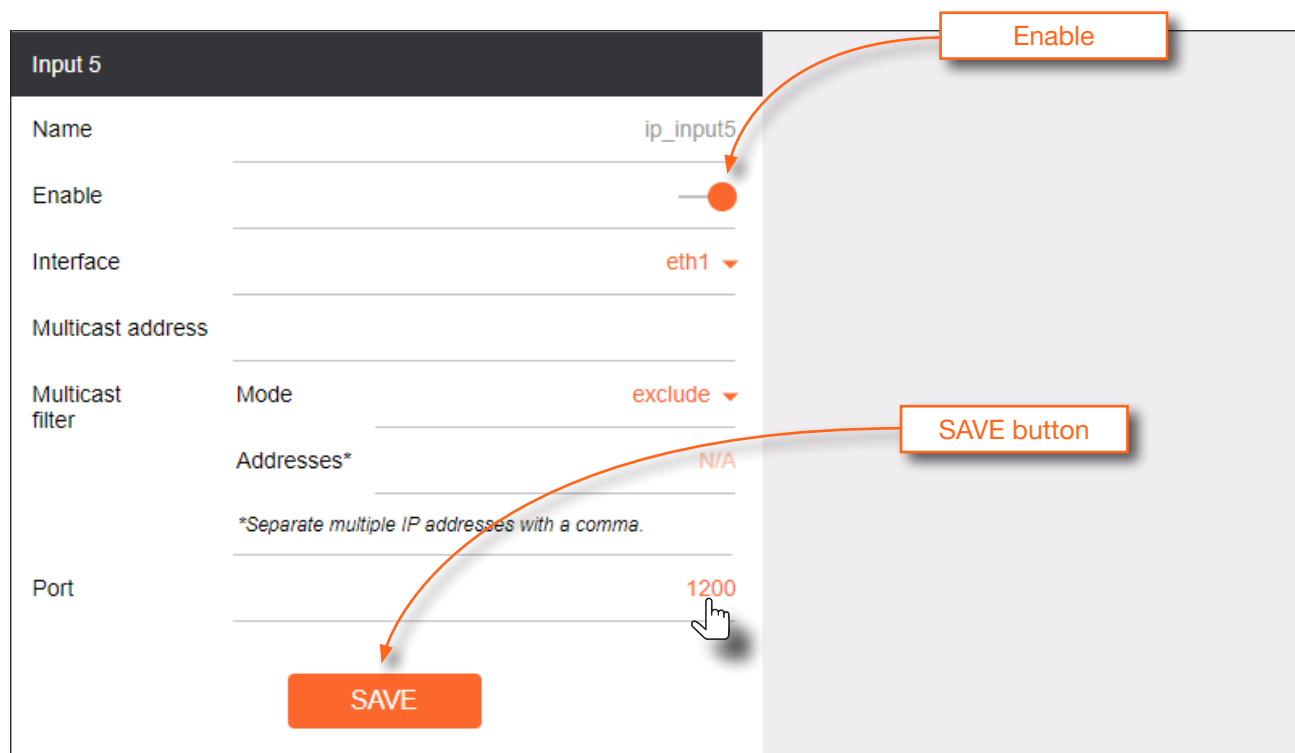



- Click **Serial** in the top menu bar.

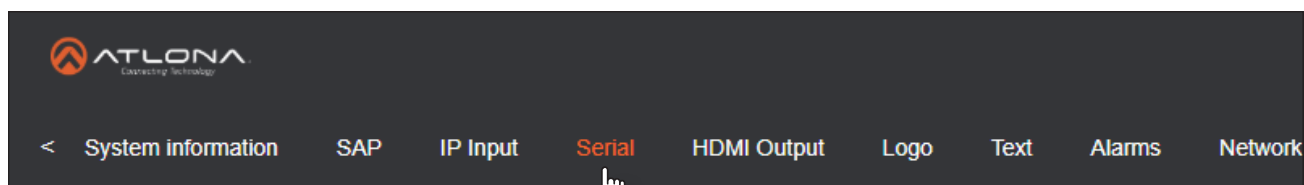

- Locate the **Serial port configuration** window group. The **Name** field, within this group, should read **serial\_port2**. Click the **Modes** drop-down list and select **Infrared**.

- Click the **SAVE** button to commit changes.

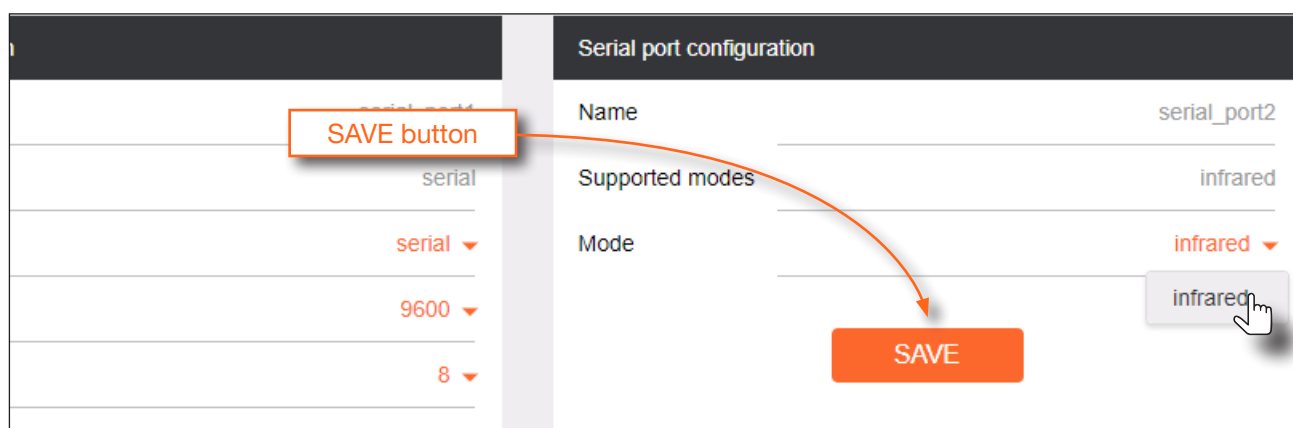

- Scroll down the page and locate the **Serial Configuration** window group. The **Name** field, within this group, should read **serial\_use2**.

- Click the **Port** drop-down list and select **serial\_port2**.

- Click the **Mode** drop-down list and select **output**.

- Click the **Input** drop-down list and select **ip\_input5**.

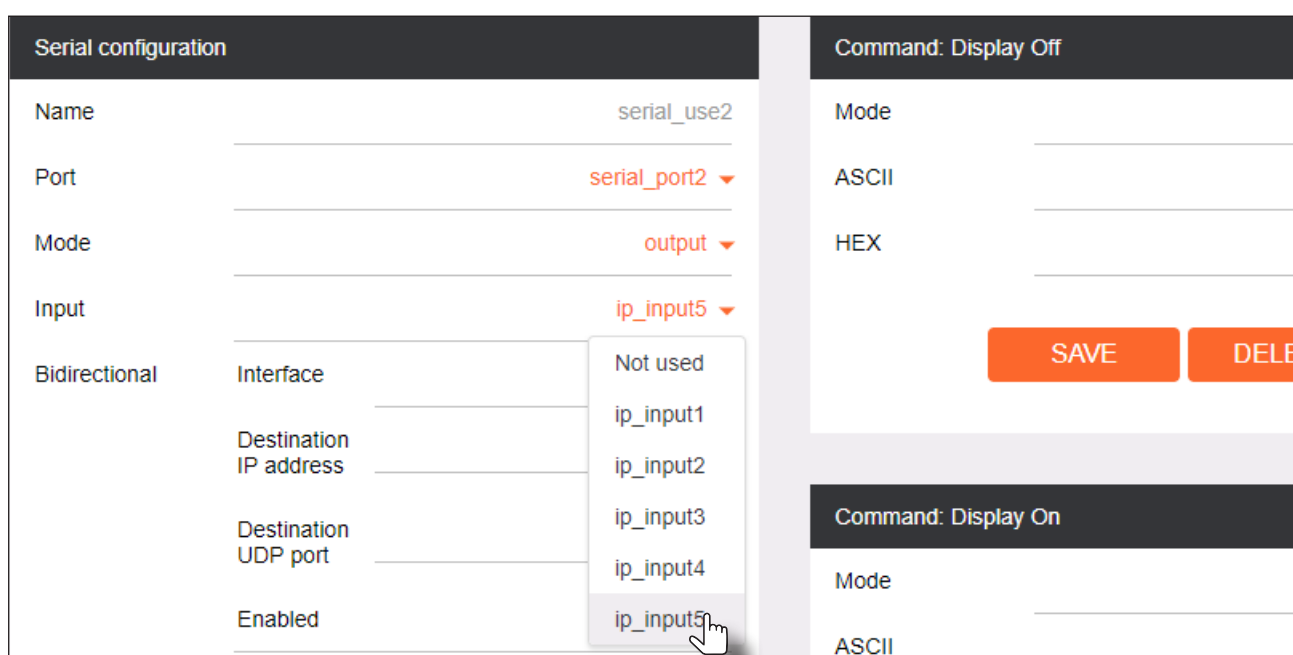

15. Click the **SAVE** button to commit changes.

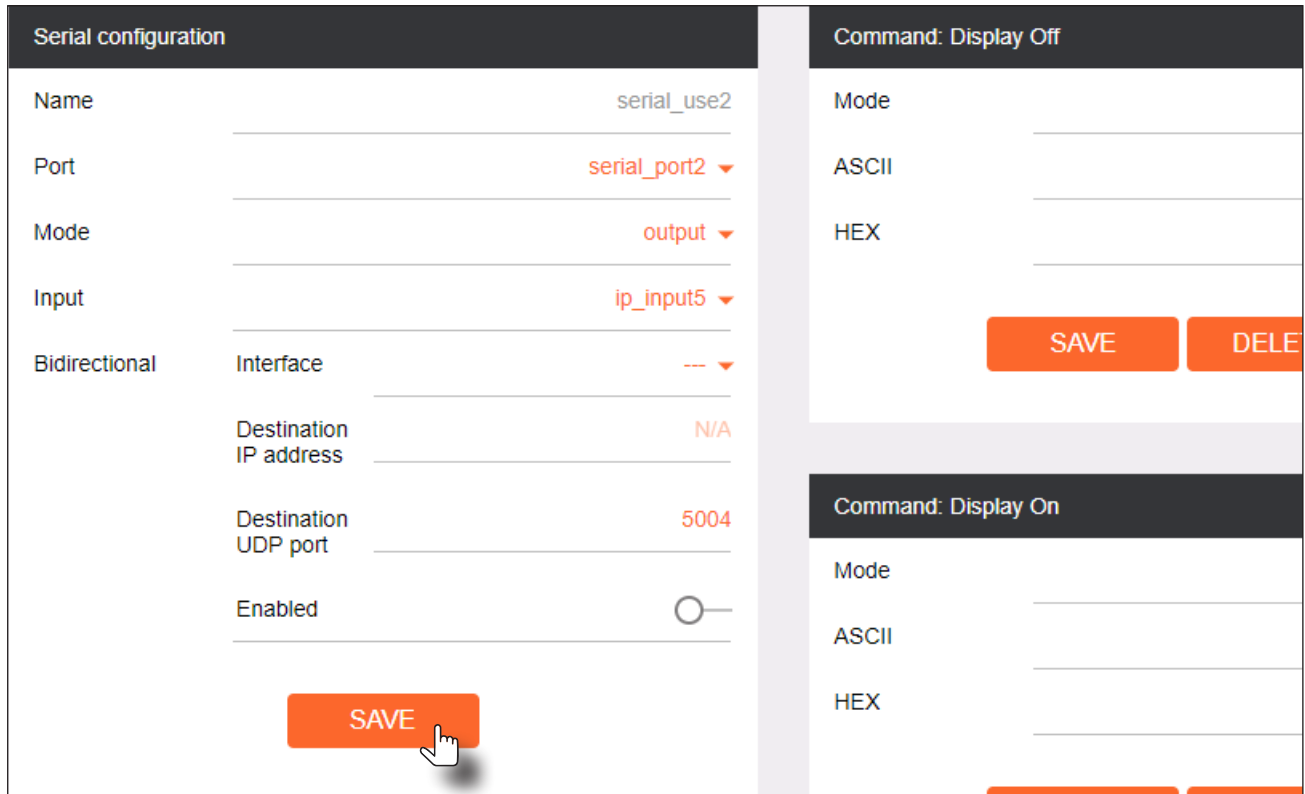

The screenshot displays a configuration interface for IR Control, divided into two main sections: Serial configuration and Command configuration.

**Serial configuration:**

- Name: serial\_use2
- Port: serial\_port2
- Mode: output
- Input: ip\_input5
- Bidirectional:
- Interface: ---
- Destination IP address: N/A
- Destination UDP port: 5004
- Enabled:

**Command configuration:**

- Command: Display Off
- Mode: \_\_\_\_\_
- ASCII: \_\_\_\_\_
- HEX: \_\_\_\_\_

Buttons: SAVE, DELETE

**Command configuration (second instance):**

- Command: Display On
- Mode: \_\_\_\_\_
- ASCII: \_\_\_\_\_
- HEX: \_\_\_\_\_

Buttons: SAVE, DELETE

A mouse cursor is shown clicking the **SAVE** button in the Serial configuration section.

### Testing IR Functionality

1. Point IR remote to at the IR Receiver, as shown in the diagram below.
2. The IR remote will now sent IR data to the decoder where it will be relayed to the display device.

 **IMPORTANT:** The IR lens of the emitter must be within 1 inch (2.54 centimeters) of the IR window on the display device. If this distance is exceeded, then IR functionality may fail.

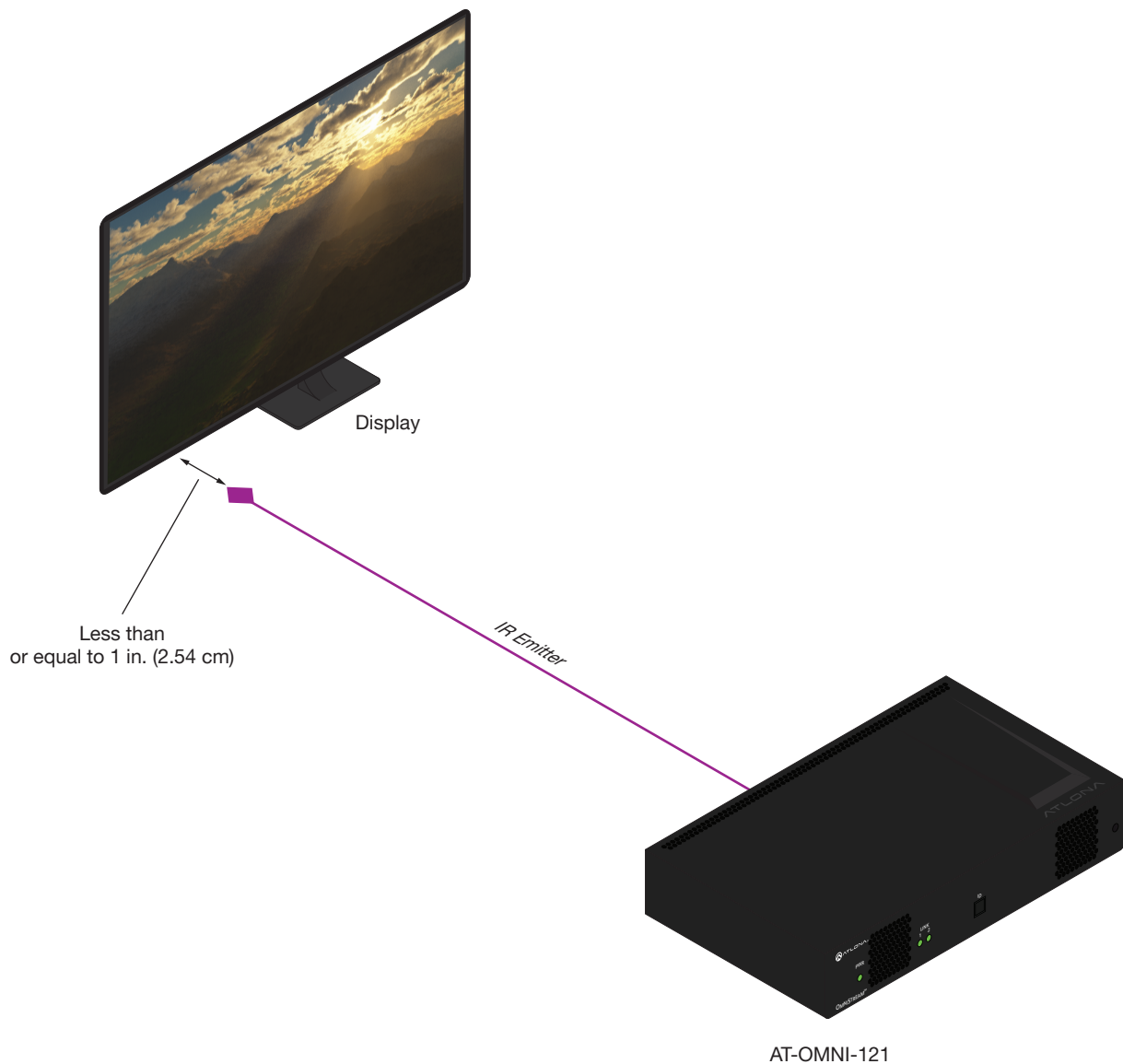

## Controlling the Display using a Control System

The following steps are similar to [Controlling the Display using the Display's IR Remote](#) (page 33), except that the control system wiring should be used, instead of an IR receiver, as shown below.

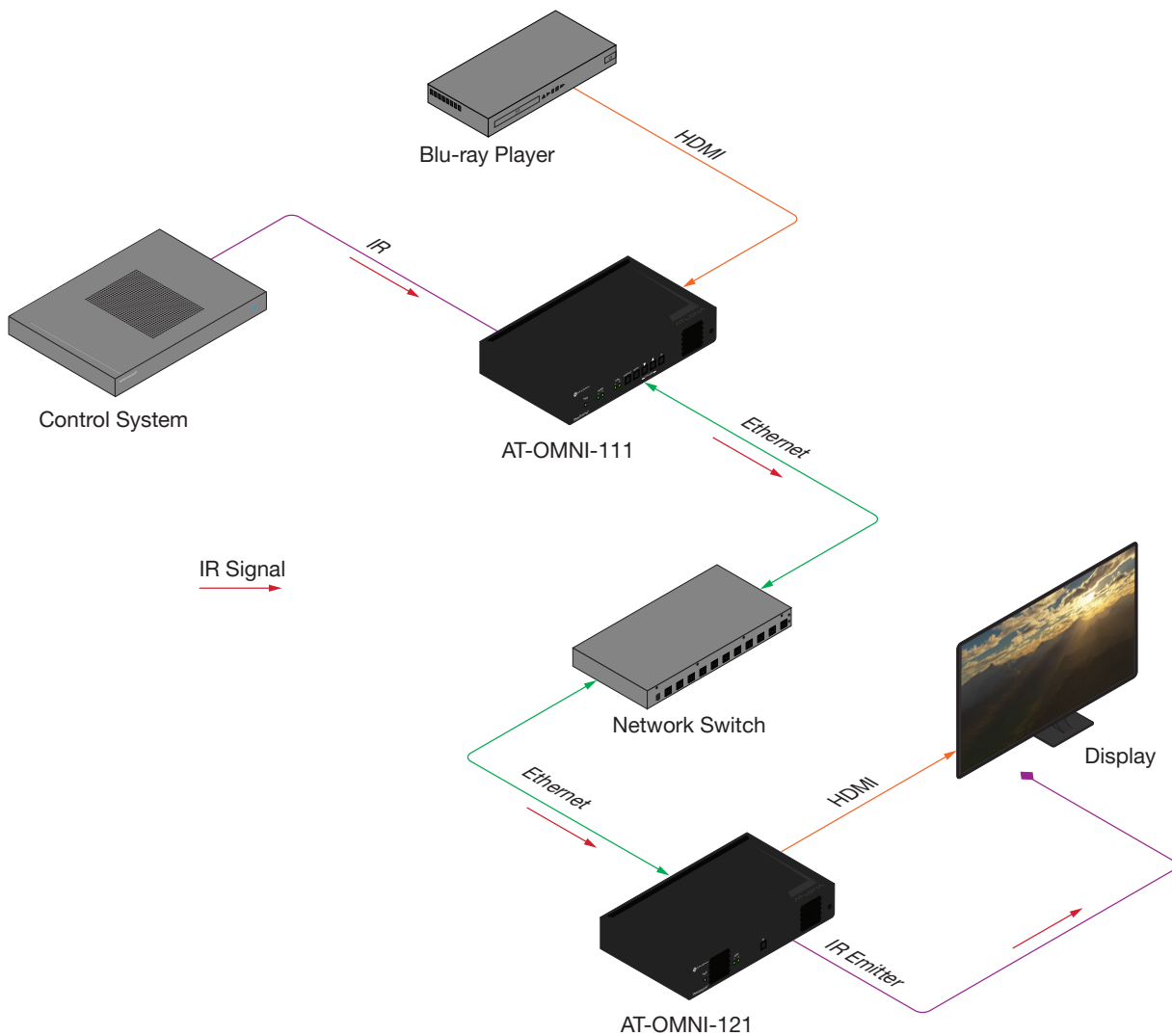

## Using the Virtual Matrix

1. Login to AMS. Refer to [Accessing Encoders in AMS \(page 16\)](#) if necessary.
2. Click the ☰ icon, in the upper-left corner of the AMS Dashboard.
3. Click on **Virtual Matrix**.

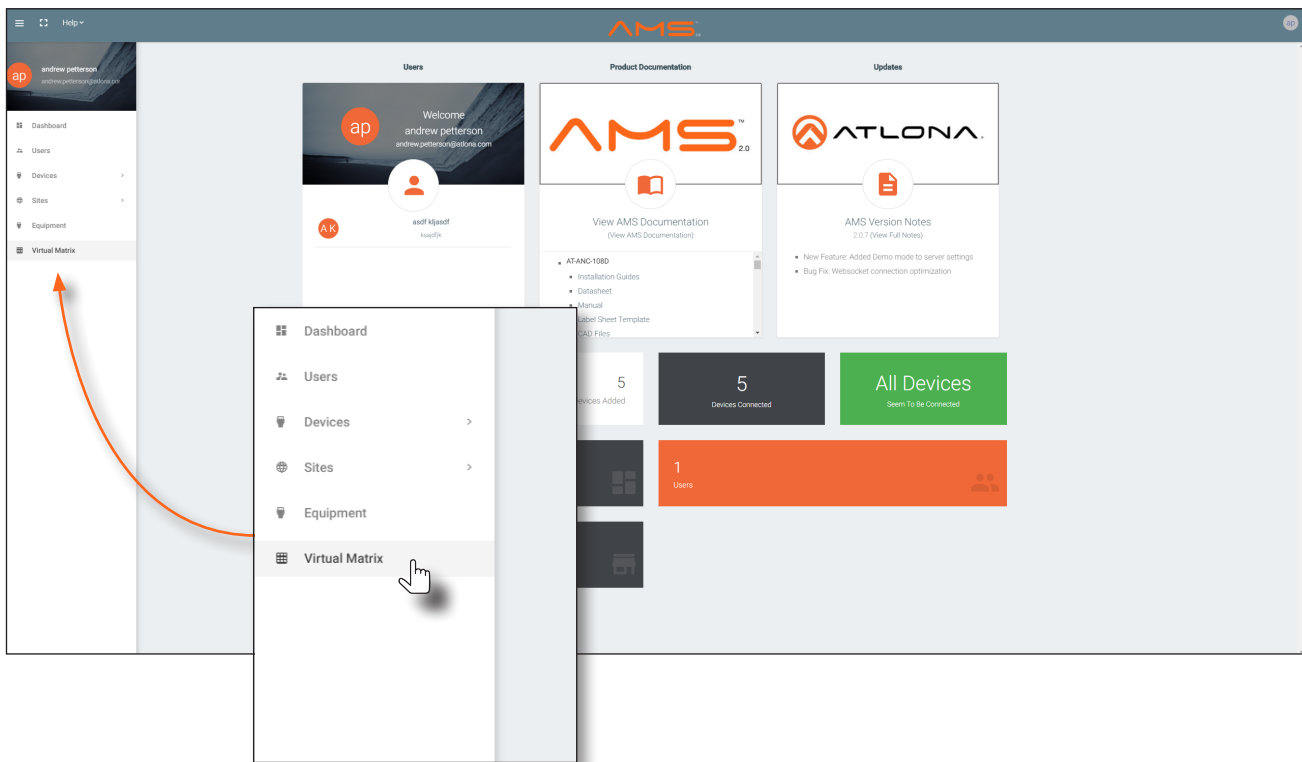

4. The **OmniStream Virtual Matrix** page will be displayed.

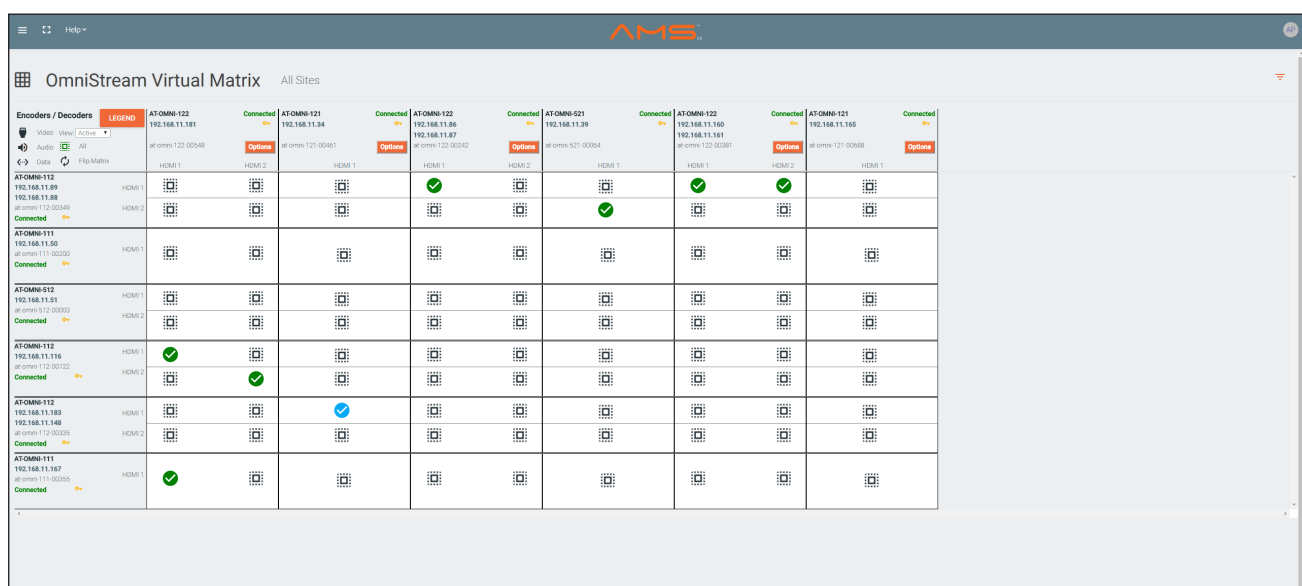

The screenshot shows the 'OmniStream Virtual Matrix' page. It displays a table with columns for different encoder models and rows for different sites. The table is titled 'All Sites' and includes a 'LEGEND' section for 'Encoders / Decoders'. The table shows connection status for various encoder models across different sites.

Encoders / Decoders	AT-OMNI-122 192.168.11.181	AT-OMNI-121 192.168.11.184	AT-OMNI-122 192.168.11.86 192.168.11.87	AT-OMNI-121 192.168.11.39	AT-OMNI-122 192.168.11.160 192.168.11.161	AT-OMNI-121 192.168.11.165
AT-OMNI-112 192.168.11.89	HEM1 1 [Matrix Icon]	HEM1 2 [Matrix Icon]	HEM1 1 [Matrix Icon]	HEM1 2 [Matrix Icon]	HEM1 1 [Matrix Icon]	HEM1 2 [Matrix Icon]
AT-OMNI-111 192.168.11.50	HEM1 1 [Matrix Icon]	HEM1 2 [Matrix Icon]	HEM1 1 [Matrix Icon]	HEM1 2 [Matrix Icon]	HEM1 1 [Matrix Icon]	HEM1 2 [Matrix Icon]
AT-OMNI-112 192.168.11.51	HEM1 1 [Matrix Icon]	HEM1 2 [Matrix Icon]	HEM1 1 [Matrix Icon]	HEM1 2 [Matrix Icon]	HEM1 1 [Matrix Icon]	HEM1 2 [Matrix Icon]
AT-OMNI-112 192.168.11.115	HEM1 1 [Matrix Icon]	HEM1 2 [Matrix Icon]	HEM1 1 [Matrix Icon]	HEM1 2 [Matrix Icon]	HEM1 1 [Matrix Icon]	HEM1 2 [Matrix Icon]
AT-OMNI-112 192.168.11.183 192.168.11.148	HEM1 1 [Matrix Icon]	HEM1 2 [Matrix Icon]	HEM1 1 [Matrix Icon]	HEM1 2 [Matrix Icon]	HEM1 1 [Matrix Icon]	HEM1 2 [Matrix Icon]
AT-OMNI-111 192.168.11.167	HEM1 1 [Matrix Icon]	HEM1 2 [Matrix Icon]	HEM1 1 [Matrix Icon]	HEM1 2 [Matrix Icon]	HEM1 1 [Matrix Icon]	HEM1 2 [Matrix Icon]

5. Click on the **View** drop-down list and select **Control**.



6. The Control screen will be displayed. In the Control screen, **HDMI** ports are replaced with control ports: **Port 1 In / Port 1 In** for encoders and **Port 1 Out / Port 2 Out** for decoders.

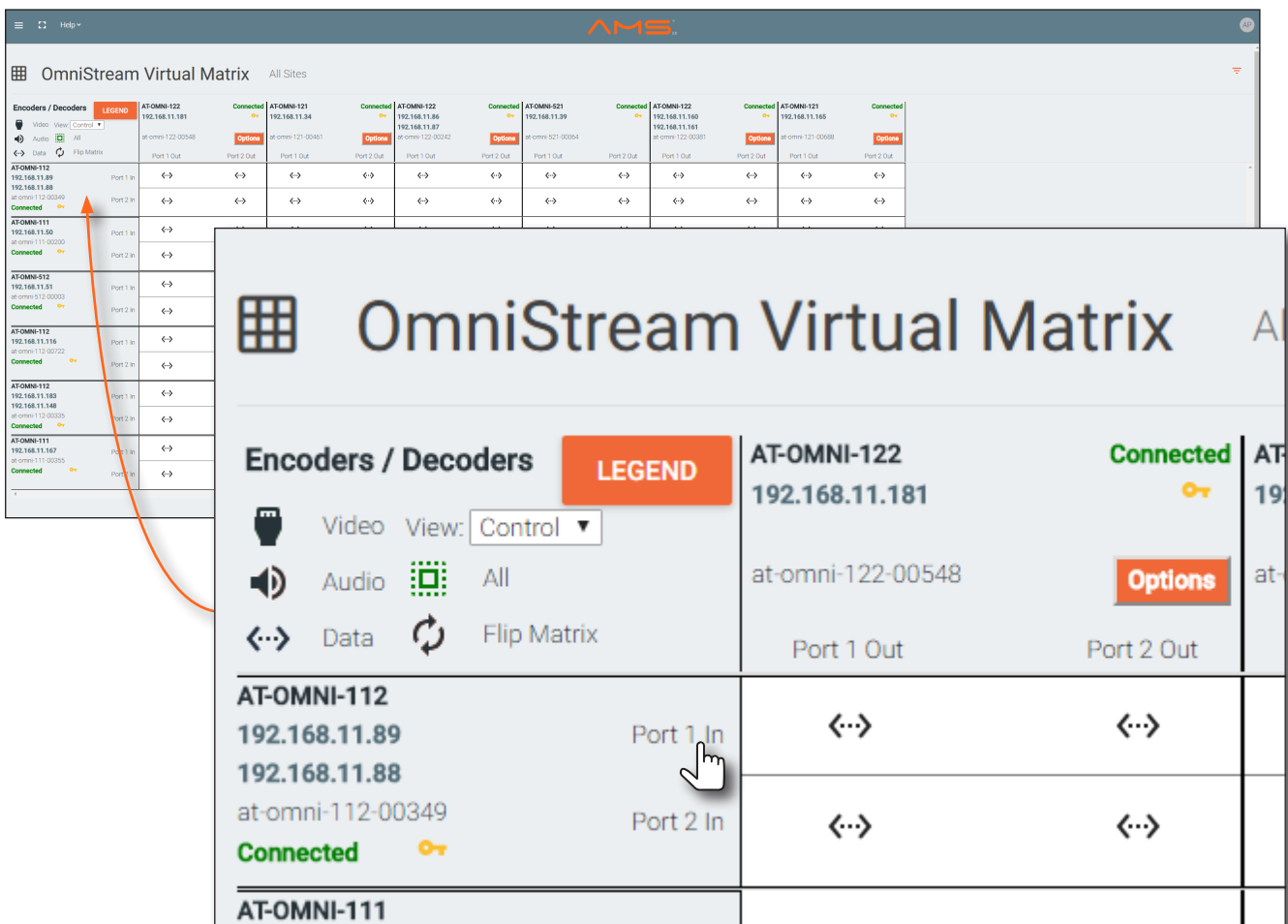

7. Click the **Options** button next to the desired decoder.

8. The **Crosspoint Options** dialog will be displayed.

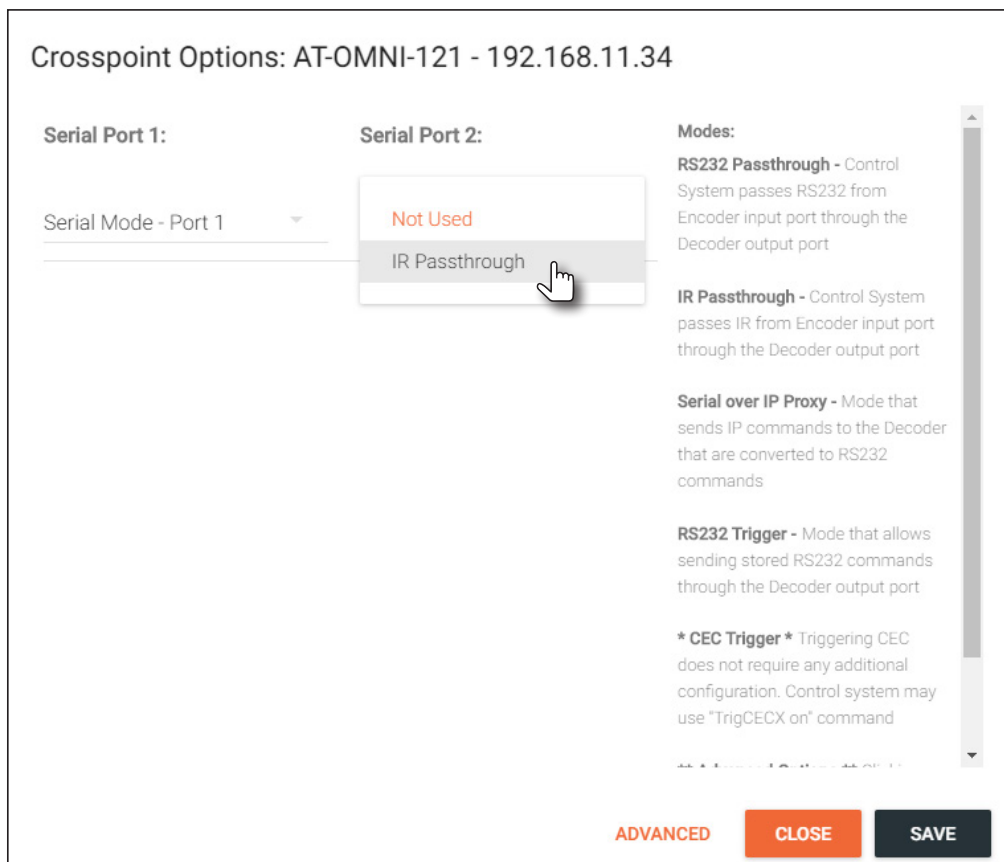

9. Click the **Serial Port 2** drop-down list and select **IR Passthrough**.

 **NOTE:** Only Serial Port 2 supports IR pass-through. The IR emitter or IR receiver must be connected to this port. Refer to [RS-232 Connections](#) (page 12) for wiring information.

10. Click **SAVE** to commit changes, then click **CLOSE** to dismiss the dialog and return to the Virtual Matrix page. To return to the Virtual Matrix page without saving changes, click the **CLOSE** button to dismiss the dialog.

## Advanced Operation

---

### Control Using RS-232

RS-232 data can be sent over IP using one of three methods: RS-232 pass-through, RS-232 triggering, and TCP proxy. Refer to the *OmniStream Single-Channel / Dual-Channel Networked AV Encoder User Manual* for information on configuring RS-232 triggering.



**NOTE:** When configuring RS-232, always make sure to configure the correct baud rate, data bits, parity bit, stop bits, and flow control settings, as required by the connected device. These settings can be changed in the **Serial Port** section, under the **SERIAL** menu.

#### RS-232 Pass-through

This method will pass-through RS-232 data, directly from a control system, to the sink device that is connected to the decoder.

1. Login to AMS. Refer to [Accessing Encoders in AMS \(page 16\)](#) if necessary.
2. Select the decoder in AMS.
3. Click **SERIAL** in the menu bar.
4. Configure the proper serial port settings under the **Serial Port** section for the connected device, then click the **SAVE** button.
5. Scroll down to the **Serial Configuration** section.
6. Click the **Mode** drop-down list and select the **Cli** option, then click the **SAVE** button.

#### Using TCP Proxy

This method is used to send IP commands directly to the decoder, which are then output over RS-232 to the display (sink) device.

1. Login to AMS. Refer to [Accessing Encoders in AMS \(page 16\)](#) if necessary.
2. Select the encoder in AMS.
3. Click **SERIAL** in the menu bar.
4. Click the **Mode** drop-down list and select **Serial**.
5. Configure the proper serial port settings under the **Serial Port** section for the connected device, then click the **SAVE** button.
6. Scroll down to the **Serial Configuration** section and select the desired serial port from the **Port** drop-down list. Note that for single-channel encoders, only **Serial Port 1** will be available.
7. Click the **Mode** drop-down list and select the **tcpproxy** option, then click the **SAVE** button.
8. Click **SESSION** in the menu bar.
9. Locate the **Control Serial** section, under the desired **Stream**, and click the **Source** drop-down list to select the serial port to which the control device is connected.
10. Click the **SAVE** button to commit all changes.



## Using the Virtual Matrix

1. Login to AMS. Refer to [Accessing Encoders in AMS \(page 16\)](#) if necessary.
2. Click the ☰ icon, in the upper-left corner of the AMS Dashboard.
3. Click on **Virtual Matrix**.

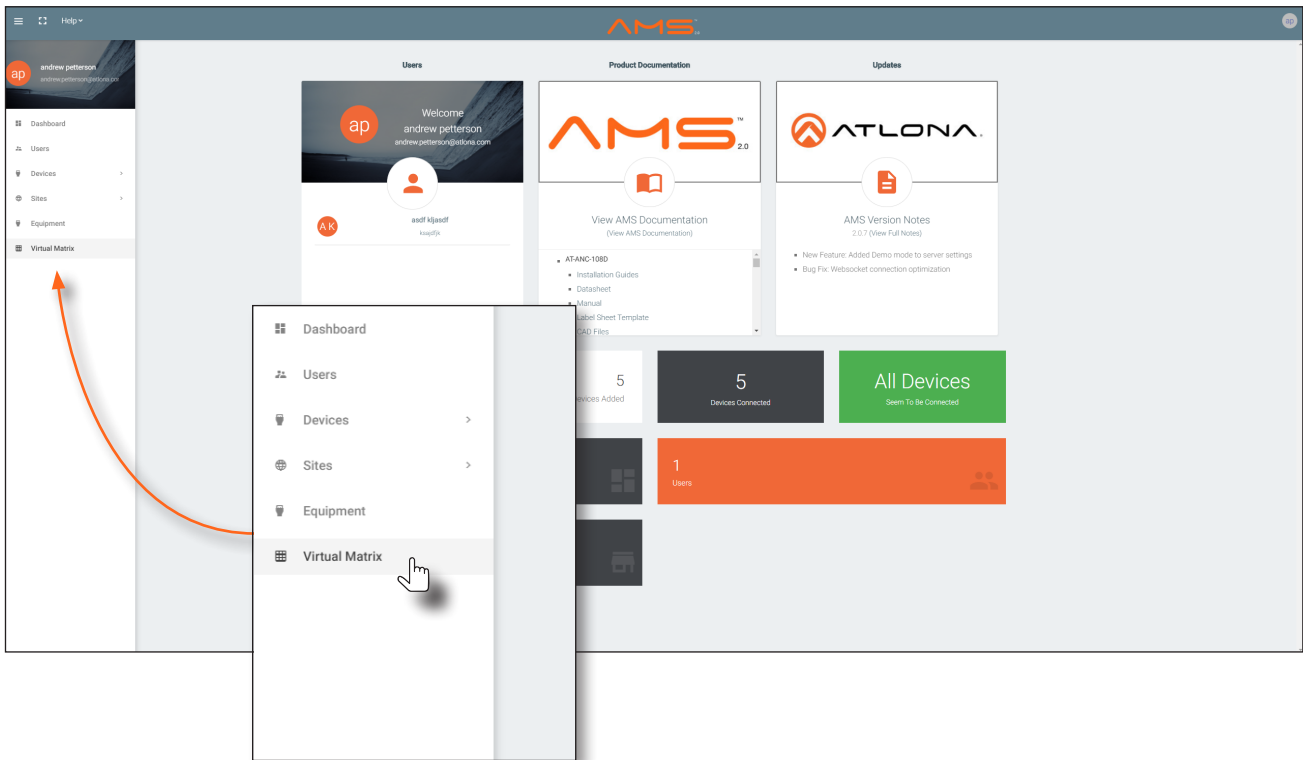

4. The **OmniStream Virtual Matrix** page will be displayed.



The screenshot shows the 'OmniStream Virtual Matrix' page. The page title is 'OmniStream Virtual Matrix' and it is for 'All Sites'. The page displays a grid of encoder connections. The columns represent different encoder models and their IP addresses, and the rows represent different encoder models and their IP addresses. The grid shows the connection status for each encoder model across different sites.

Encoders / Decoders	LEGEND	AT-OMNI-122 192.168.11.181 8f omni-122-03048	Connected	AT-OMNI-121 192.168.11.184 8f omni-121-00461	Connected	AT-OMNI-122 192.168.11.86 192.168.11.87 8f omni-122-00242	Connected	AT-OMNI-121 192.168.11.39 8f omni-121-00064	Connected	AT-OMNI-122 192.168.11.160 192.168.11.161 8f omni-122-00381	Connected	AT-OMNI-121 192.168.11.165 8f omni-121-00688	Connected
AT-OMNI-112 192.168.11.89 8f omni-112-00349	HEM1	Connected	HEM2	Connected	HEM1	Connected	HEM2	HEM1	HEM2	HEM1	HEM2	HEM1	HEM2
AT-OMNI-111 192.168.11.50 8f omni-111-00020	HEM1	Connected	HEM2	Connected	HEM1	Connected	HEM2	HEM1	HEM2	HEM1	HEM2	HEM1	HEM2
AT-OMNI-112 192.168.11.51 8f omni-112-00003	HEM1	Connected	HEM2	Connected	HEM1	Connected	HEM2	HEM1	HEM2	HEM1	HEM2	HEM1	HEM2
AT-OMNI-112 192.168.11.115 8f omni-112-00122	HEM1	Connected	HEM2	Connected	HEM1	Connected	HEM2	HEM1	HEM2	HEM1	HEM2	HEM1	HEM2
AT-OMNI-112 192.168.11.183 192.168.11.148 8f omni-112-00039	HEM1	Connected	HEM2	Connected	HEM1	Connected	HEM2	HEM1	HEM2	HEM1	HEM2	HEM1	HEM2
AT-OMNI-111 192.168.11.167 8f omni-111-00020	HEM1	Connected	HEM2	Connected	HEM1	Connected	HEM2	HEM1	HEM2	HEM1	HEM2	HEM1	HEM2

5. Click on the **View** drop-down list and select **Control**.

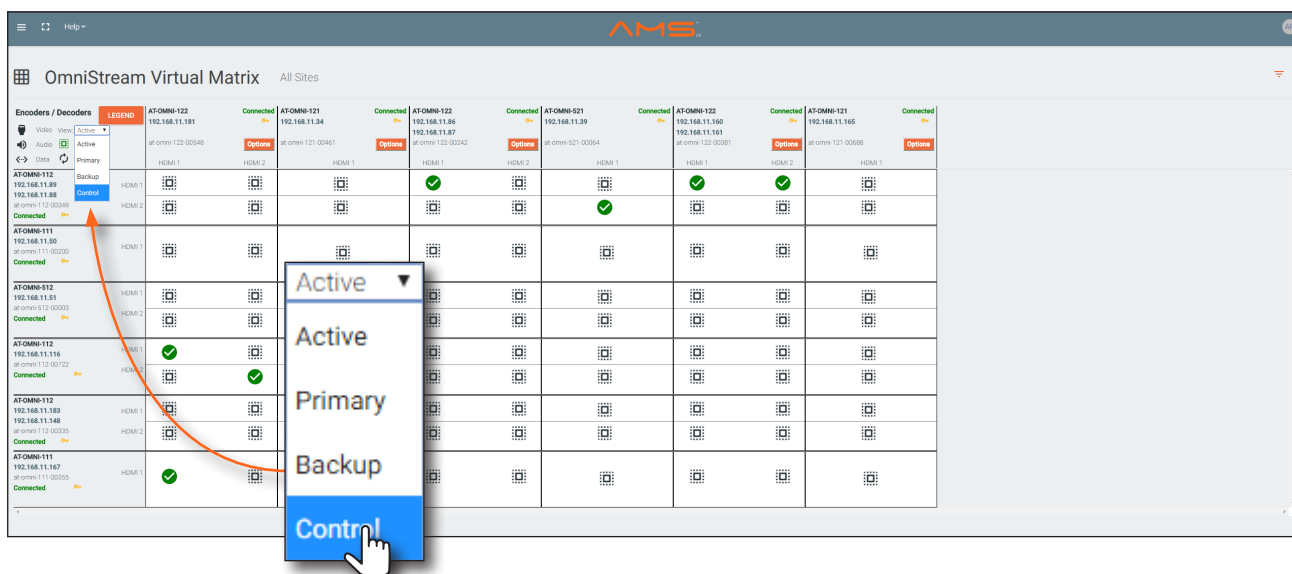

6. The Control screen will be displayed. In the Control screen, **HDMI** ports are replaced with control ports: **Port 1 In / Port 1 In** for encoders and **Port 1 Out / Port 2 Out** for decoders.

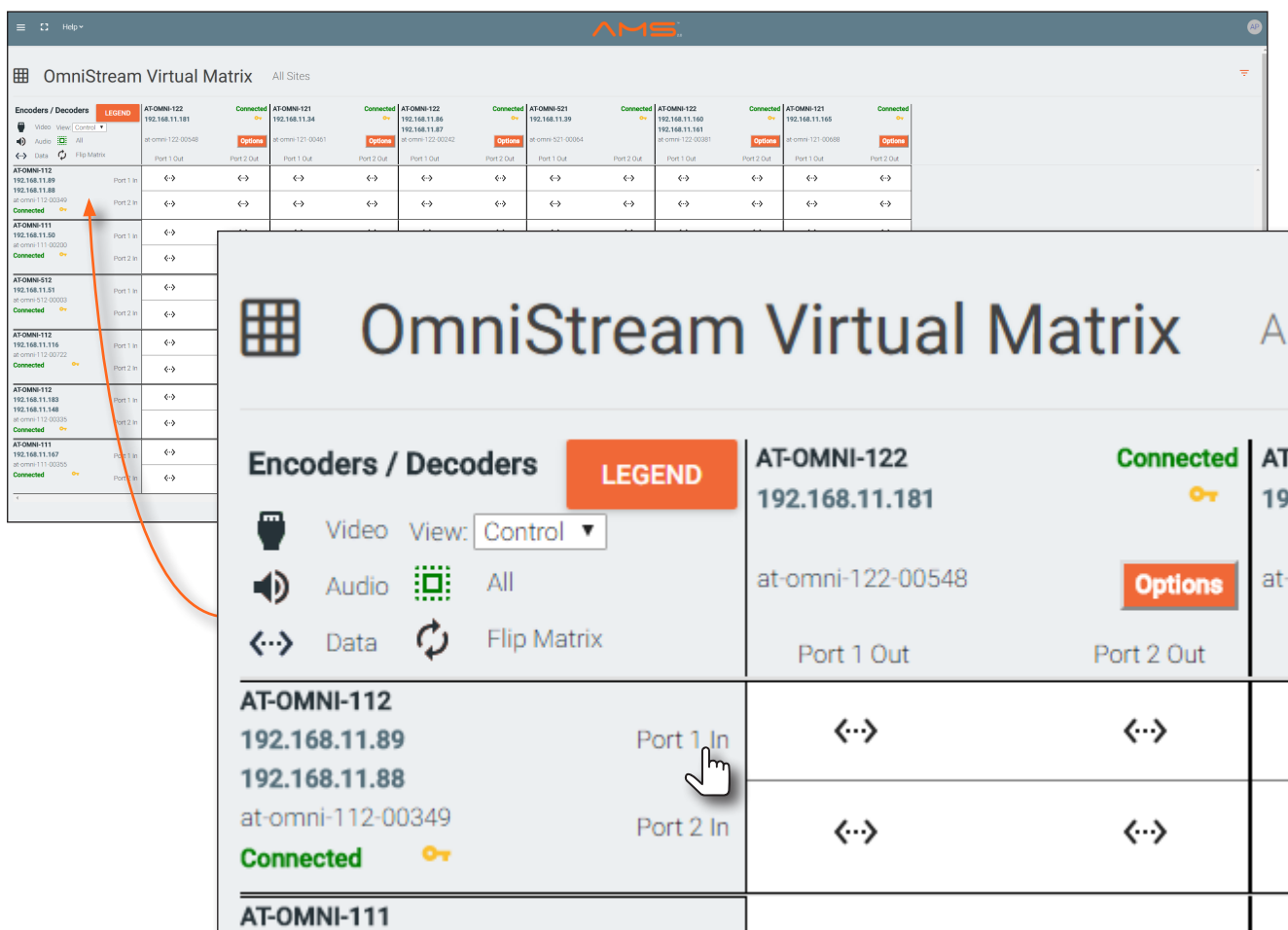

7. Click the **Options** button next to the desired decoder.

6. The **Crosspoint Options** dialog will be displayed.

**Crosspoint Options: AT-OMNI-121 - 192.168.11.34**

**Serial Port 1:**

Serial Mode - Port 1 ▼

**Serial Port 2:**

Serial Mode - Port 2 ▼

**Modes:**

**RS232 Passthrough** - Control System passes RS232 from Encoder input port through the Decoder output port

**IR Passthrough** - Control System passes IR from Encoder input port through the Decoder output port

**Serial over IP Proxy** - Mode that sends IP commands to the Decoder that are converted to RS232 commands

**RS232 Trigger** - Mode that allows sending stored RS232 commands through the Decoder output port

**\*CEC Trigger\*** Triggering CEC does not require any additional configuration. Control system may use "TrigCECX on" command

ADVANCED
CLOSE
SAVE

7. Click the **ADVANCED** button, near the bottom of the dialog. This will enable additional options in the Serial Port drop-down lists. In the **BASIC** mode, only **RS232 Passthrough** is available from drop-down list.

When the **ADVANCED** option is enabled, the following modes will be available. Refer to the list of modes, on the right-hand side of the dialog for a description of each.

The table below provides a summary of serial port control methods available for each encoder/decoder. Orange circles indicate that the feature is available on that port.

Control Method	AT-OMNI-111		AT-OMNI-112		AT-OMNI-121		AT-OMNI-122	
	Port 1	Port 2	Port 1	Port 2	Port 1	Port 2	Port 1	Port 2
RS-232 Pass-Through	●		●	●	●		●	●
IR Pass-Through		●		●		●		●
Serial over IP Proxy	●		●	●	●		●	●
RS-232 Trigger					●		●	●
RS-232 Encoder Buttons	●		●	●				

### RS232 Passthrough

This is the most basic option: the control system (DTE device) sends RS-232 commands from the encoder, downstream, to the decoder. The RS-232 commands are then received by a display (DCE device) or other sink device.

1. Select **RS232 Passthrough** from the **Serial Mode** drop-down list.

**Crosspoint Options: AT-OMNI-112 - 192.168.11.116**

<p><b>Serial Port 1:</b></p> <p>Serial Mode - Port 1          RS232 Passthrough</p>	<p><b>Serial Port 2:</b></p> <p>Serial Mode - Port 2          Not Used</p>	<p><b>Modes:</b></p> <p><b>RS232 Passthrough</b> - Control System passes RS232 from Encoder input port through the Decoder output port</p> <p><b>IR Passthrough</b> - Control System passes IR from Encoder input port through the Decoder output port</p> <p><b>Serial over IP Proxy</b> - Mode that sends IP commands to the Decoder that are converted to RS232 commands</p> <p><b>RS232 Encoder Buttons</b> - Mode that allows pressing encoder buttons to send stored RS232 commands through the Decoder output port</p> <p><b>RS232 Trigger</b> - Mode that allows sending stored RS232 commands through the Decoder output port</p>
---	--	--

Serial Mode changing, ensure that your connected decoder has the same mode.

**Display Off**

ASCII Command syntax

HEX Command syntax

**Display On**

ASCII Command syntax

HEX Command syntax

**Volume Down**

ASCII Command syntax

HEX Command syntax

**Volume Up**

ASCII Command syntax

HEX Command syntax

**BASIC**   **CLOSE**   **SAVE**

2. Click **SAVE** to commit changes, then click **CLOSE** to dismiss the dialog and return to the Virtual Matrix page. To return to the Virtual Matrix page without saving changes, click the **CLOSE** button to dismiss the dialog.

### Serial over IP Proxy (TCP Proxy)

This method is used to send IP commands directly to the decoder, which are then output over RS-232 to the display (sink) device.

1. Select **Serial over IP Proxy** from the **Serial Mode** drop-down list. If it is not listed, make sure that the **Advanced** button is clicked, at the bottom of the dialog.
2. Scroll down to the **Serial Port** settings and provide the required settings. These settings must match the port settings on the display (sink) device.
  - a. Click the **Interface** drop-down list to select the interface (Ethernet port) that will be used to transmit the data.
  - b. Enter the port number in the **TCP Proxy Port** field. This number can be in the range from 0 to 65535.
  - c. Specify the baud rate, data bit, parity, stop bit, and flow control in the appropriate fields.

**Crosspoint Options: AT-OMNI-112 - 192.168.11.116**

**Serial Port 1:**

Interface	any
TCP Proxy Port	10000
Baud Rate	115200
Data Bit	7
Parity	None
Stop	2
Flow Control	None

BASIC
CLOSE
SAVE

3. Click **SAVE** to commit changes, then click **CLOSE** to dismiss the dialog and return to the Virtual Matrix page. To return to the Virtual Matrix page without saving changes, click the **CLOSE** button to dismiss the dialog.

## 802.1X Authentication

802.1X is a server-based port authentication which restricts unauthorized (rogue) clients from connecting to a Local Area Network through a public port. In its simplest form, 802.1X usually involves three parties: supplicant (client device), authenticator (Ethernet switch or WAP), and an authentication server. Before the device is permitted on the network, port communication is restricted to Extensible Authentication Protocol over LAN (EAPOL) traffic. If the device passes the authentication process, the authentication server notifies the switch, allowing the client to access the LAN. The illustration below shows the basic architecture.

**WARNING:** Connecting an 802.1X-enabled encoder to a network without an active or operational authentication server, will result in an encoder that does not function until the expected message is returned from a RADIUS server. If it is unclear as to whether the network uses 802.1X authentication, consult the IT administrator for assistance.

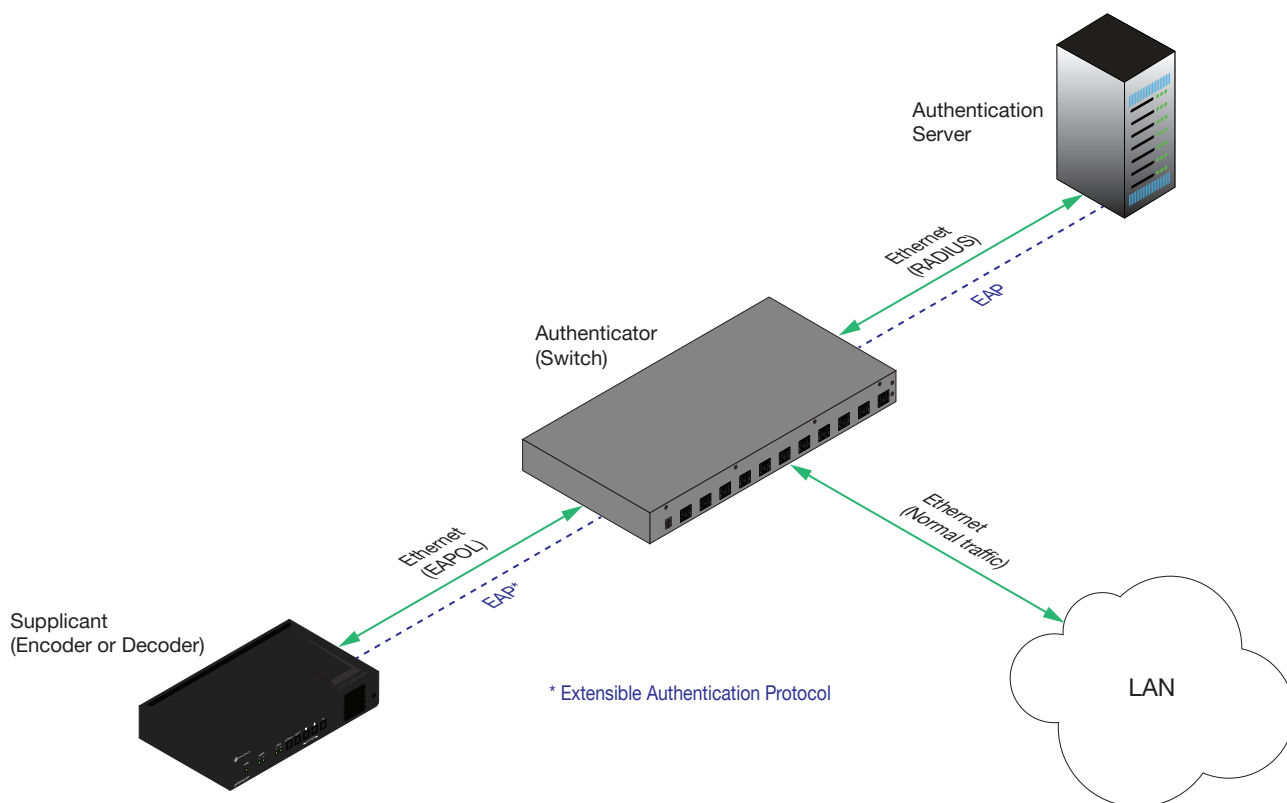

Three options are available on both the OmniStream encoder and decoder.

Protocol	Description
none	802.1X protocol disabled
PEAP/MSCHAPv2	Protected EAP; requires basic credentials in addition to a CA (certificate authority) certificate.
EAP-TLS	EAP Transport Layer Security; requires a client certificate, client private key, and CA (certificate authority) certificate.

1. Login to AMS. Refer to [Accessing Encoders in AMS \(page 16\)](#), if necessary.
2. Click **Devices** > **All** and select the desired encoder from the **Device List**.
3. Click **NETWORK** in the menu bar.



**NOTE:** If using dual-channel encoders, both **Network 1 (eth1)** and **Network 2 (eth2)** will need to be set up, depending upon the system requirements.

4. Click the **SHOW ADVANCED** button to expand the options under both **Network** window groups.
5. Click the **802.1x Mode** drop-down list, at the bottom of the page, and select the desired authentication method. In the example below, **PEAP/MSCHAPv2** is selected.

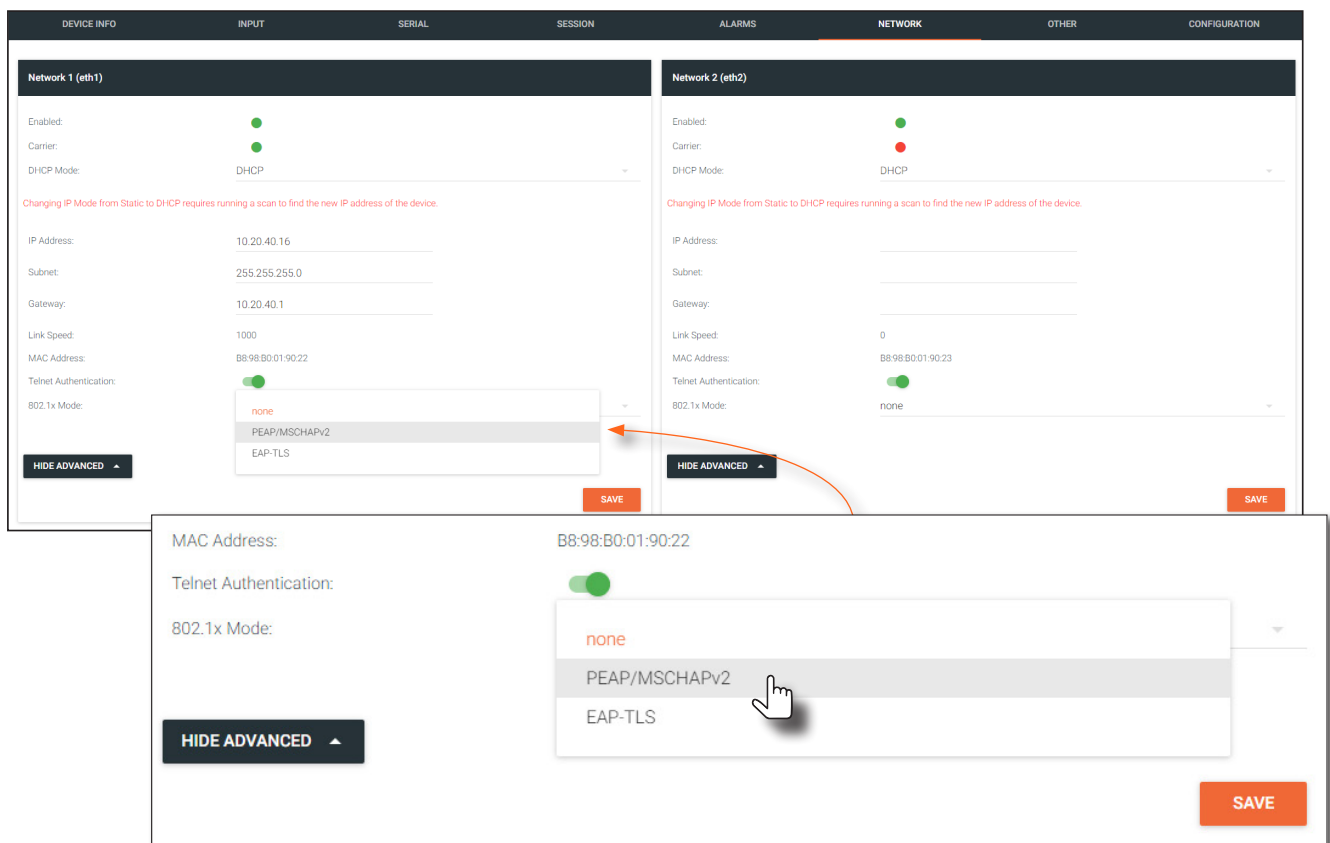

The screenshot displays the configuration page for two network interfaces: Network 1 (eth1) and Network 2 (eth2). Both are currently set to DHCP mode. The 802.1x Mode dropdown menu is open, showing three options: 'none', 'PEAP/MSCHAPv2', and 'EAP-TLS'. A red arrow points to the 'PEAP/MSCHAPv2' option. Below the main configuration area, a detailed view of the 802.1x Mode settings is shown, with 'PEAP/MSCHAPv2' selected. The MAC Address is B8:98:B0:01:90:22 and Telnet Authentication is enabled.

6. Once a method is selected, the required fields for that method will be displayed. Enter the required information in each field. For the **PEAP/MSCHAPv2** option, the fields are described as follows:

- **Identity**  
Enter the identity of the authentication server in this field. PEAP uses this field to identify the correct authentication server which will process the credentials. For example, if foo@authserv.com is entered, then this identifies AUTHSERV as the RADIUS (authentication) server.
- **CA certificate**  
Click the **Browse...** button to select the certification authority (CA) certificate. To remove a certificate, click the **Remove** button.
- **Username**  
Enter the username in this field
- **Password**  
Enter the password in this field.

MAC Address: B8:98:B0:01:90:22

Telnet Authentication:

802.1x Mode: PEAP/MSCHAPv2

Identity:

Password:

CA certificate:

**HIDE ADVANCED** ▲

**SAVE**

7. Click **SAVE** to commit changes.
8. Refer to the table below for a list of available authentication methods. An orange dot indicates that this field will be displayed as part of the method.

Authentication Method	Identity	Password	CA Certificate	CA Certificate	Client Private Certificate
PEAP/MSCHAPv2	●	●	●		
EAP-TLS			●	●	●

9. 802.1X authentication configuration is complete. If desired, click the **HIDE ADVANCED** button to collapse the options under both **Network** window groups.



## AES67 Audio

AES67 audio is a standard for high-performance audio streaming over IP, providing several features such as synchronization, media clock identification, and connection management. AES67 does not support bitstream/compressed audio formats, such as Dolby® Digital, and others. Source audio must be transmitted as LPCM up to eight channels at 192 kHz / 24-bit.

1. Login to AMS. Refer to [Accessing Encoders in AMS \(page 16\)](#), if necessary.
2. Click **Devices** > **All** and select the desired encoder from the **Device List**.
3. Click **SESSION** in the menu bar.
4. Locate the **Audio** section, under the desired **Stream**, and click the **Enable AES67** toggle switch to enable this feature. When enabled, the toggle switch will be green.

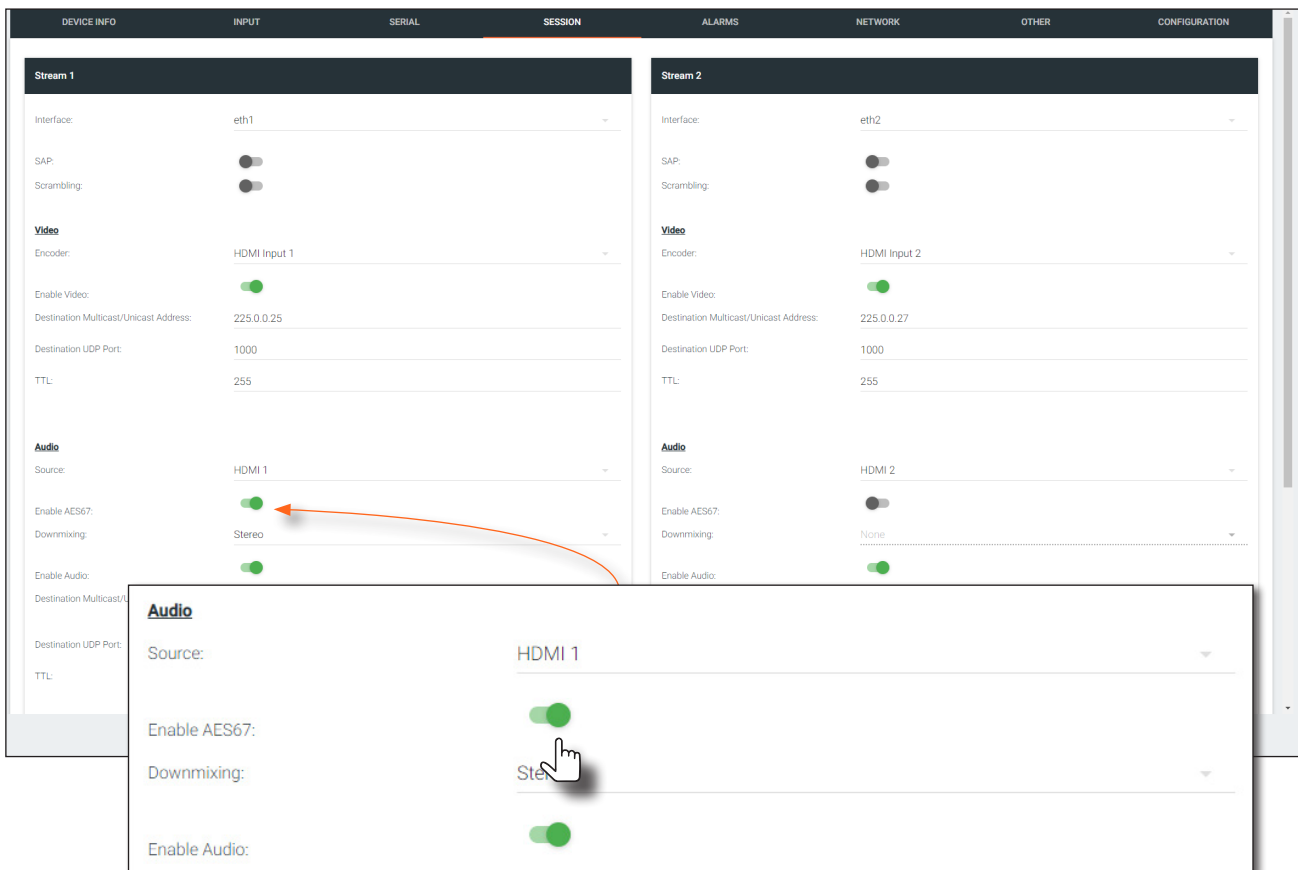

5. Select the type of downmixing from the **Downmixing** drop-down list, if desired. Available options are: **None**, **Mono**, or **Stereo**.
6. Click the **SAVE** button within the **Stream** window group.
7. Go to the decoder interface and click **OTHER** in the menu bar.
8. Click **SAP** in near the upper-left corner of the AMS screen.
9. Click the **Enable** toggle switch to enable SAP. When enabled, the toggle switch will be green. Refer to the *OmniStream Single-Channel / Dual Channel A/V Decoder User Manual*, if necessary. If the decoder, Dante controller, or DSP is to receive AES67 audio, this step is *required*.
10. Click the **SAVE** button on the **SAP** page.

## EDID Management

OmniStream encoders provide EDID management for each input. The encoder can be assigned one of several included EDID presets or can be assigned a custom EDID. Raw EDID data can be copied from displays or other sink devices, that are connected to OmniStream decoders.

### Selecting an EDID Preset

1. Login to AMS. Refer to [Accessing Encoders in AMS \(page 16\)](#), if necessary.
2. Click **INPUT** in the menu bar.
3. Click the **EDID** drop-down list, within the desired **HDMI Input** window group, and select the EDID.

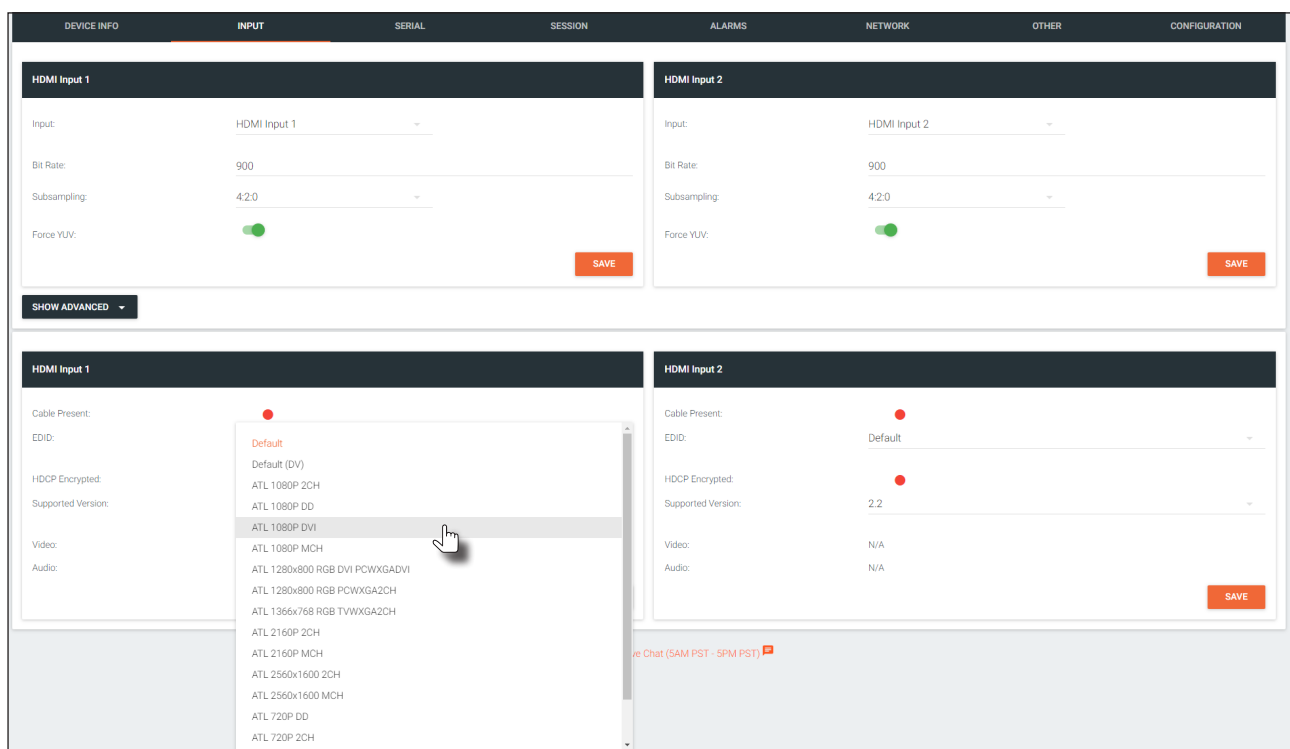

4. Click the **SAVE** button to commit changes.

### Using a Custom EDID

Encoders can be assigned a custom EDID. The raw EDID data must be in hexadecimal format. Commas or spaces can be included as delimiters to separate each hexadecimal value.

1. Login to AMS. Refer to [Accessing Encoders in AMS \(page 16\)](#), if necessary.
2. Click **INPUT** in the menu bar.
3. Click the **EDID** drop-down list.
4. Scroll down to the bottom of the list and select **+ Add Custom EDID**.
5. Enter the name of the EDID in the **EDID Name** field. Spaces and special character are valid entries. Use a descriptive name for this field.

### Add Custom EDID

EDID Name  
3840 x 2160 YUV 60 Hz

---

Raw EDID  
|

Raw EDID

---

CANCEL
SUBMIT

6. Enter the EDID data in the **Raw EDID** field. EDID data can be copy and pasted from an EDID editor and must be in hexadecimal format. Commas or spaces can be included as delimiters to separate each hexadecimal value.
7. Click the **SUBMIT** button to commit changes or click **CANCEL** to abort the addition of a custom EDID. Once a custom EDID is created, it will be added to the drop-down list and can be selected without re-entering the information.

The following tables provide a list of which EDID to use with each video mode. Note that the available EDID selections will depend upon the current video mode. Refer to [Setting the Video Mode \(page 69\)](#) for more information.

### Common

EDID	2CH LPCM	MCH LPCM	DTS	Dolby	Dolby Digital*	DTS-HD MA †	Dolby True HD*
1080P 2CH	Yes	No	No	No	No	No	No
1080P DD	No	No	Yes	Yes	No	No	No
1080P MCH	No	Yes	Yes	Yes	Yes	Yes	Yes
ATL VR (2160x1200)	Yes	No	No	No	No	No	No

### PC application mode only

EDID	2CH LPCM	MCH LPCM	DTS	Dolby	Dolby Digital*	DTS-HD MA †	Dolby True HD*
Default	Yes	No	Yes	Yes	Yes	Yes	Yes
1080P DVI	No	No	No	No	No	No	No
1280x800 RGB DVI PCWXGADVI	No	No	No	No	No	No	No
1280x800 RGB PCWXGA2CH	Yes	No	No	No	No	No	No
1366x768 RGB TVWXGA2CH	Yes	No	No	No	No	No	No
2160P 2CH	Yes	No	No	No	No	No	No
2160P MCH	No	Yes	Yes	Yes	Yes	No	No
2560x1600 2CH	Yes	No	No	No	No	No	No
2560x1600 MCH	No	Yes	Yes	Yes	Yes	No	No

## Video mode only

EDID	2CH LPCM	MCH LPCM	DTS	Dolby	Dolby Digital*	DTS-HD MA †	Dolby True HD*
Default -Video Mode	No	Yes	Yes	Yes	Yes	Yes	Yes
Default - Video Mode (No HDR)	No	Yes	Yes	Yes	Yes	Yes	Yes
4K60 MCH	No	Yes	Yes	Yes	Yes	Yes	Yes
4K60 PCM-MCH	No	Yes	No	No	No	No	No
460 LPCM 2CH	Yes	No	Yes	Yes	Yes	Yes	Yes
720P DD	No	No	Yes	Yes	No	No	No
720P 2CH	Yes	No	No	No	No	No	No

\* Dolby Atmos® is carried with either Dolby Digital Plus or Dolby True HD audio streams.

† DTS:X is carried with DTS-HD MA audio streams.

## Copying an EDID from the Display

In order to allow the source device to send all AV formats that are supported by the display device, the EDID from the decoder must be copied to the encoder. Access to a decoder will be required.

1. Login to AMS and access the desired decoder. Refer to [Accessing Encoders in AMS \(page 16\)](#) except instead of clicking on an encoder, click on a decoder (AT-OMNI-121 or AT-OMNI-122).
2. Make sure the display, where the EDID will be fetched, is connected to the decoder. Select the desired decoder from within AMS.
3. Click **HDMI OUTPUT** in the menu bar.

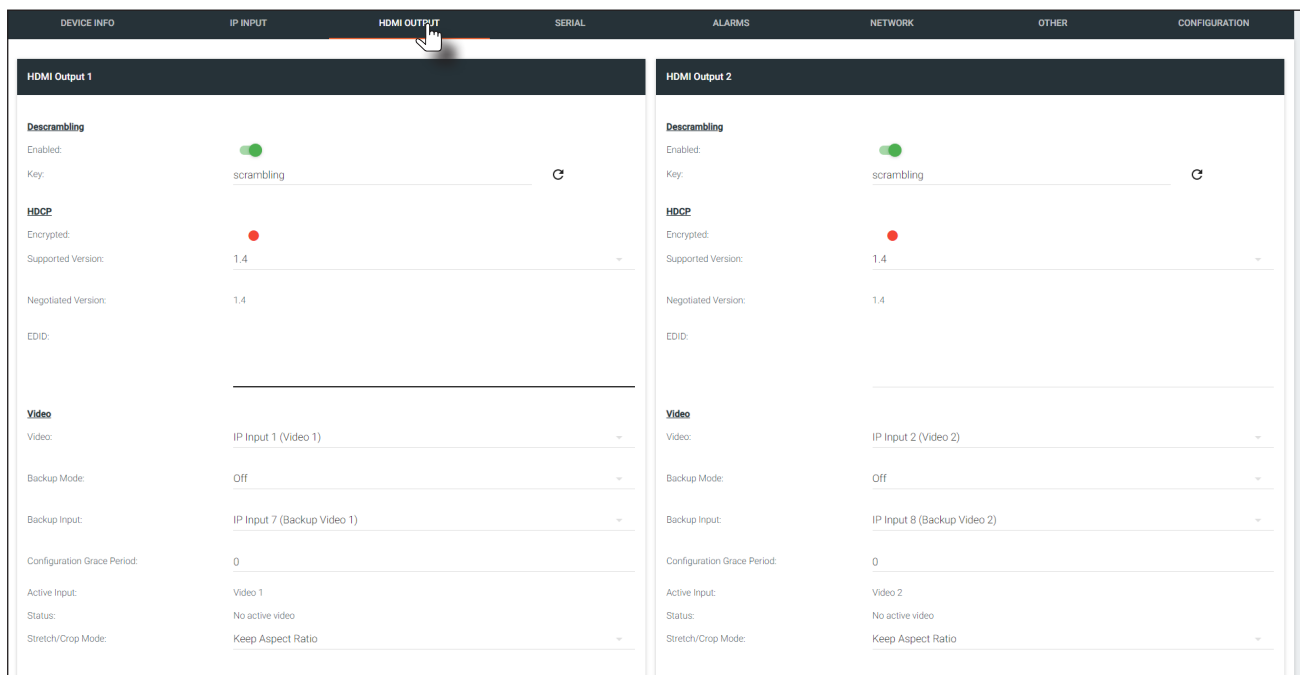

4. Locate the **EDID** section. This is the EDID of the display which is connected to the decoder. Click and select the data in this field, then press [CTRL]+[C] to copy the data.

HDMI Output 1

**Descrambling**

Enabled:

Key: scrambling ↻

---

**HDCP**

Encrypted:

Supported Version: 1.4

Negotiated Version: 1.4

EDID:

```
00 FF FF FF FF FF 00 4C 2D CB 0B 00 00 00 0D 18 01 03 80 47 2B 78 2A D6 91 A7 55 4E A0 25 0C
50 54 BF EF 80 71 4F B1 00 81 C0 81 80 95 00 A9 C0 B3 00 01 01 56 5E 00 A0 A0 A0 29 50 30 20 35 00
C4 8E 21 00 00 1A 02 2A 80 18 71 28 2D 40 58 2C 45 00 C4 8E 21 00 00 1E 00 00 00 FD 00 18 4B 1B 5A
19 00 0A 20 20 20 20 20 20 00 00 00 FC 00 53 33 32 44 38 35 30 0A 20 20 20 20 01 18 02 03 1C F1
48 90 04 1F 13 03 12 20 22 23 09 07 07 83 01 00 00 66 03 0C 00 10 00 80 02 2A 80 18 71 28 2D 40 58
2C 45 00 C4 8E 21 00 00 1E 02 2A 80 D0 72 38 2D 40 10 2C 45 80 C4 8E 21 00 00 1E 01 1D 00 72 51 D0
1E 20 6E 28 55 00 C4 8E 21 00 00 1E 01 1D 00 BC 52 D0 1E 20 B8 28 55 40 C4 8E 21 00 00 1E 00 00 00
00 00 00 00 00 00 00 00 00 00 00 00 00 00 00 00 00 00 00 00 00 00 00 00 00 00 00 00 00 00 A2
```

**Video**

5. Select the desired encoder, within AMS.
6. Click **INPUT** in the menu bar.
7. Click the **EDID** drop-down list, in the desired **HDMI Input** window group.
8. Scroll down to the bottom of the list and select **+ Add Custom EDID**.

Input: HDMI Input 1

Bit Rate: 900

Subsampling: 4:2:2

Force YUV:

SAVE

Input: HDMI Input 2

Bit Rate: 900

Subsampling: 4:2:2

Force YUV:

SAVE

**SHOW ADVANCED**

**HDMI Input 1**

Cable Present:

EDID: Default (DV)

HDCP Encrypted:

Supported Version:

Video:

Audio:

**HDMI Input 2**

Cable Present:

EDID: Default

HDCP Encrypted:

Supported Version:

Video:

Audio:

SAVE



## Encoder Grouping

Grouping encoders allows a group of encoders to feed a single decoder, simultaneously. The stream will be displayed by the decoder using either manual or automatic input-selection, based on the presence of a source signal.

1. Login to AMS. Refer to [Accessing Encoders in AMS \(page 16\)](#), if necessary.
2. Click **SESSION** in the menu bar.
3. Click the **SHOW ADVANCED** button to expand options for the desired **Stream**.
4. Locate **Encoder Groups** and enter a name for the group in the **Group Name** field. The default group names for **Stream 1** and **Stream 2** are **session1** and **session2**, respectively.

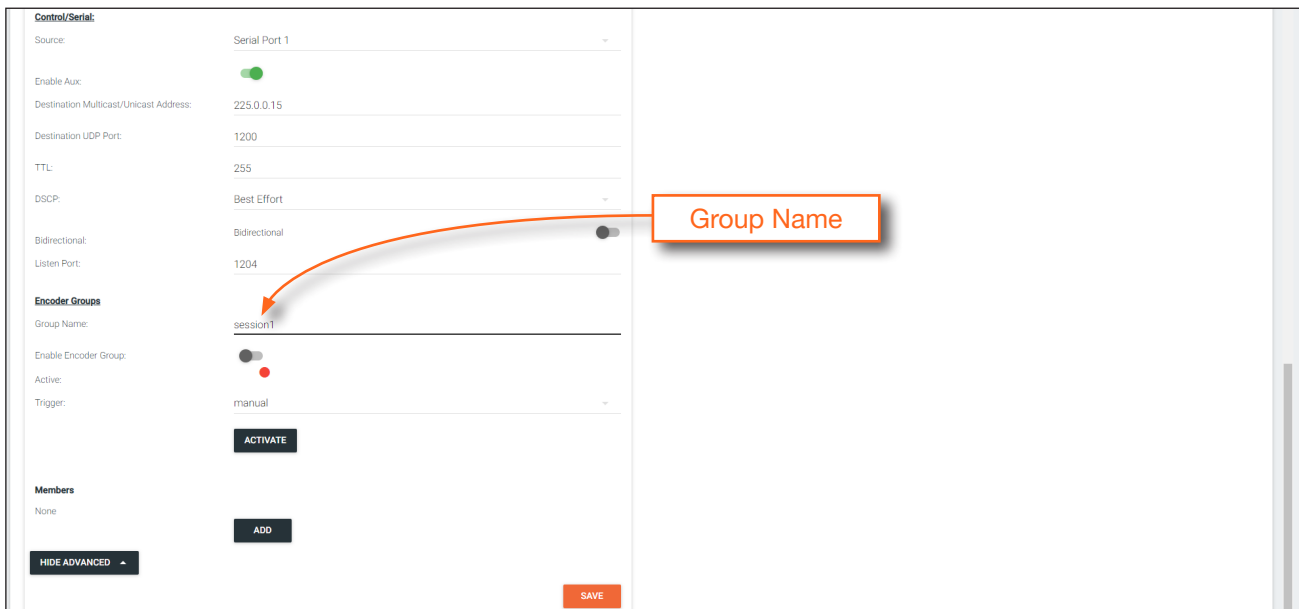

5. Under **Members**, click the **ADD** button and enter the IP address of the encoder to be added to the group.
6. Click the **Interface** drop-down list to select the desired interface.
7. Click the **SUBMIT** button to commit changes to the encoder group.
8. Repeat steps 5 through 8 for each encoder to be added to the encoder group.

 **IMPORTANT:** The IP address for each encoder must be added to the group. This includes the IP address of the encoder that is being used to create the group.

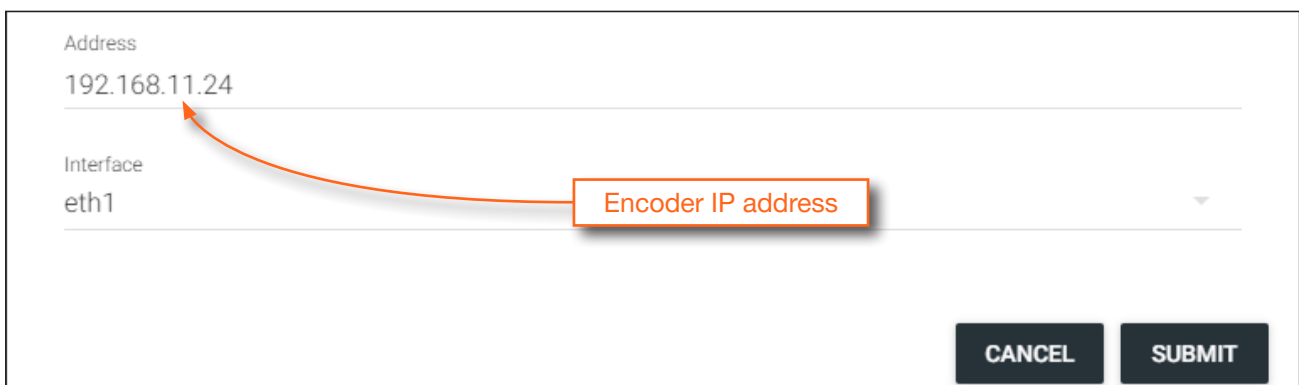

- Click the **Enable Encoder Group** toggle switch to enable encoder grouping. When enabled, this toggle switch will be green.
- Click the **Trigger** drop-down list and select the desired trigger mode.

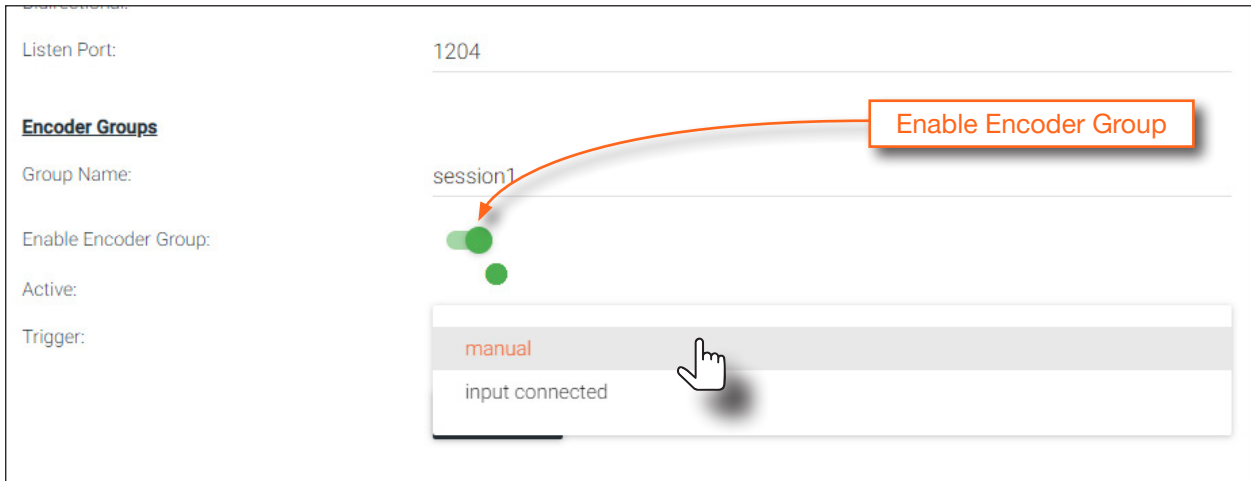

Mode	Description
manual	Use this setting to manually enable the input. When set to manual, click the <b>Activate</b> button to perform the input switching.
input connected	Use this setting to allow the encoder group to use automatic input detection. Once a new source is connected, that source becomes the active source.



**NOTE:** Setting **Trigger** to **input connected** should not be used when **Slate Mode** is set to **Auto**. Doing so will cause the slate to be displayed when switching inputs. If encoder auto-switching is being used, set the **Slate Mode** to **Auto**, on the decoder. Refer to [Slate / Logo Insertion \(page 70\)](#) for more information.

- Click the **SAVE** button, at the bottom of the **Stream** window group to commit all changes.



### Daisy-Chaining Encoders

Encoders can be daisy-chained to one another. This is particularly useful when only a single distribution point and one display exists in a room. Daisy-chaining transforms multiple encoders into a single multiple-input encoder with a single multicast IP address.

In the diagram below, three dual-channel OmniStream encoders are connected to a switch. In order to daisy-chain them, they must be reconnected in a different configuration. Each encoder has been labeled with an arbitrary IP address, for identification purposes.



**NOTE:** Single-channel encoders do not support daisy-chaining. In addition, the OmniStream R-Type Encoder (AT-OMNI-512) does not support daisy-chaining and *cannot* be combined with OmniStream Pro daisy-chain configurations.

1. Reconnect the encoders to one another, and to the switch, as shown in the illustration below.
2. Connect the optional OmniStream power supply (AT-PS-48083-C) to each encoder in the chain.



**IMPORTANT:** The optional OmniStream power supply (AT-PS-48083-C) must be connected to each encoder that is daisy-chained, in order to supply the required power. Note that since each encoder must use an external power supply, connection to a PoE switch is not required.

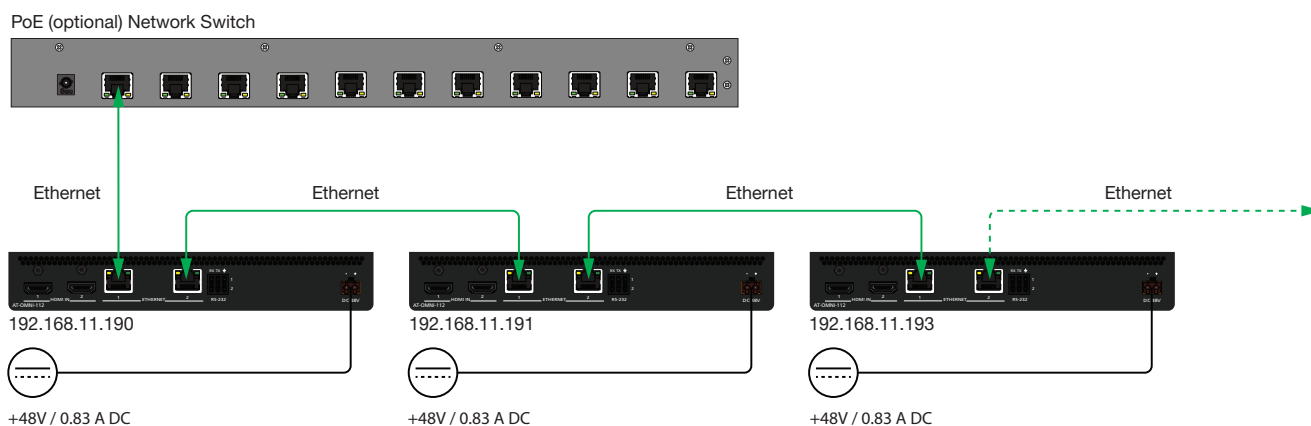

3. Login to AMS. Refer to [Accessing Encoders in AMS \(page 16\)](#), if necessary.
4. Click **SESSION** in the menu bar.
5. Create an encoder group for using each encoder in the chain. Refer to [Encoder Grouping \(page 63\)](#) for more information. Since there are three encoders in this example, each encoder will be listed under the **Session** page, as shown. Encoders can be added to an encoder group in any order.

Figure 1. Daisy-chained encoders with single decoder and display (sink).

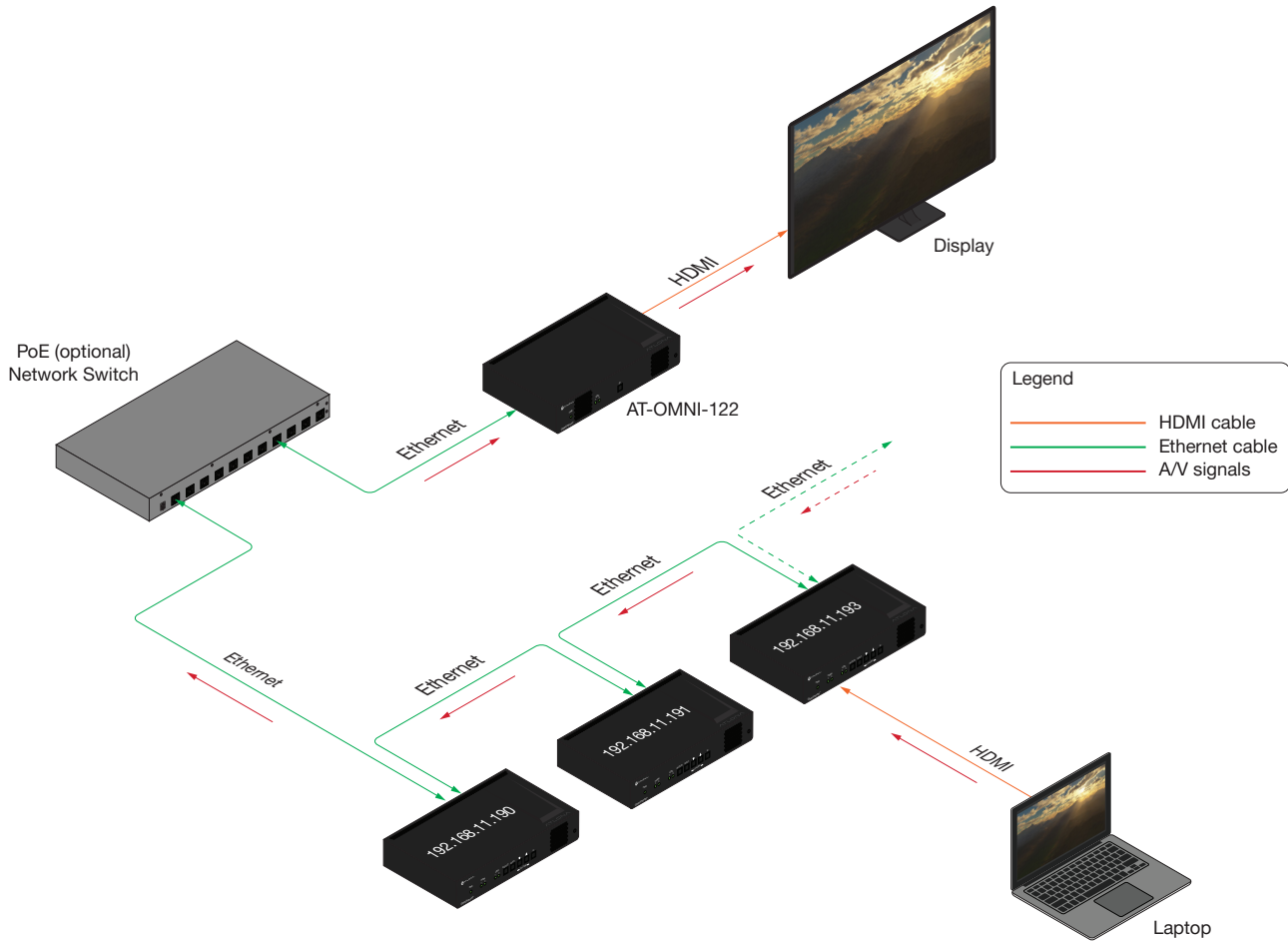

To delete an encoder from the **Members** list, click the  icon to the right of its IP address.

- Click the **Trigger** drop-down list to select the trigger mode. Selecting the trigger mode will set how the OmniStream encoder will respond when a source is disconnected/connected.

The diagram above shows a basic daisy-chain setup. The path of the A/V signal is identified with red arrows. When encoders are daisy-chained, they function as one single encoder. In this example, daisy-chaining three dual-channel encoders, creates a single “logical” encoder with six HDMI inputs.

When daisy-chaining encoders, the following rules apply:

- All encoders will stream content using the same multicast IP address. Therefore, the decoder must be subscribed to this multicast IP address in order to display the content.
- Daisy-chained encoders can only display one source at a time. Click the **Trigger** drop-down list to determine how the encoder will handle switching between sources.
- The last source that is connected will be the one that is displayed. However, this is only occurs if the **Trigger** mode is set to **input connected**.
- Pressing the **INPUT** button, on the front panel of an encoder, will toggle between HDMI inputs.

## Scrambling

OmniStream supports 128-bit Advanced Encryption Standard (AES) scrambling and is required for HDCP-encrypted streams. Scrambling can be enabled or disabled through AMS, and can be applied to individual sessions. In order for scrambling to function properly, it must be enabled on both the encoder session and all decoders subscribed to a stream that is a part of a scrambled session. The scrambling key on both encoder and subscribed decoder(s) must be identical. When enabled, the default scrambling key is “scrambling”.

### Standard Method

1. Login to AMS. Refer to [Accessing Encoders in AMS \(page 16\)](#), if necessary.
2. Click **SESSION** in the menu bar.
3. Under the desired **Stream**, click the **Scrambling** toggle switch to enable it. Once enabled, the toggle switch will be green and the **Key** field will be displayed.

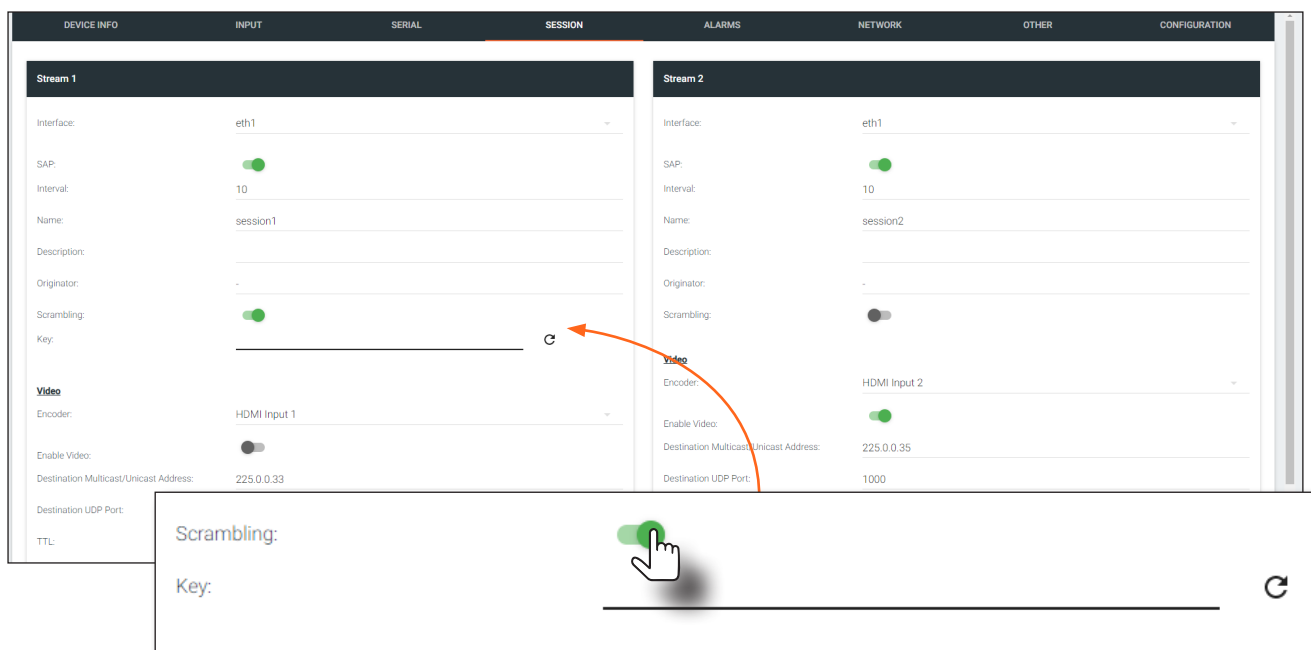

4. Enter the desired scrambling key in the **Key** field. If a random key is desired, click the  icon to generate a key. Each time this icon is clicked, a new scrambling key will be generated.









**IMPORTANT:** If a user-defined key is specified, then it must be a minimum of eight alphanumeric characters. Special characters and spaces are not permitted. Also note that if a key is generated, the same generated key (on the encoder) must also be used on the decoder, in order to de-scramble the signal.

5. Click the **Save** button at the bottom of the page to commit the changes.

### Using the Virtual Matrix

1. Access the Virtual Matrix. Refer to [The Virtual Matrix \(page 93\)](#) for more information.
2. Locate the desired encoder or decoder. Scrambling is managed on the encoder; descrambling is managed on the decoder.
3. Click the key icon. The Scrambling dialog box will be displayed. If the key icon for a decoder is clicked, then the Descrambling dialog box will be displayed.

<b>AT-OMNI-112</b> 10.20.40.26 10.20.40.26 at-omni-112-0041 <b>Connected</b> 	HDMI 1 In		
	HDMI 2 In		
<b>AT-OMNI-512</b> 10.20.40.17	HDMI 1 In		

4. Click the **Enable** toggle switch to enable scrambling for the desired session.

### Scrambling - AT-OMNI-112 : 10.20.40.26

**Session: session1**

Enable

Key



**Session: session2**

Enable

Key



CLOSE
SAVE

5. Enter the desired scrambling key using one of the following methods:
  - Manual enter a user-defined key in the **Key** field.
  - Click the  icon to generate a random key using AMS. Each time this icon is clicked, a new scrambling key will be generated.
6. Repeat the above process for each session.
7. Click the **Save** button to commit the changes.

## Setting the Video Mode

OmniStream offers two video modes: Video and PC application. These two modes will optimize the video, based on the type of information that is being displayed. Use the **Video** mode when display motion graphics/video. Set this mode to **PC application** when viewing static images, such as spreadsheets or similar content.

1. Login to AMS. Refer to [Accessing Encoders in AMS \(page 16\)](#), if necessary.
2. Click **INPUT** in the menu bar.
3. Click the **SHOW ADVANCED** button, under the **HDMI Input 1** window group.
4. Click the **Video Optimization** drop-down list to select the desired mode.

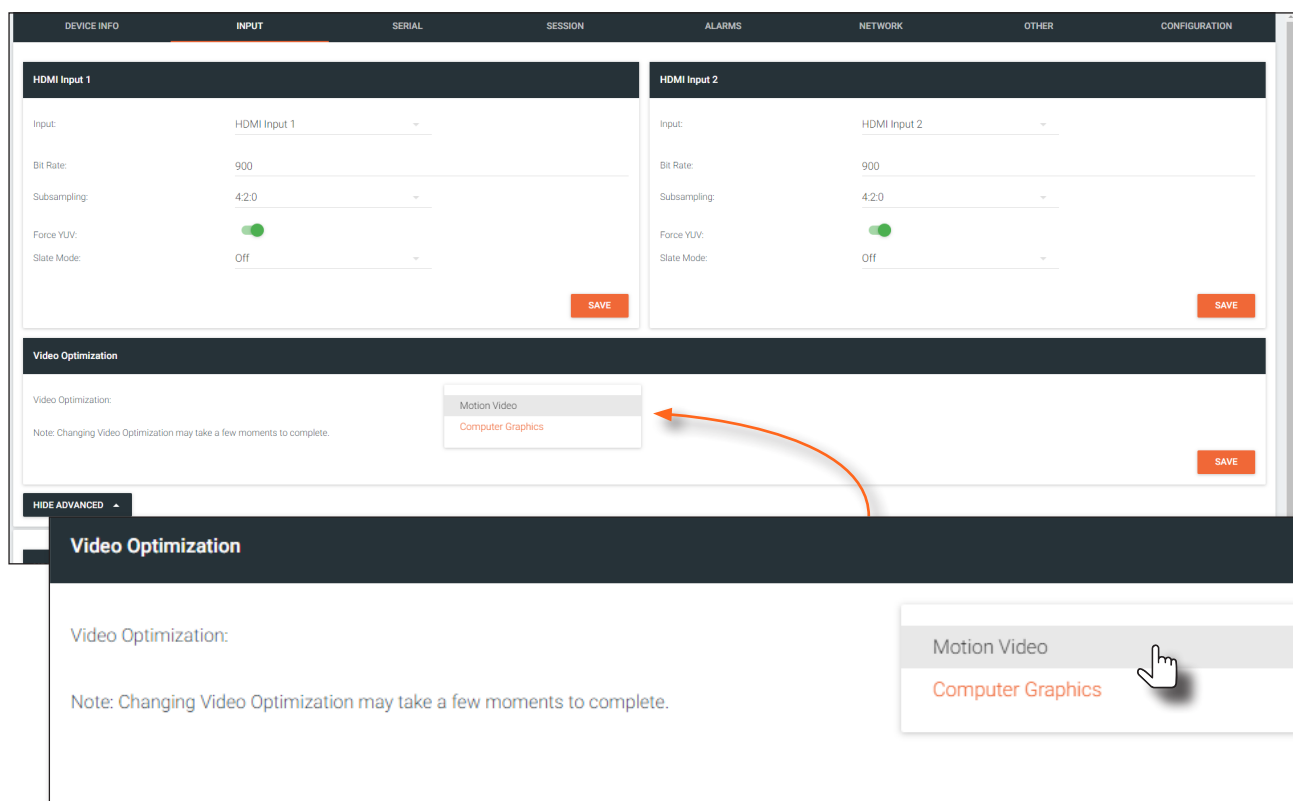

Mode	Description
Computer Graphics	Optimizes the image when viewing static images, such as spreadsheets or similar content.
Motion Video	Provides the best viewing experience when streaming motion graphics and/or video.

4. Click the **SAVE** button, within the **Video Optimization** window group to commit changes. Note that switching between video modes may take a few moments to complete.
5. Go to the decoder interface and repeat the process. Refer to the *OmniStream Single-Channel / Dual Channel A/V Decoder User Manual*, if necessary.



**IMPORTANT:** In order to use 3840x2160p60 signals, **Video Optimization** must be set to **Motion Video**.

## Slate / Logo Insertion

Slate / logo insertion is managed from within AMS. The difference between a “slate” and “logo” is in the size of the image and how it is used: Logos are classified as smaller, low-resolution images that can be positioned at specified locations on the screen. Slates occupy the entire screen. Note that while logos may be used as slates, the image quality will be degraded, as the image will be scaled to fill the screen.

Slate / logo insertion can be performed on both the encoder and decoder. When configured on the encoder, the image that is displayed on the output (decoder) will be from the encoder IP address(es) to which each decoder is subscribed. When configured on the decoder, the image is unique to the specified HDMI output. Refer to the *OmniStream Single-Channel / Dual Channel A/V Decoder User Manual*, for information on managing slate / logo insertion on decoder units.

### Adding Slates / Logos

1. Login to AMS. Refer to [Accessing Encoders in AMS \(page 16\)](#), if necessary.
2. Click **OTHER** in the menu bar.
3. Verify that **Logo** is selected, near the upper-left corner of the screen. **Logo** is the default selection and applies to both logo and slate images.
4. Enter the name of the image in the **Name** field. If a name is not specified, then the **UPLOAD** button will be disabled.
5. Under the **New logo** window group, click the **Choose File** button and select the image to be used. Only .png files are valid selections.
6. Click the **UPLOAD** button to upload the file.

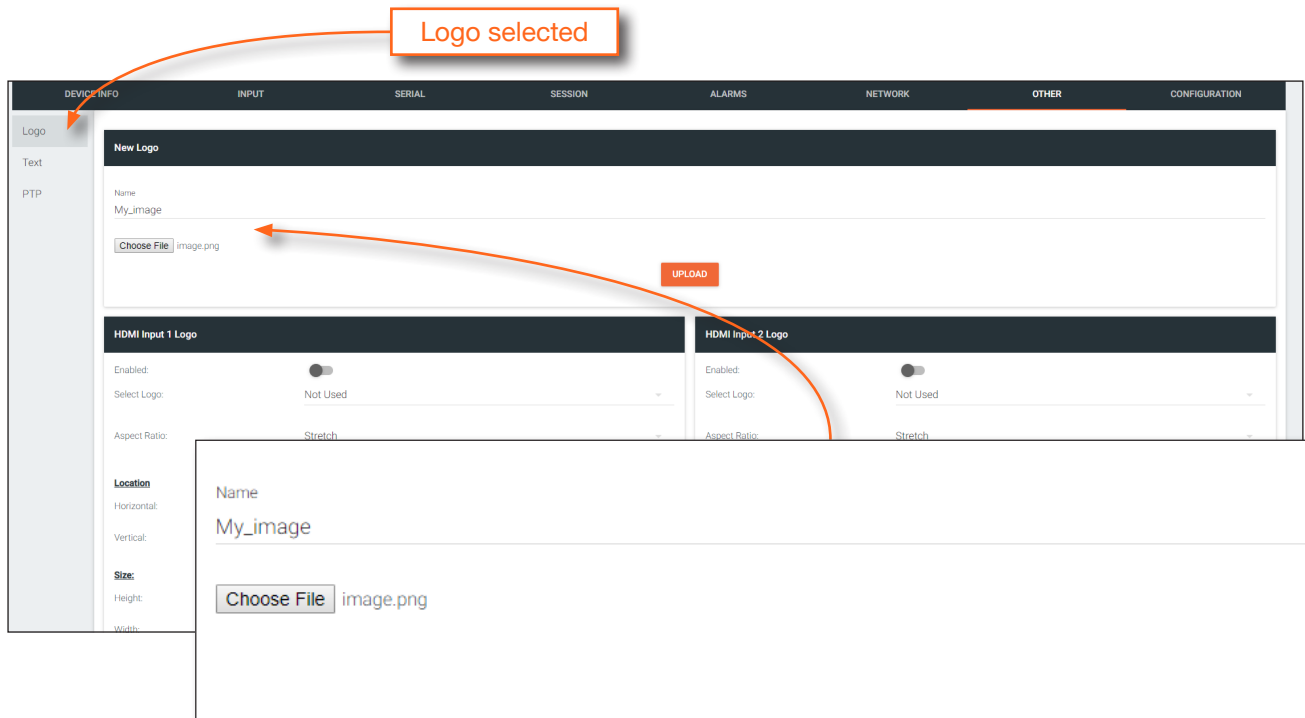

7. A new window group will be created with the name of the logo that was provided in Step 4.

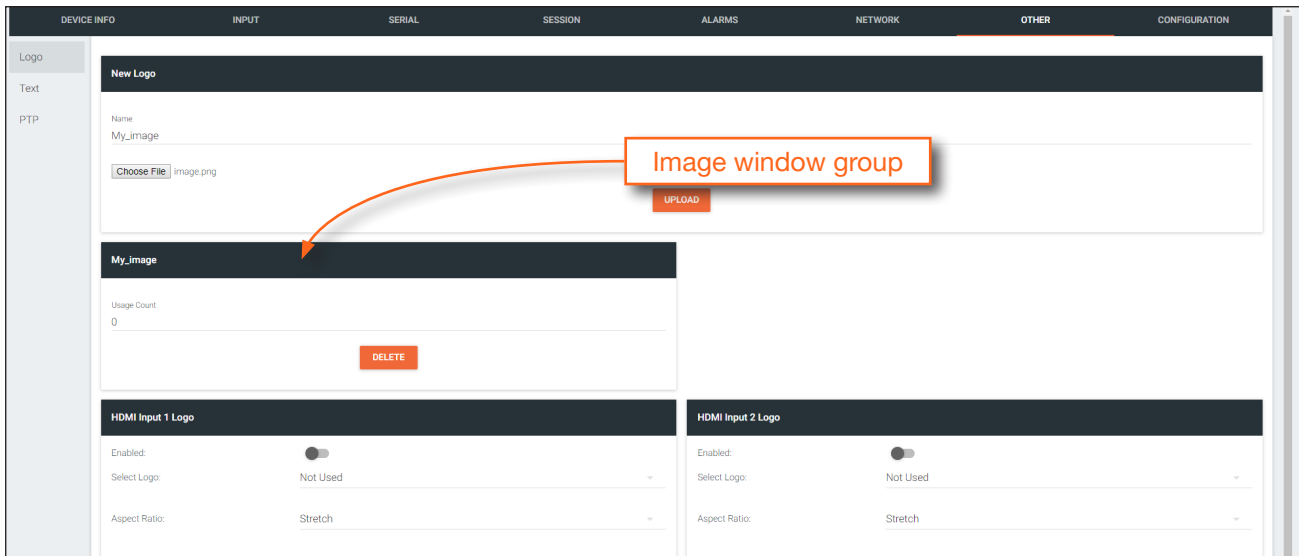

8. Perform one of the following:

- If the selected image will be used as a *logo*, then proceed with Steps 9 through 13.
- If the image will be used as a *slate*, skip to Step 14.

9. Under the **HDMI Input Logo** window group, click the **Select Logo** drop-down list and select the desired logo. To prevent the image from being displayed, select the **Not used** option.

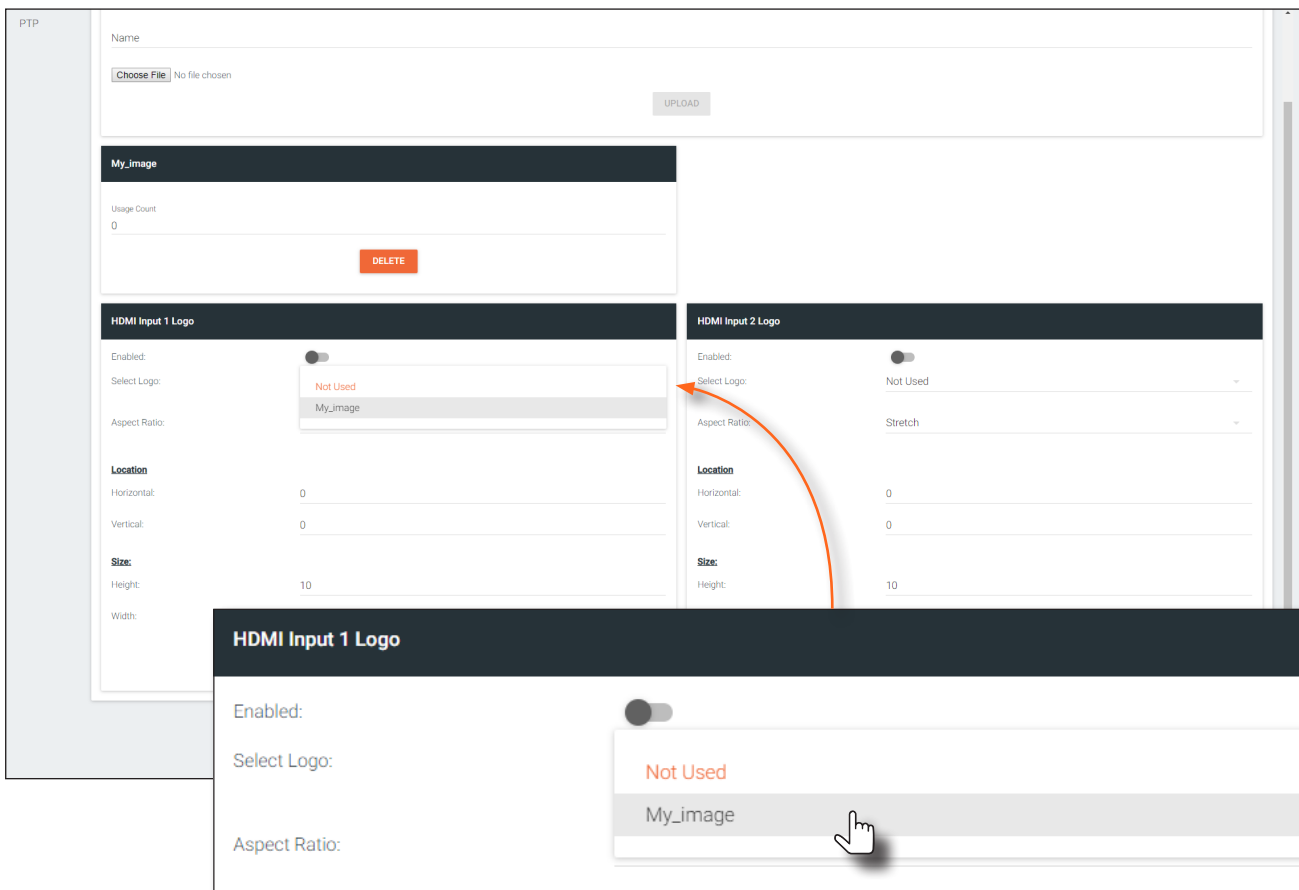

- Click the **Aspect Ratio** drop-down list to set the aspect ratio of the image. Selecting **Keep** will maintain the aspect ratio. Select **Stretch** to scale the image to fill the screen.
- Enter the location of the on-screen image, in pixel values, by entering the desired values in the **Horizontal** and **Vertical** fields.
- Click the **Enabled** toggle switch to activate the logo/slate feature. When enabled, this toggle switch will be green.
- Click the **SAVE** button to commit changes.
- Click **INPUT** in the menu bar, then click the **SHOW ADVANCED** button.
- Click the **Slate mode** drop-down list, and select **Off**, **Manual**, or **Auto**.

Mode	Description
Off	Disables the image from being displayed.
Manual	The image will always be displayed, superimposed on the source signal, and will remain even if the source signal is lost.
Auto	The image will only be displayed when the source signal is lost. For example, this mode is useful in conference room applications for displaying system instructions when no sources are connected.

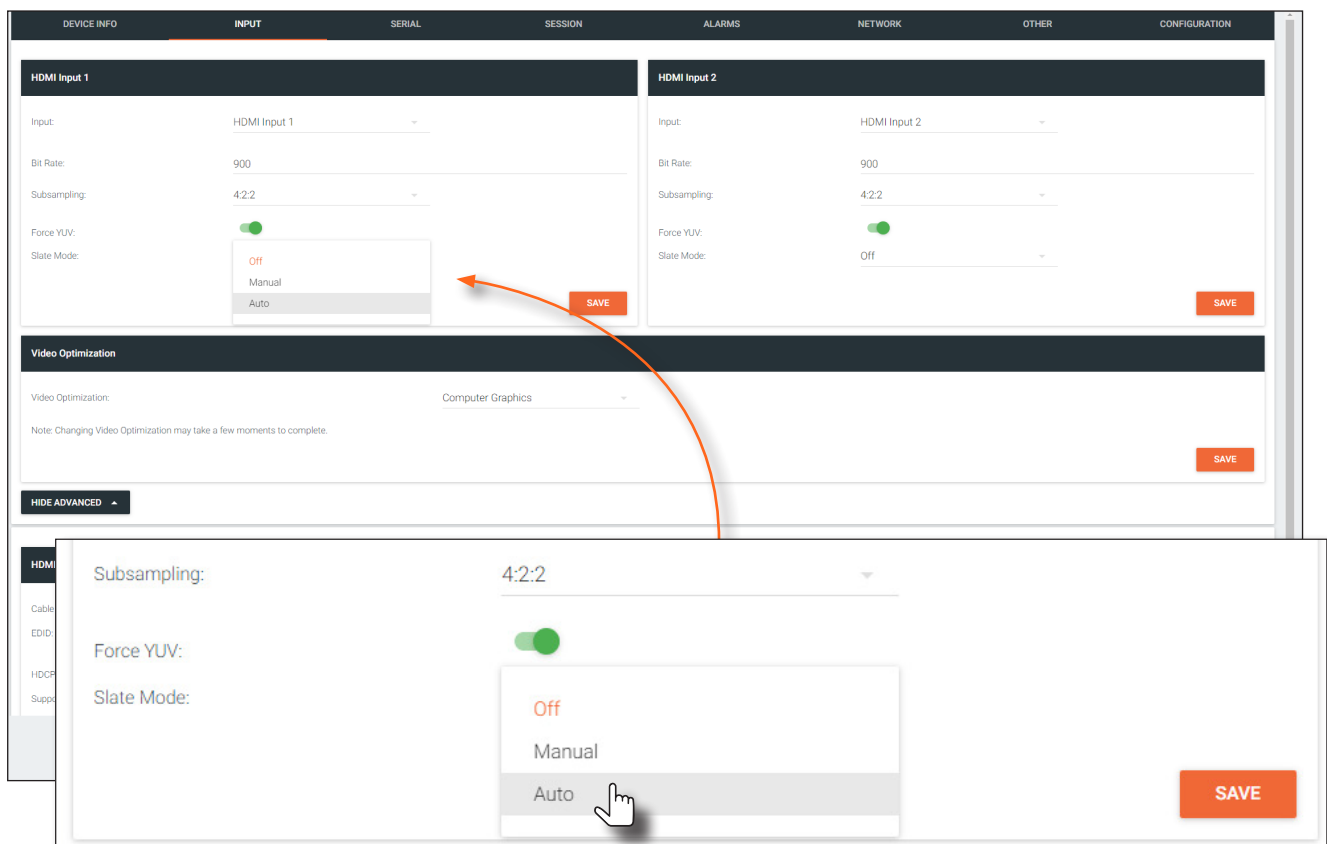

The screenshot displays the configuration interface for the AT-OMNI-111 / AT-OMNI-112 device. The top navigation bar includes tabs for DEVICE INFO, INPUT, SERIAL, SESSION, ALARMS, NETWORK, OTHER, and CONFIGURATION. The main content area is divided into sections for HDMI Input 1 and HDMI Input 2, and a Video Optimization section. The Slate Mode dropdown menu is highlighted, showing the options Off, Manual, and Auto. A red arrow points from the Save button to the Slate Mode dropdown. A zoomed-in view of the Slate Mode dropdown is shown below, with a hand cursor pointing to the Auto option.

- Click the **Slate Logo** drop-down list and select the desired image. Note that if **Slate Mode** is set to **Off**, then this field will not be visible.
- Click the **SAVE** button to apply all changes.



### Deleting Slates / Logos

Follow the instructions below to remove a logo/slate image.

1. Click **OTHER** in the menu bar.
2. Click the **DELETE** button in the desired image window group. When the **DELETE** button is clicked, the window group and the associated image will be deleted from the encoder. If the **DELETE** button is disabled, do the following:
  - a. Locate the **HDMI Input Logo** window groups.
  - b. Click the **Select Logo** drop-down list and select **Not Used**.
  - c. Click the **SAVE** button.
  - d. Refresh the page.
  - e. Click the **DELETE** button to remove the logo.

## Text Insertion

1. Login to AMS. Refer to [Accessing Encoders in AMS \(page 16\)](#), if necessary.
2. Click **OTHER** in the menu bar.
3. Click **Text** in the side menu bar, in the upper-left corner of the AMS screen.
4. Click the **Enabled** toggle switch, to allow the text to be displayed. When enabled, this toggle switch will be green.

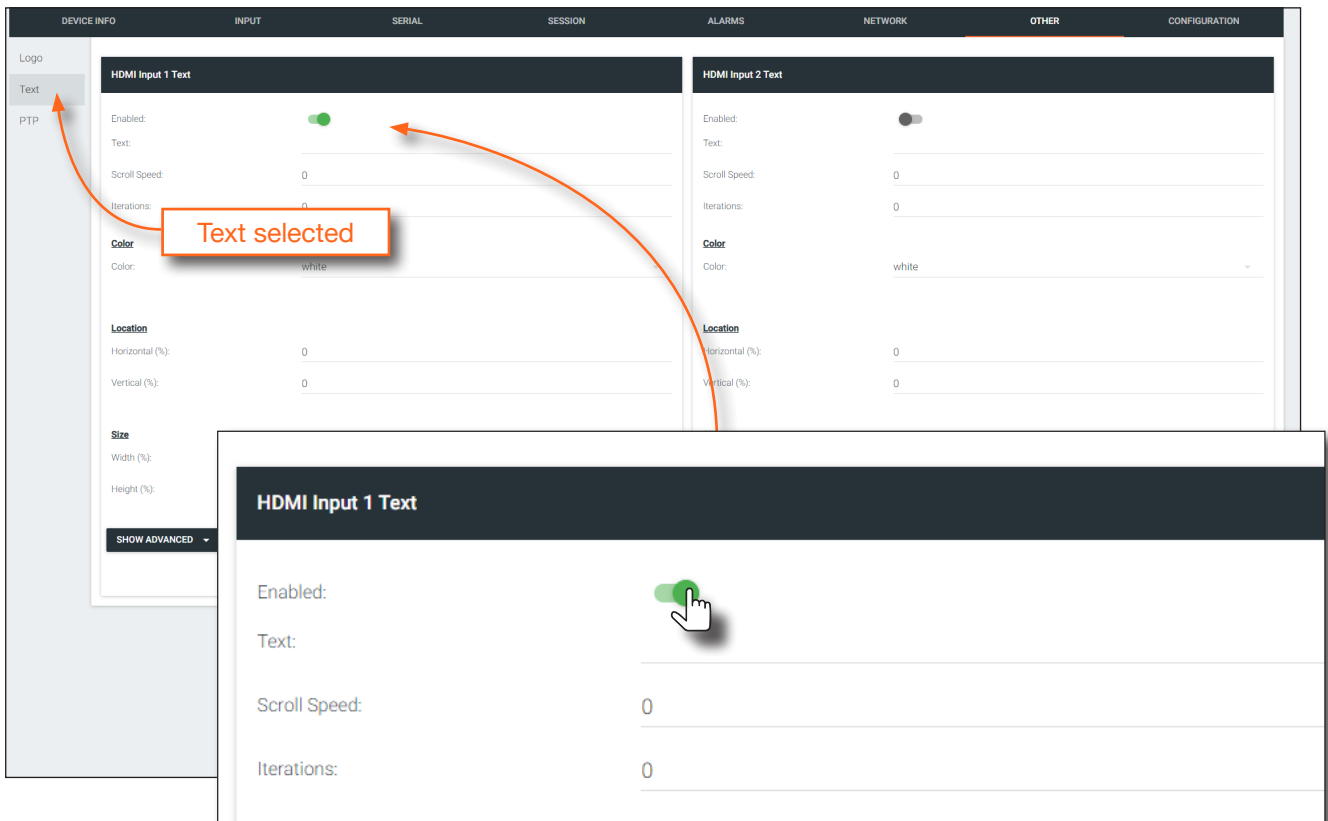

4. In the **Text** field, enter the desired text.
5. Specify the speed of the scrolling text in the **Scroll Speed** field. Values from -255 to 255 are valid. Negative numbers will scroll the text from left to right. Positive numbers will scroll text from right to left.
6. Enter the number of iterations in the **Iteration** field. Set this field to 0 (zero) to set the number of iterations to infinity.
7. Click the **Color** drop-down list to select the color of the text. The **Red**, **Green**, and **Blue** fields can be changed to further modify the color of the text. Adjust the **Alpha** field to control the transparency of the text. A value of 255 is opaque and a value of 0 is transparent. Numbers from 0 to 255 are valid for each of these fields.
8. Specify the location of the text in the **Horizontal (%)** and **Vertical (%)** fields. Each of these values is based on the horizontal and vertical resolution of the screen.
9. Specify the size of the text in the **Width (%)** and **Height (%)** fields. Each of these values is based on the horizontal and vertical resolution of the screen.
10. Click the **SAVE** button to commit all changes.

# The AMS Interface

## Device Info page

The **Device Info** page provides general information about the encoder.

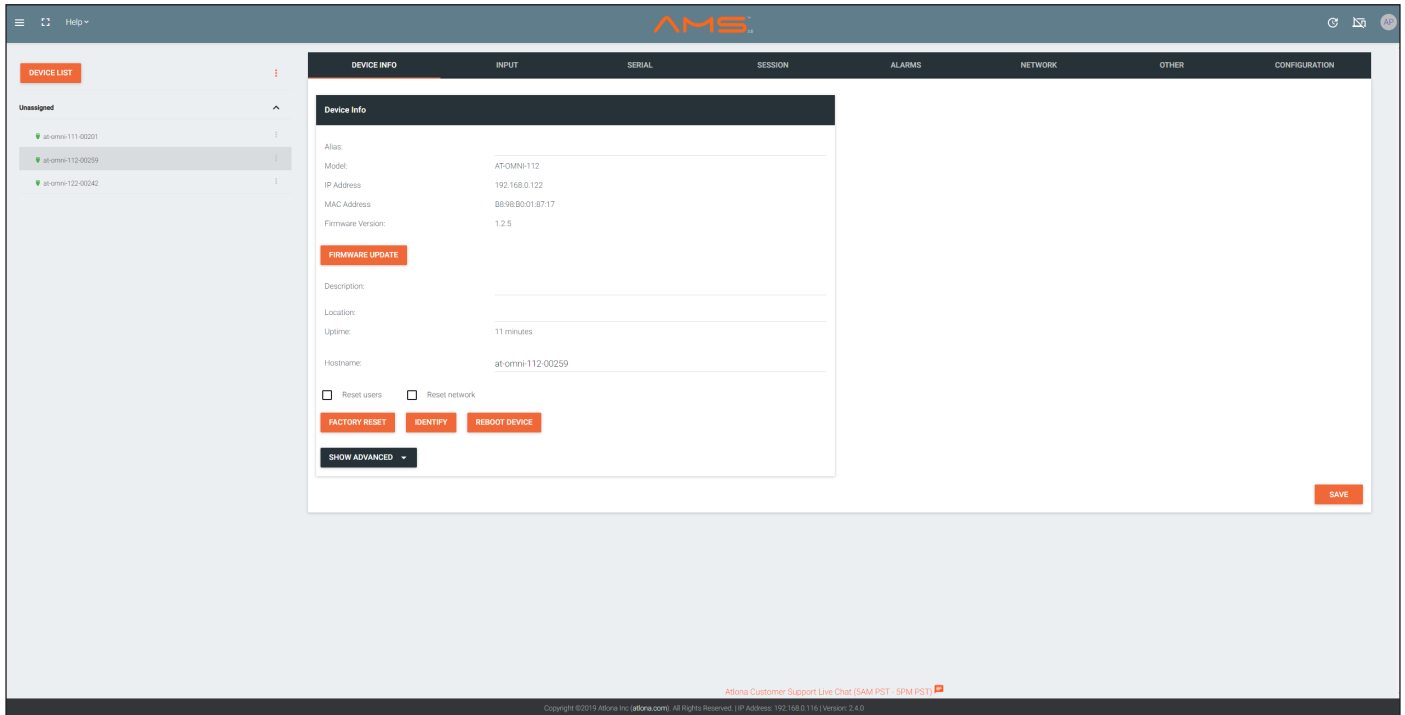

### Alias

Enter a name for the unit in this field. This is optional.

### Model

The model number of the unit.

Model	Description
AT-OMNI-111	Single-channel encoder
AT-OMNI-112	Dual-channel encoder

### IP Address

Displays the IP address of the encoder.

### MAC Address

Displays the MAC address of the encoder.

### Firmware version

The version of firmware that the encoder is running. Always make sure the latest version of firmware is installed.

### FIRMWARE UPDATE

Click this button to update the firmware.

### Description

Provides the option of assigning descriptive name to the unit.

### Location

Provides the option of assigning descriptor for the location of the unit.

### Uptime

Time elapsed since the last reboot operation.

### Hostname

The hostname of this unit. This can be changed if desired. By default, the host name is automatically created using the model of the unit and adding the last five digits of the unit serial number.

### FACTORY RESET

Click this button to reset the encoder to factory-default settings. When performing a factory reset, the following options can be selected, by clicking the check box. If no options are selected, then the encoder is reset with no factory-default settings.

Option	Description
None Checked	Resets the encoder with no factory-default settings.
Reset User	Resets the encoder to factory-default settings and resets custom user information.
Reset Network	Resets the encoder to factory-default settings and resets network information.
Reset Defaults	Resets the encoder to factory-default settings. In addition, static multicast addresses are configured. This option can be used to configure a single encoder to transmit to any number of decoders without using the Virtual Matrix within AMS.   <b>IMPORTANT:</b> This option will not work for multiple encoders on the same network.

### IDENTIFY

Click this button to physically identify a unit on the network. Clicking this button will cause all front-panel LED indicators to flash for 10 seconds.

### REBOOT DEVICE

Click this button to perform a soft reboot of the encoder.

### Advanced Settings

Click the **SHOW ADVANCED** button to view the following options.

#### Timezone

Click this drop-down list to select the time zone, expressed in Universal Coordinated Time (UTC).

#### System Temperature

The current internal temperature of the unit listed in both degrees Fahrenheit and Celsius.

#### Die Temperature

The component chip temperature listed in both degrees Fahrenheit and Celsius.

#### Power Consumption

The current power consumption value.

**NTP Server**

Specify the desired NTP server in this field. This provides timestamps for any logs and alarms.

**Buttons**

Disabling this feature will lock the ID button on the front panel. This feature is enabled by default.

**LEDs**

Disabling this feature will turn off all LED indicators on the front panel. This is enabled by default.

## Input page

The **Input** page provides signal information for each channel (input). If using the single-channel encoder, only a single (input) channel will be displayed.

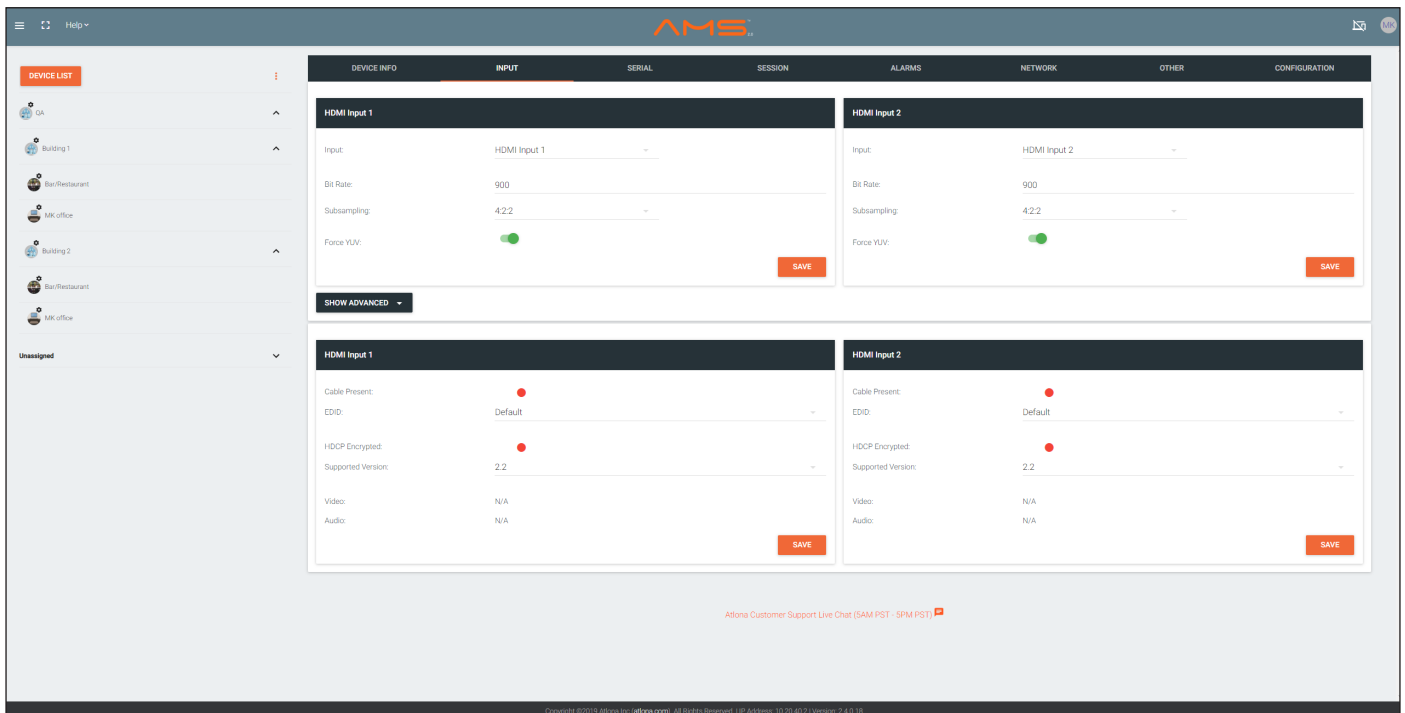

### Input

The selected input. This value can be **HDMI Input 1**, **Video Generator 1**, or **None**.

### Bit Rate

The current video bit rate. Specifying lower bit rates will reduce video quality. This value is in megabits-per-second (Mbps). 4K/UHD streams should be set to 900 Mbps. The recommended bandwidth for 1080p60 video is also 450 Mbps. Setting this field below these recommended values will result in lower-quality video.

### Subsampling

Click this drop-down list to select the desired maximum chroma subsampling value. Any input with a higher chroma subsampling will have their chroma scaled to the configured value using a very high quality chroma scaler to preserve quality.

### Force YUV

When this toggle switch is enabled (green), the encoder will stream YUV content over the network, regardless of which color space is used by the HDMI source. When the decoder receives the YUV stream, it will output YUV on the HDMI output. However, if the decoder is connected to a display that requires RGB, as determined by the EDID of the display, then the decoder will convert the video signal to RGB on the HDMI output. In order for the chroma scaling to work on RGB inputs, this option must be enabled.

### Cable Present

Indicates whether or not a connection is detected. The indicator, to the left, indicates the current state. If the indicator is green, then a source signal is detected. If the indicator is red, then check the cable connection and make sure that the source is powered. Damaged cables may also display a red indicator.

### EDID

Click the drop-down list to select the desired EDID. Refer to the table below for a list of available EDID selections.

EDID	Description
Default	Default OmniStream EDID
ATL 1080P 2CH	1920x1080p60 with two-channel PCM audio
ATL 1080P DD	1920x1080p60 with Dolby Digital audio
ATL 1080P DVI	1920x1080p60 with video formatted as DVI
ATL 1080P MCH	1920x1080p60 with multichannel PCM audio
ATL 1280x800 RGB DVI PCWXGADVI	1280x800p60 with video formatted as DVI
ATL 1280x800 RGB PCWXGA2CH	1280x800p60 PC format with two-channel PCM audio
ATL 1280x800 RGB TVWXGA2CH	1280x800p60 TV format with two-channel PCM audio
ATL 2160P 2CH	3840x2160p30 with two-channel PCM audio
ATL 2160P MCH	3840x2160p30 with multichannel PCM audio
ATL 2560x1600 2CH	2560x1600p60 with two-channel PCM audio
ATL 2560x1600 MCH	2560x1600p60 with multichannel PCM audio
ATL 4K60 MCH	3840x2160p60 with multichannel PCM audio
ATL 4K60 PCM_MCH	3840x2160p60 with two-channel / multichannel PCM audio
ATL 720P DD	1280x720p60 with Dolby Digital audio
ATL 720P 2CH	1280x720p60 with Dolby Digital two-channel audio

### HDCP Encrypted

Indicates if the content being transmitted from the source is HDCP-encrypted. If using HDCP-encrypted content is being used, then this indicator will be green.



**NOTE:** Disabling **HDCP compliance** *does not* decrypt HDCP content.

### Supported Version

Click this drop-down list to select the version of HDCP to be supported: **2.2**, **1.4**, or **None**. If **None** is selected, then HDCP-encrypted content cannot be passed-through.

### Video

The current sampling rate for the input video signal.

### Audio

The sampling frequency for the input audio signal.

### Advanced Settings

Click the **SHOW ADVANCED** button to view the following options.

#### Slate Mode

Click this drop-down list to enable slate mode or select the desired slate to be used. Refer to [Slate / Logo Insertion \(page 70\)](#) for more information.

#### Video Optimization

Sets the output video mode. Refer to [Setting the Video Mode \(page 69\)](#) for more information.



## Serial page

The **Serial** page provides serial port configuration when using control signals.

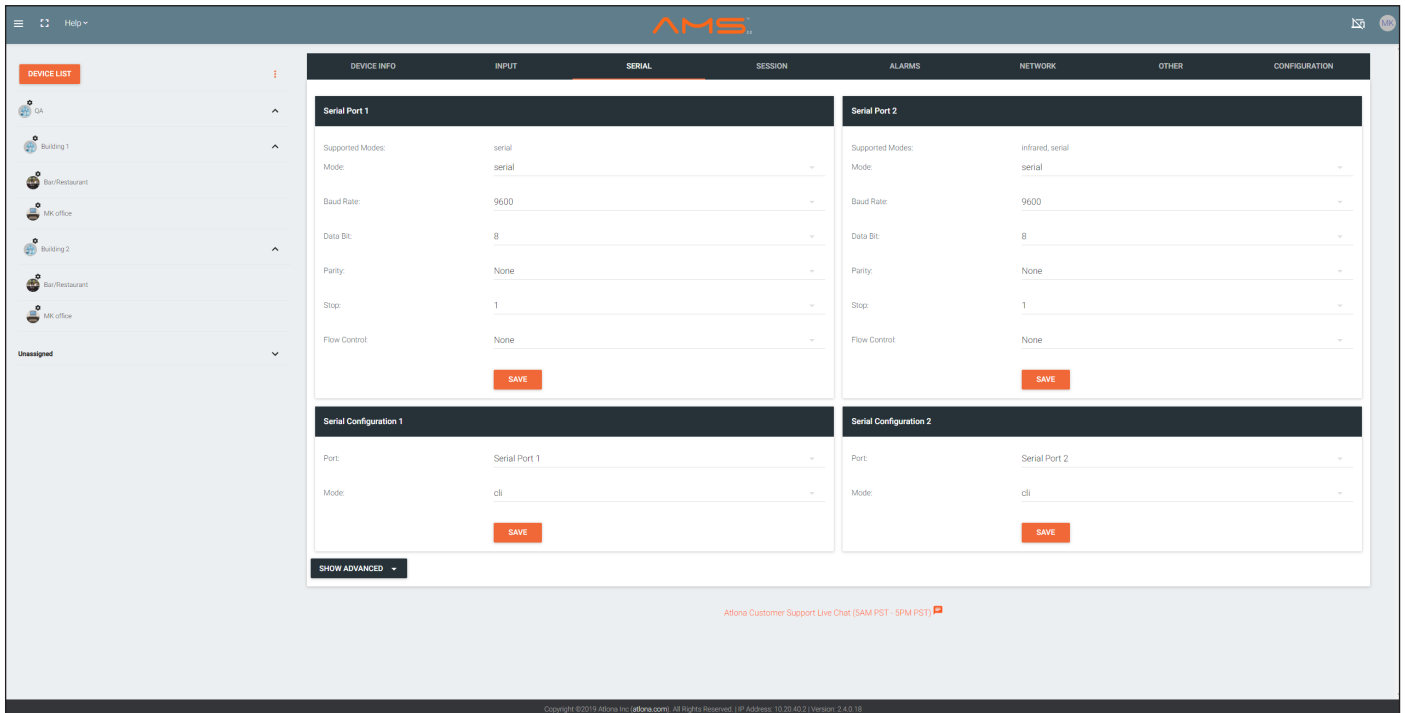

### Supported Modes

Lists the supported protocols for the serial port.

### Mode

Click this drop-down list to select the desired serial mode.

### Baud Rate

Click this drop-down list to select the desired baud rate: **9600, 19200, 38400, 57600, or 115200.**

### Data Bit

Click this drop-down list to select the number of data bits: **6, 7, or 8.**

### Parity

Click this drop-down list to select the parity bit: **None, Odd, Even, Mark, or Space.**

### Stop

Click this drop-down list to select the stop bit: **1, 1.5, or 2.**

### Flow Control

Click this drop-down list to select the type of flow control: **None, xonxoff, or hw.**

### Port

Click this drop-down list to select the desired serial port: **Serial Port 1 or Serial Port 2.**

### Mode

Click this drop-down list to select the desired control mode: **cli or tcpproxy.**

### Advanced Settings

Click the **SHOW ADVANCED** button to view the following options.

#### Command

Each of these **Command** window groups are used to enter the command string for the desired operation: **Display Off**, **Display On**, **Volume Down**, and **Volume Up**.

#### Interpret on

Click this drop-down list to select where the command will be interpreted.

Interpret on	Description
decoder	Commands are interpreted at the decoder.
encoder	Commands are interpreted at the encoder.

#### ASCII

Enter the ASCII representation of the command string in this field.

#### HEX

Enter the hexadecimal representation of the command in this field.



**NOTE:** When entering the command string, it is not required to enter the string under both the ASCII and HEX fields. The encoder requires that one field be completed.

## Session page

The **Session** page provides the ability to configure all session parameters. Up to four sessions are supported on dual-channel encoders. Single-channel encoders are limited to a maximum of two sessions.

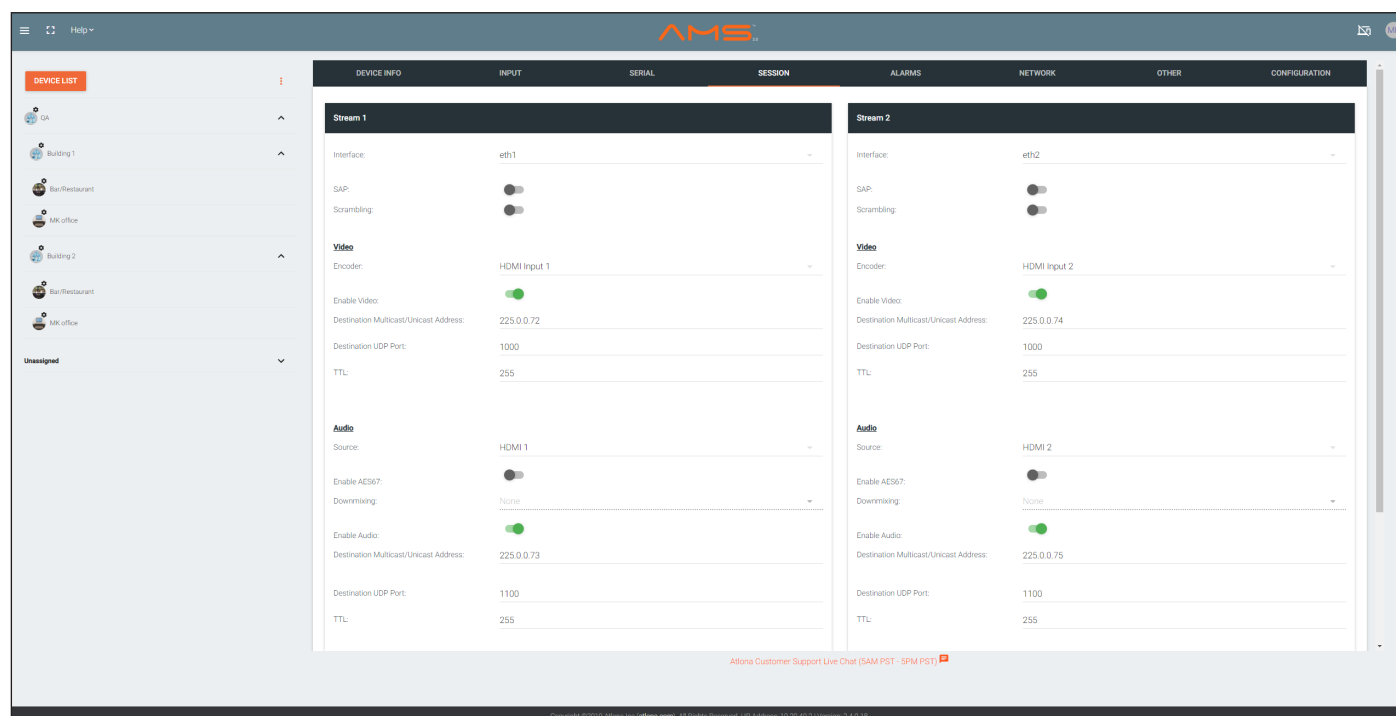

### Interface

Click this drop-down list to select the desired interface.

Interface	Description
eth1	ETHERNET 1 port
eth2	ETHERNET 2 port

### SAP

Click this switch to enable to disable the Session Announcement Protocol. When enabled, the toggle switch will be green.

### Scrambling

Click this toggle switch to enable (green) or disable scrambling.

### Key

This field is only displayed if the **Scrambling** toggle switch is enabled (green). Enter the scrambling key in this field. The scrambling key must be ASCII and must contain a minimum of eight characters. Special characters and spaces are not permitted.

### Encoder

Click this drop-down list to select the desired HDMI input.

### Enable Video

Click the toggle switch to enable or disable the video stream. When enabled, the toggle switch will be green. By default, video streaming is *enabled*. Disabling the video stream can be used to “mask” the video on the decoder endpoints.

### Destination Multicast/Unicast Address

Enter the IP address of the decoder that will be receiving the video stream. By default, AMS will automatically populate multicast IP addresses for the encoder.

### Destination UDP Port

Enter the destination UDP port in this field.

### TTL

Set the TTL (Time-To-Live) duration, from 1 to 255 seconds, in this field. The default value is 255 seconds.

### Source

### Input

Select the desired HDMI input from the **Source** drop-down list.

### Enable AES67

Click this toggle switch to enable AES67. When this feature is enabled, the toggle switch will be green.

### Downmixing

This field will only be available when AES67 is enabled.

### Enable Audio

Click the toggle switch to enable the audio stream. By default, audio streaming is *disabled*.

### Destination Multicast/Unicast Address

Enter the IP address of the decoder that will be receiving the audio stream.

### Destination UDP Port

Enter the destination UDP port in this field.

### TTL

Set the TTL (Time-To-Live) duration, from 1 to 255 seconds, in this field. The default value is 255 seconds.

### Source

Click this drop-down list to select the method of how commands are transmitted.

Source	Description
Not Used	Serial control is disabled
Commands	Commands are sent using CEC (over HDMI)
Serial Port 1	Commands are transmitted using Serial Port 1
Serial Port 2	Commands are transmitted using Serial Port 2

### Advanced Settings

Click the **SHOW ADVANCED** button to view the following options. **DSCP**, **FEC Enable**, **FEC Rows**, and **FEC Columns** apply to both **Video** and **Audio** sections.

#### DSCP

*Differentiated Services Code Point* (DSCP) is a method of managing network traffic, in addition to providing *Quality of Service* (QoS) within the Layer-3 (Network Layer) of the OSI network model. DSCP uses the 6-bit Differentiated Services (DS) field in the IP header in order to determine packet classification/priority. Normally, all routers and switches will forward network traffic to the proper destination with the same priority, no matter what type of data it is. This methodology is what is known as *Best Effort*.

The **Best Effort** setting will provide normal priority for data packets, while other settings will raise the priority on data packets. However, it should be noted that a higher priority setting on one type of data type may also result in data packet loss for other data types, depending upon network traffic.

When QoS or differentiated services policy is used, all network devices such as routers, networks switches, and end-devices must be configured properly in accordance with QoS policies on the network. There are two main methodologies for tagging traffic: Assured Forwarding and Class Selectors.

The following tables provide a list of the available selections and their description.



**IMPORTANT:** Consult the IT administrator as to what methods to use and the required settings for each encoder on the network.

Table 1.1 - Assured Forwarding

Selection	Queue Classification	Drop Probability
AF11	Class 1	Low
AF21	Class 2	Low
AF31	Class 3	Low
AF41	Class 4	Low

Table 1.2 - Class Selectors

Selection	Class Selector Name
CS0 / Best Effort	Routine
CS1	Priority
CS2	Immediate
CS3	Flash
CS4	Flash Override
CS5	Critical
CS6	Interwork Control
CS7	Network Control
EF	Expedited Forwarding

**FEC Enable**

Click this toggle switch to enable (green) or disable Forward Error Correction (FEC). This feature can be used when transporting streams over a network that is suspected to be unreliable, due to noise or other factors. By default, this feature is enabled. Refer to [FEC Details \(page 134\)](#) for more information.

**FEC rows**

Specify the number of FEC rows in this field. Refer to [FEC Details \(page 134\)](#) for more information.

**FEC Columns**

Specify the number of FEC columns in this field. Refer to [FEC Details \(page 134\)](#) for more information.

**Group Name**

The name of the encoder group.

**Enable Encoder Groups**

Click this toggle switch to enable (green) or disable encoder groups for the stream.

**Active**

Indicates if the encoder group is active. If active, this indicator will be green.

**Trigger**

Click this drop-down list to select the trigger type: **manual** or **input connected**.

**ACTIVATE**

Click this button to activate the encoder group.

**ADD**

Click this button to add the IP address of an encoder to the encoder group.

## Network page

The **Network** page provides the ability to enable or disable DHCP mode for each video channel. When DHCP mode is disabled, the IP address, subnet mask, and gateway must be provided. If using the dual-channel version, then the information on both Channel 1 and Channel 2 are provided. This screen is identical to the **Network** page for the decoder.

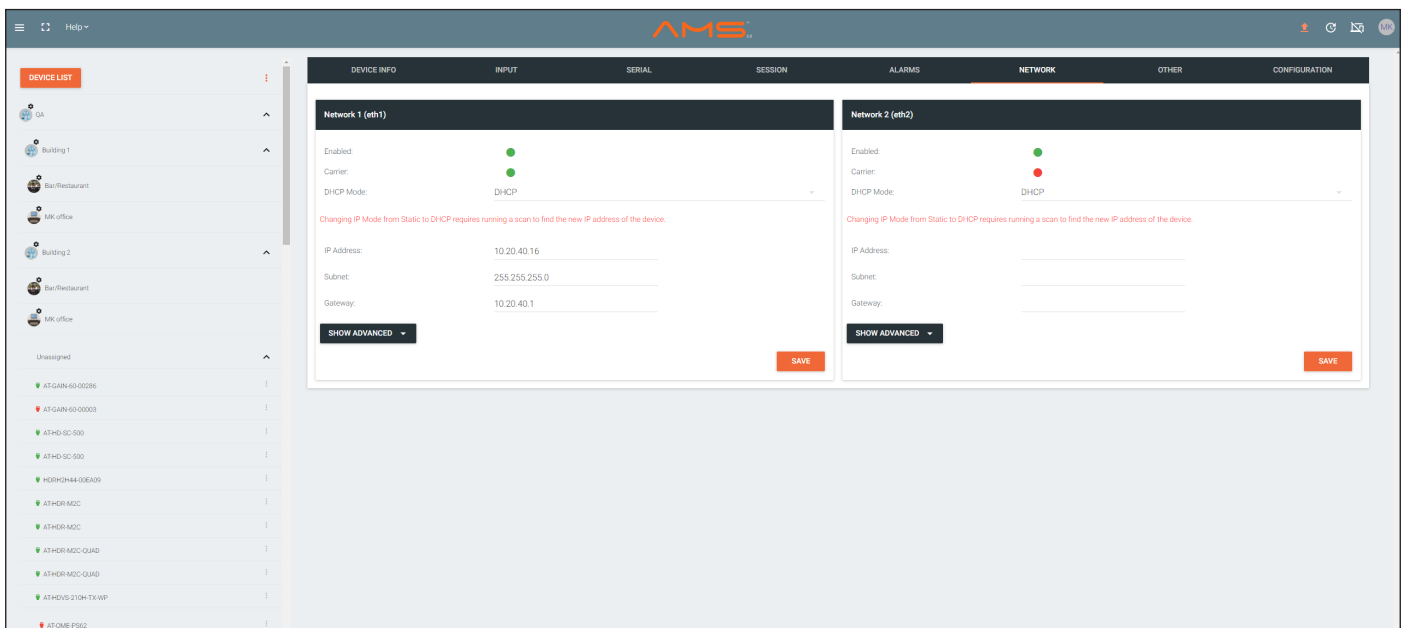

### Enabled

This indicator displays whether or not the video stream for this channel is active. If the indicator is green, then the video stream is active.

### Carrier

If this indicator is green, then an active link exists. Otherwise, if no link exists, this indicator will be red.

### DHCP Mode

Click this drop-down list to select the desired network mode. Select DHCP to let the DHCP server (if present) assign the encoder the IP settings; **Subnet** and **Gateway** fields will automatically be populated. When **Static** mode is selected, the information for the **IP Address**, **Subnet**, and **Gateway** fields must be entered.

### IP Address

Displays the IP address used by the channel. This field can only be changed if **Static** mode is selected.

### Subnet

Displays the subnet mask for the channel. This field can only be changed if **Static** mode is selected.

### Gateway

Displays the gateway (router) address for the channel. This field can only be changed if **Static** mode is selected.

### Advanced Settings

Click the **SHOW ADVANCED** button to view the following options.

#### Link Speed

Displays the port speed in Mbps.

#### MAC Address

The MAC address of the Ethernet channel.

#### Telnet Authentication

Click this toggle switch to enable or disable Telnet authentication. If enabled, then the toggle switch will be green. Once enabled, connecting to the encoder using Telnet will require login credentials. The default credentials are:

Username: admin  
Password: Atlona

#### 802.1x Mode

Click this drop-down list to select the desired authentication mode. Refer to [802.1X Authentication \(page 54\)](#) for more information.



## Other page

The **Other** page provides logo/slate, text, and PTP management. Click the menu in the upper-left corner of the AMS screen to switch between **Logo**, **Text**, and **PTP** screens.

### Logo

The **Logo** page provides the ability to upload a custom logo. This logo will be displayed when no video signal is detected. Separate logos can be uploaded: one for each channel. Refer to [Slate / Logo Insertion \(page 70\)](#) for more information on these settings.

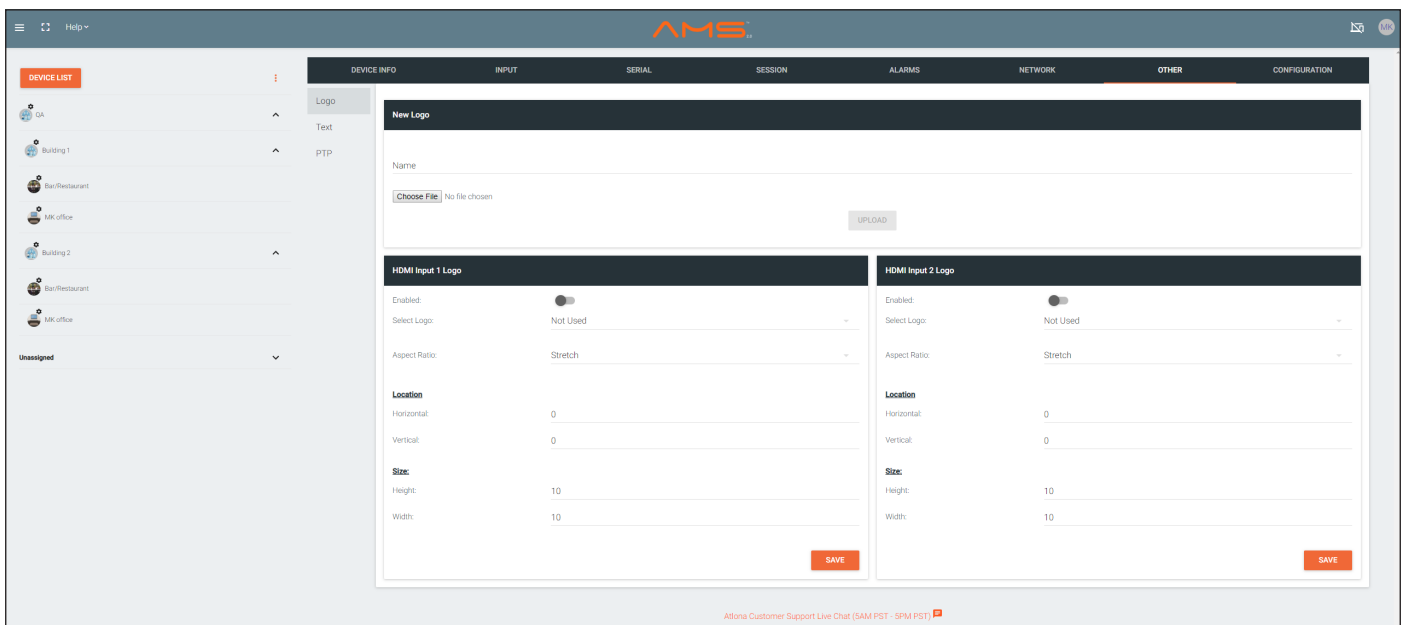

#### Name

Enter a name for the logo in this field.

#### Choose File

Click this button to select the logo file to be uploaded. Files must be in .png format and must not exceed 5 MB (5120000 bytes) in size. When an image file is uploaded, it will appear in the **Logo** drop-down list.

#### UPLOAD

Click this button to upload the logo file to the encoder.

#### Enabled

Click the toggle switch to enable or disable the logo. If the toggle switch is green, then the logo will be enabled.

#### Target

The name used by AMS to identify the encoder.

#### Select Logo

Click this drop-down list to select the desired logo. To disable the use of a logo, set to **Not Used**.

#### Aspect Ratio

Click this drop-down list to select the type of aspect ratio to be applied to the logo.

#### Horizontal

Enter the horizontal position of the logo on the screen.

## Vertical

Enter the vertical position of the logo on the screen.

## Height

Enter the horizontal resolution of the logo, in pixels.

## Width

Enter the vertical resolution of the logo, in pixels.



**IMPORTANT:** Maximum logo resolution (both height and width) is 1/4 of the video resolution.

## Text

The **Text** page provides the ability to display scrolling or stationary text superimposed on the source image. Refer to [Text Insertion \(page 74\)](#) for more information.

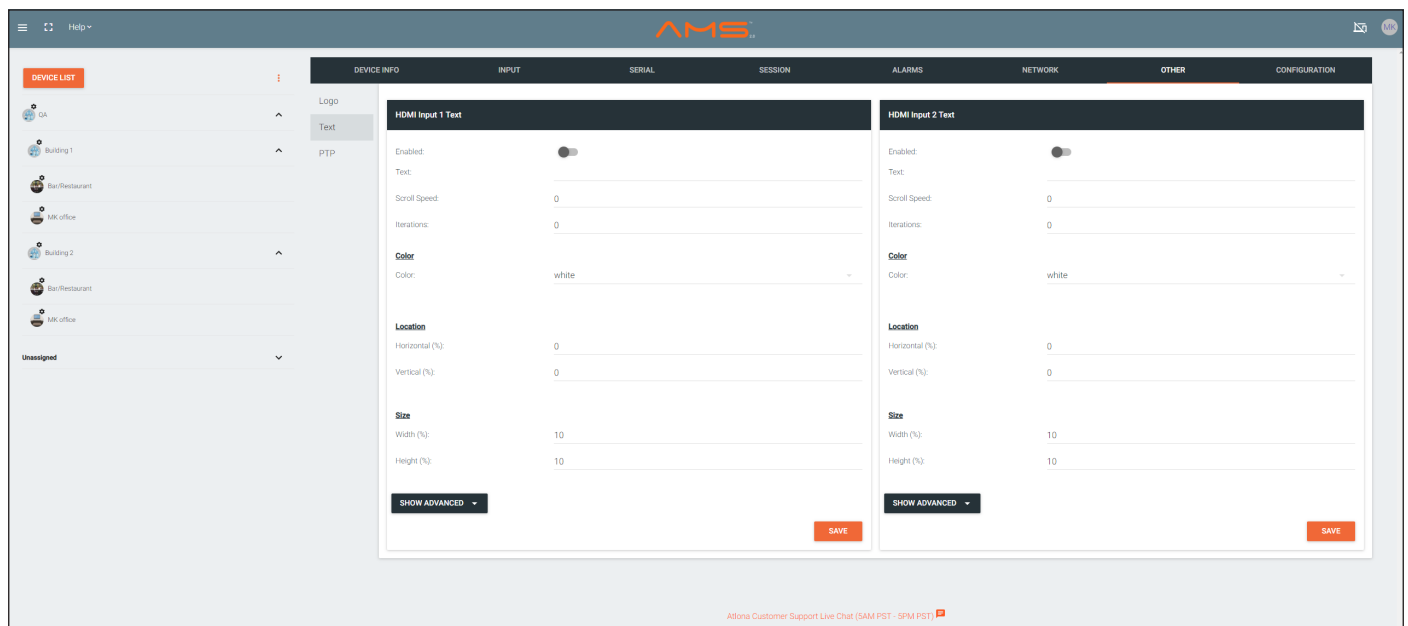

## Enabled

Click this toggle switch to enable or disable the text. When the toggle switch is green, the text will be enabled.

## Text

Enter the desired text in this field.

## Scroll Speed

Enter the scrolling speed in this field. Values from -255 to 255 are valid. Negative numbers will scroll the text from left to right. Positive numbers will scroll text from right to left.

## Iterations

Enter the number of iterations in the **Iteration** field. Set this field to 0 (zero) to set the number of iterations to infinity.

## Color

Click this drop-down list to select a solid color preset: **red, green, black, white, yellow, or blue.**

### Horizontal (%), Vertical (%)

Specify the location of the text in the Horizontal (%) and Vertical (%) fields. Each of these values is based on the horizontal and vertical resolution of the screen.

### Width (%), Height (%)

Specify the size of the text in the Width (%) and Height (%) fields. Each of these values is based on the horizontal and vertical resolution of the screen.

### Advanced Settings

Click the **SHOW ADVANCED** button to view the following options.

### Red, Green, Blue, Alpha

Enter the RGBA values for each of the respective fields, to specify a custom color and transparency of the text. Enter the desired value in the Alpha field to control the transparency of the text. A value of 255 is opaque and a value of 0 is transparent. Numbers from 0 to 255 are valid for each of these fields.

### PTP

The **PTP** page provides options to adjust Precision Time Protocol (PTP) for AES67 audio streams. PTP is used by AES67 to keep all audio streams synchronized.

For a system utilizing PTP, all devices undergo an automatic self-election process to choose the interface to be used as the PTP grandmaster (GM) clock, based on the accuracy of the device's clock and the device's configured priority. A lower priority number means the unit is more likely to get selected as GM.



**IMPORTANT:** If a new device is added to the network and the GM changes, a brief outage will be experienced while all connected devices synchronize with the new clock. Because of this, Atlona recommends that one unit gets manually defined as the GM and have both **Priority 1** and **Priority 2** fields be set to 1.

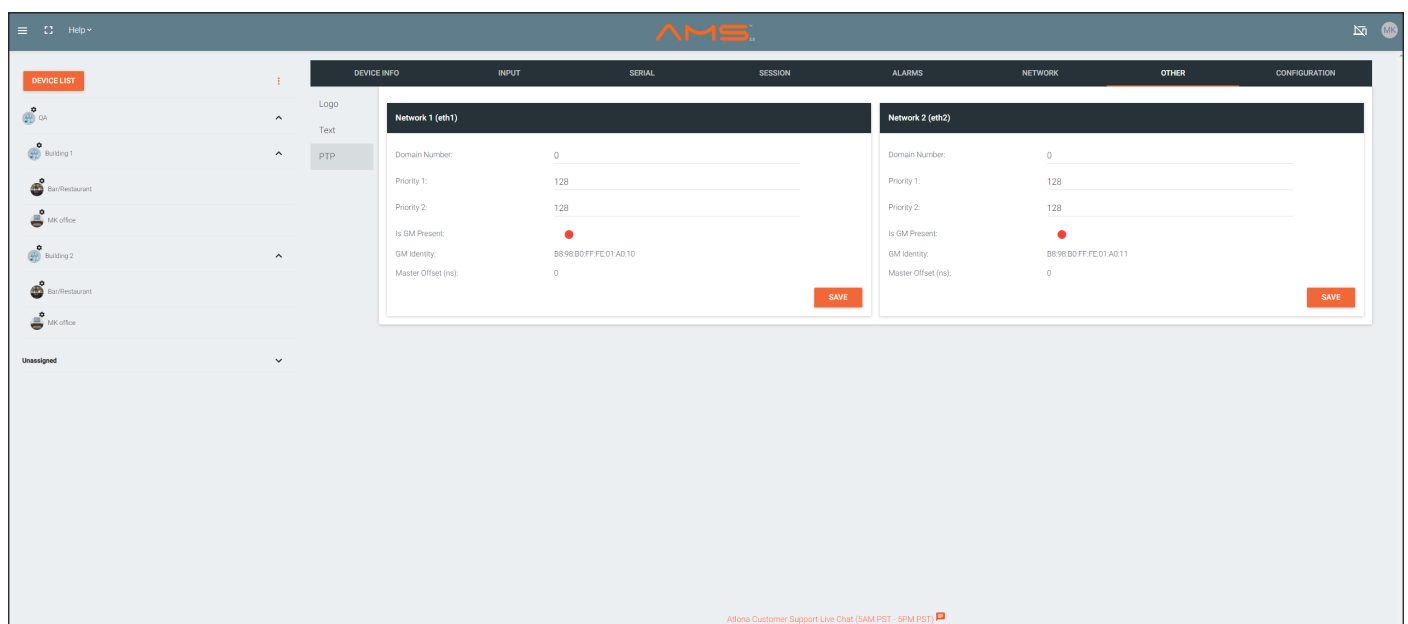

**Domain Number**

Enter the domain number in this field. Valid entries are 0 through 127.

**Priority 1**

Enter the priority number in this field.

**Priority 2**

Enter the priority number in this field.

**Is GM Present**

This indicator displays the existence of a grandmaster clock for the specified PTP domain number. If the indicator is green, then the grandmaster clock exists on this interface.

**GM Identity**

The grandmaster clock identity. If this field is blank, then it means that this interface is the grandmaster clock.

**Master Offset**

Displays the grandmaster clock offset.

## The Virtual Matrix

1. Login to AMS. Refer to **Accessing Encoders in AMS (page 16)**, if necessary.
2. Click the  icon, in the upper-left corner of the AMS Dashboard.
3. Click **Virtual Matrix**.

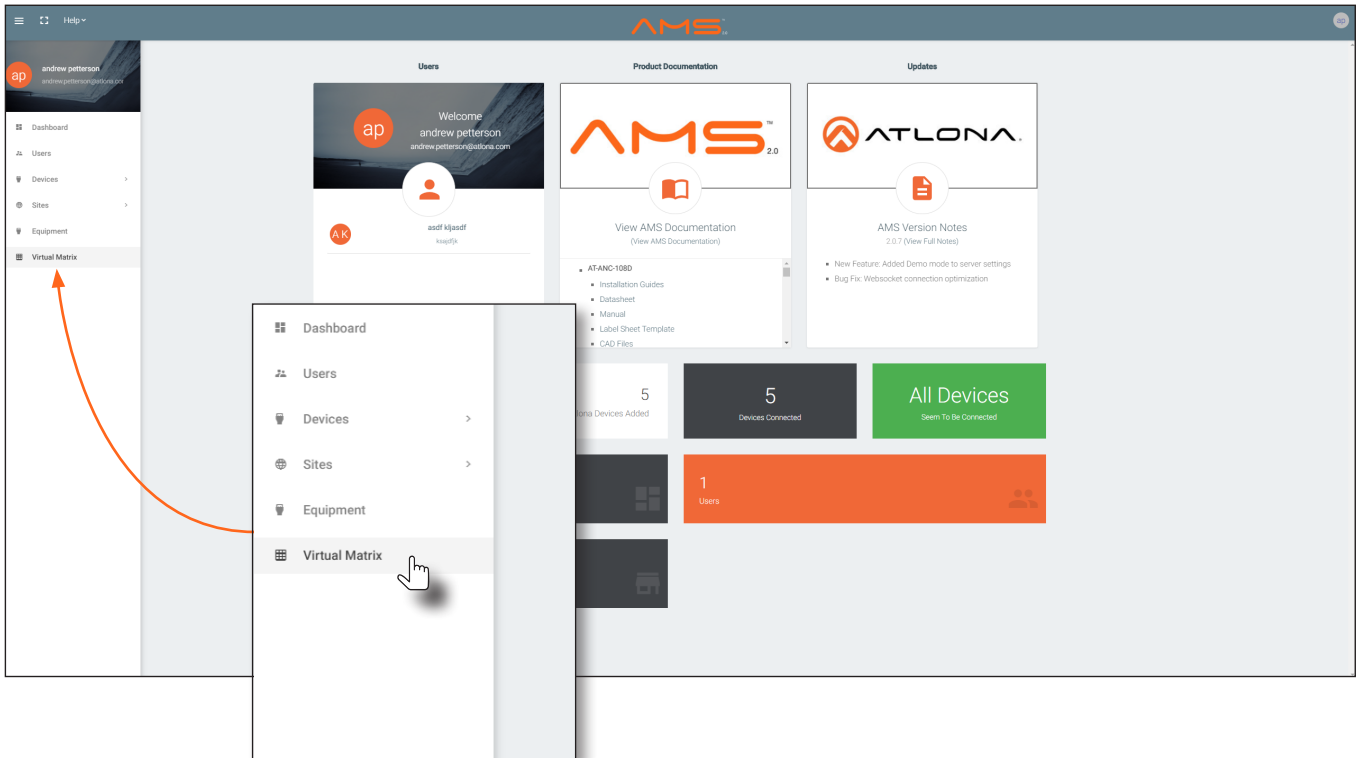

4. The **OmniStream Virtual Matrix** page will be displayed.



The screenshot shows the 'OmniStream Virtual Matrix' page. It displays a grid of encoder connections across multiple sites. The grid is organized into columns for different encoder models and rows for different sites. Each cell in the grid contains a status indicator (green checkmark for connected, blue checkmark for active, or a grid icon for disconnected) and a 'Legend' icon.

Encoders / Decoders	LEGEND	Andrew's AT-OMNI-122 192.168.11.181 at-omni-122-00048 Connected	AT-OMNI-121 192.168.11.134 at-omni-121-00045 Connected	AT-OMNI-122 192.168.11.85 192.168.11.87 at-omni-122-00242 Connected	AT-OMNI-521 192.168.11.29 at-omni-521-00054 Connected	AT-OMNI-122 192.168.11.160 192.168.11.161 at-omni-122-00081 Connected
AT-OMNI-112 192.168.11.89 192.168.11.88 at-omni-112-00249 Connected	HDMI 1 HDMI 2	✓	⊠	✓	⊠	✓
AT-OMNI-111 192.168.11.50 at-omni-111-00200 Connected	HDMI 1	⊠	⊠	⊠	⊠	⊠
AT-OMNI-512 192.168.11.51 at-omni-512-00200 Connected	HDMI 1 HDMI 2	⊠	✓	✓	⊠	⊠
Andrew's AT-OMNI-112 192.168.11.116 at-omni-112-00222 Connected	HDMI 1 HDMI 2	✓	⊠	✓	✓	✓
AT-OMNI-112 192.168.11.183 192.168.11.148 at-omni-112-00209 Connected	HDMI 1 HDMI 2	✓	⊠	✓	✓	✓

## Layout and Operation

The illustration below shows multiple OmniStream units (encoders and decoders). The Virtual Matrix is organized into rows and columns.

The blue circle with the check mark indicates that these two OmniStream units are connected to one another. The second column identifies a dual-channel decoder (AT-OMNI-122). The third row shows a dual-channel encoder (AT-OMNI-112). In this example, the source signal on **HDMI 1 IN** (encoder) is being sent out, over the network, and will be displayed on **HDMI 1** on the decoder. This will create a *cross-connection*, which connects both the encoder and decoder together.

- **Creating a cross-connection**

To route an input on an encoder to an output, locate the row and column where an input and output intersect, then click the square with the dots around it.

- **Removing a cross-connection**





To remove a *cross-connection*, click on the desired circle icon with the check mark symbol. The square with the dots around it will be displayed indicating that the *cross-connection* has been removed.

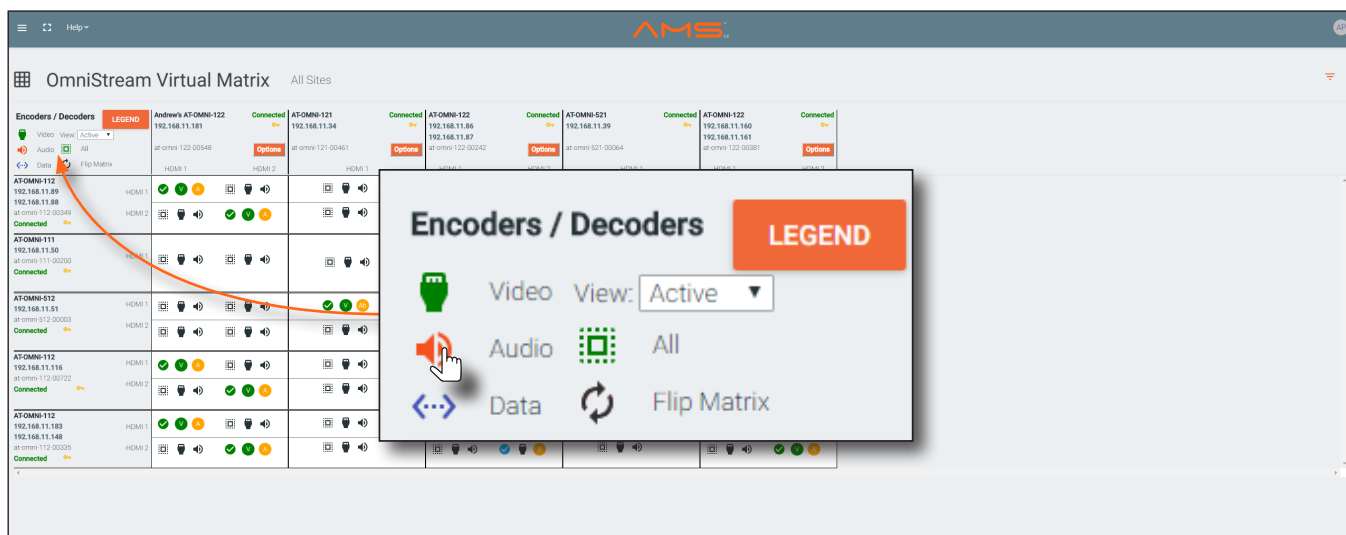

- To view the individual streams for video, audio, and data, click the icons on the upper-left corner of the screen.



When these icons are clicked, the associated icons will be displayed in the rows and columns of the Virtual Matrix.

Symbol	Description
	Video only
	Audio only
	Data only
	Connected; not all signals are active
	Connected; all streams are being used

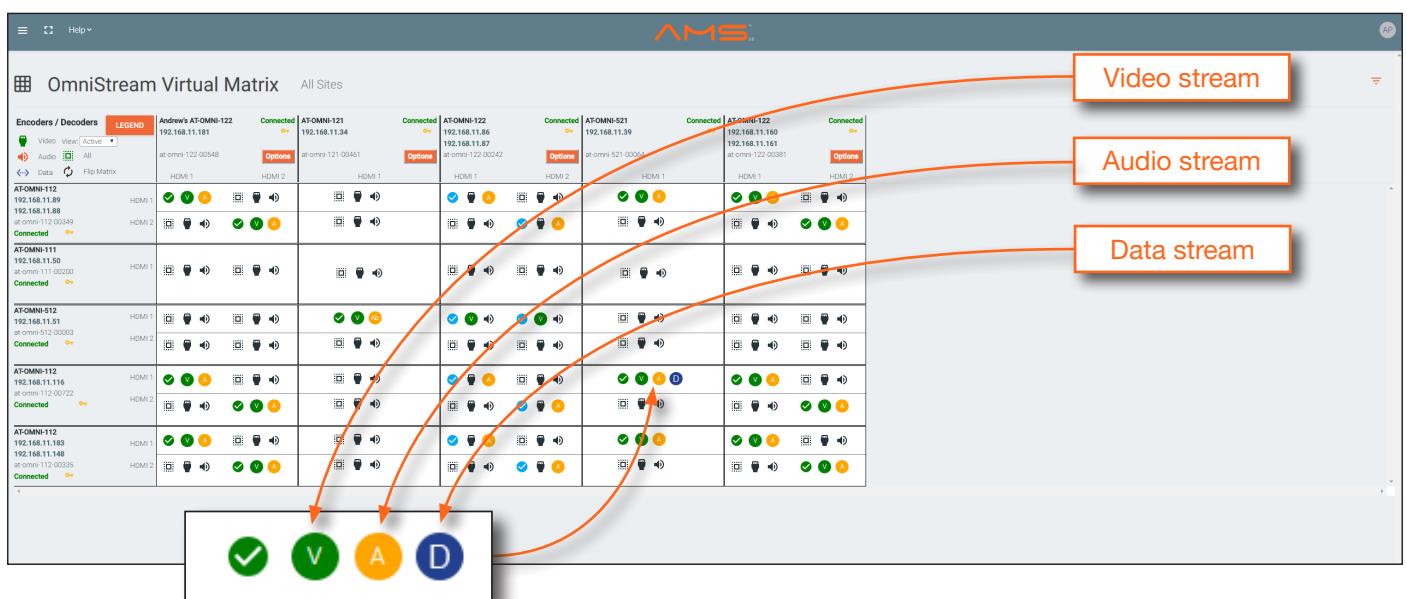

The screenshot shows the AMS interface with a grid of connections between encoders and decoders. The legend at the bottom indicates that the V icon represents Video only, the A icon represents Audio only, and the D icon represents Data only. The grid shows various connections between encoders and decoders, with callouts pointing to specific icons in the matrix grid.



**IMPORTANT:** R-Type and Pro compatibility: R-Type encoders (AT-OMNI-512) and decoders (AT-OMNI-521) operate in Video Mode, only. Pro encoders can be set to either Video Mode or PC Mode. Video Mode is incompatible with PC Mode. Therefore, in order for both R-Type and Pro encoders/decoders to work within a system, Pro encoders/decoders must be set to Video Mode. Refer to [Setting the Video Mode \(page 69\)](#) for more information.

- Click the **Video**, **Audio**, and **Data** icons to return to the normal view.
- Since only HDMI (both audio and video) is being used, the V (video) and A (audio) icons are displayed. The blue circle with the check mark indicates that the cross-section has been created. However, not all streams are being used. Refer to the chart below.
- This illustration also shows that the data stream (the icon with two arrows and three dots), which is used for control, is also being used and is displayed as a dark-blue circle with the letter “D”.
- The icons in the upper-left corner can also act as a filter. This allows for a clear breakdown of where signals are being routed and is useful when several encoders and decoders are used on a network.

# Web Server

## Accessing the Web Server

In order to access the web server of the desired encoder/decoder, the IP address of the encoder must be known. This can be accomplished by more than one method. Running IP scanner software or using the Address Resolution Protocol (ARP) are two possibilities. When running an IP scanner or using ARP, both the computer and the OmniStream encoders/decoders must be connected to the same network.



**TIP:** Atlona recommends downloading and using the Network Assignment Planner, when setting up OmniStream products on the network. Recording this information in this document will provide a “snapshot” of the current OmniStream network configuration. The Network Assignment Planner is available for download on the OmniStream product pages, under the Resources tab.

### Getting the IP Address

The following method uses the `arp` command, which is available from the command line in Windows. The `arp` command will display the IP-to-physical address translation tables used by the Address Resolution Protocol (ARP). The following procedure can be used for both encoders and decoders.

1. Identify the desired encoder/decoder by locating the MAC address on the bottom of the unit. *Figure 1.1* shows a sample label from an AT-OMNI-112 dual-channel encoder.

The MAC address for the Ethernet 1 physical interface is B8:98:B0:01:F7:EB.

*Figure 1.1 - Sample label on the bottom of a dual-channel encoder.*

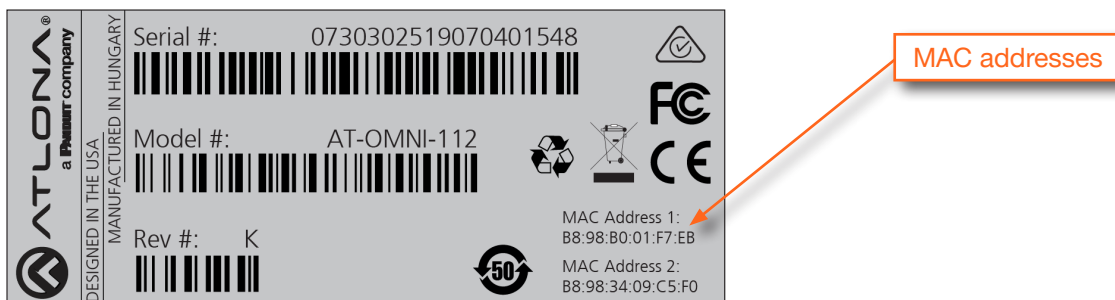

**NOTE:** Dual-channel encoders have two Ethernet interfaces and two MAC addresses:

Ethernet 1 = MAC address 1  
 Ethernet 2 = MAC address 2

Therefore, if *both* physical interfaces are connected to the network, the encoder will have two IP addresses. However, the same encoder can be accessed through either IP address.

2. Connect a PC to the same network where the OmniStream encoders/decoders are connected.
3. Type `cmd` in the search bar, then press [ENTER] to launch the command line interface.



- At the command prompt, type `arp -a`. Make sure to include a space between `arp` and the `-a` argument, then press [ENTER].
- Press [ENTER]. Several lines of information will be displayed. Locate the MAC address of the encoder/decoder, under the **Physical Address** column. Directly across from the MAC address, the IP address of the encoder/decoder will be listed under the **Internet Address** column.

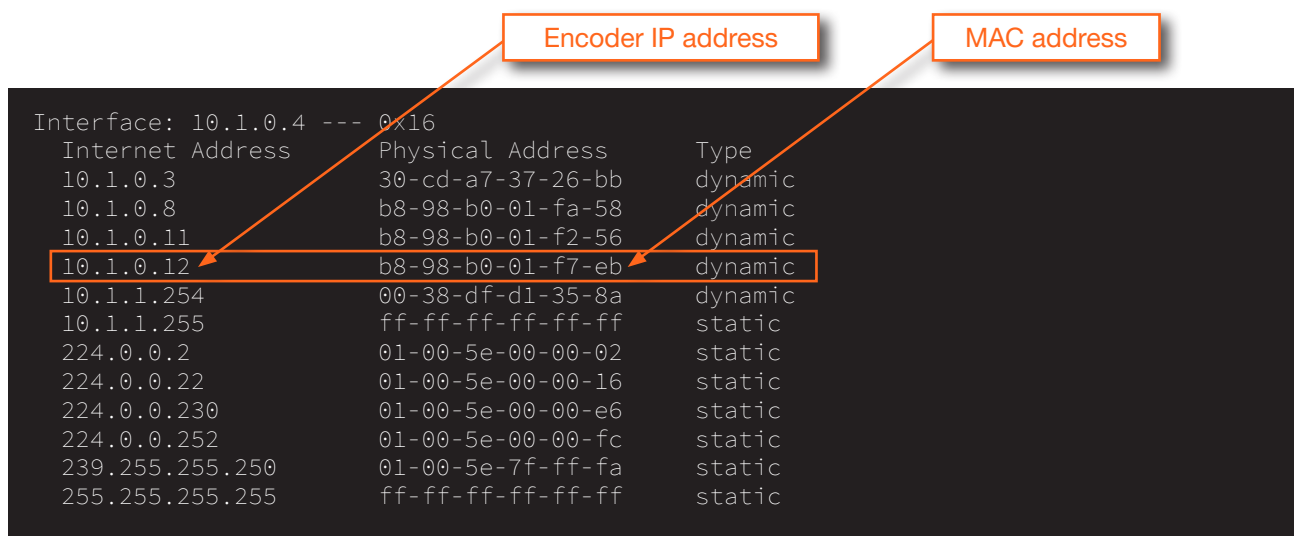

```

Interface: 10.1.0.4 --- 0x16
Internet Address      Physical Address      Type
10.1.0.3              30-cd-a7-37-26-bb    dynamic
10.1.0.8              b8-98-b0-01-fa-58    dynamic
10.1.0.11             b8-98-b0-01-f2-56    dynamic
10.1.0.12             b8-98-b0-01-f7-eb    dynamic
10.1.1.254            00-38-df-d1-35-8a    dynamic
10.1.1.255            ff-ff-ff-ff-ff-ff    static
224.0.0.2             01-00-5e-00-00-02    static
224.0.0.22            01-00-5e-00-00-16    static
224.0.0.230           01-00-5e-00-00-e6    static
224.0.0.252           01-00-5e-00-00-fc    static
239.255.255.250       01-00-5e-7f-ff-fa    static
255.255.255.255       ff-ff-ff-ff-ff-ff    static
  
```

## Logging In

- Launch the desired web browser and enter the IP address of the encoder in the address bar.
- Enter the username and password. Note that the password field will always be masked. The default credentials are:

Username: admin  
 Password: Atlona

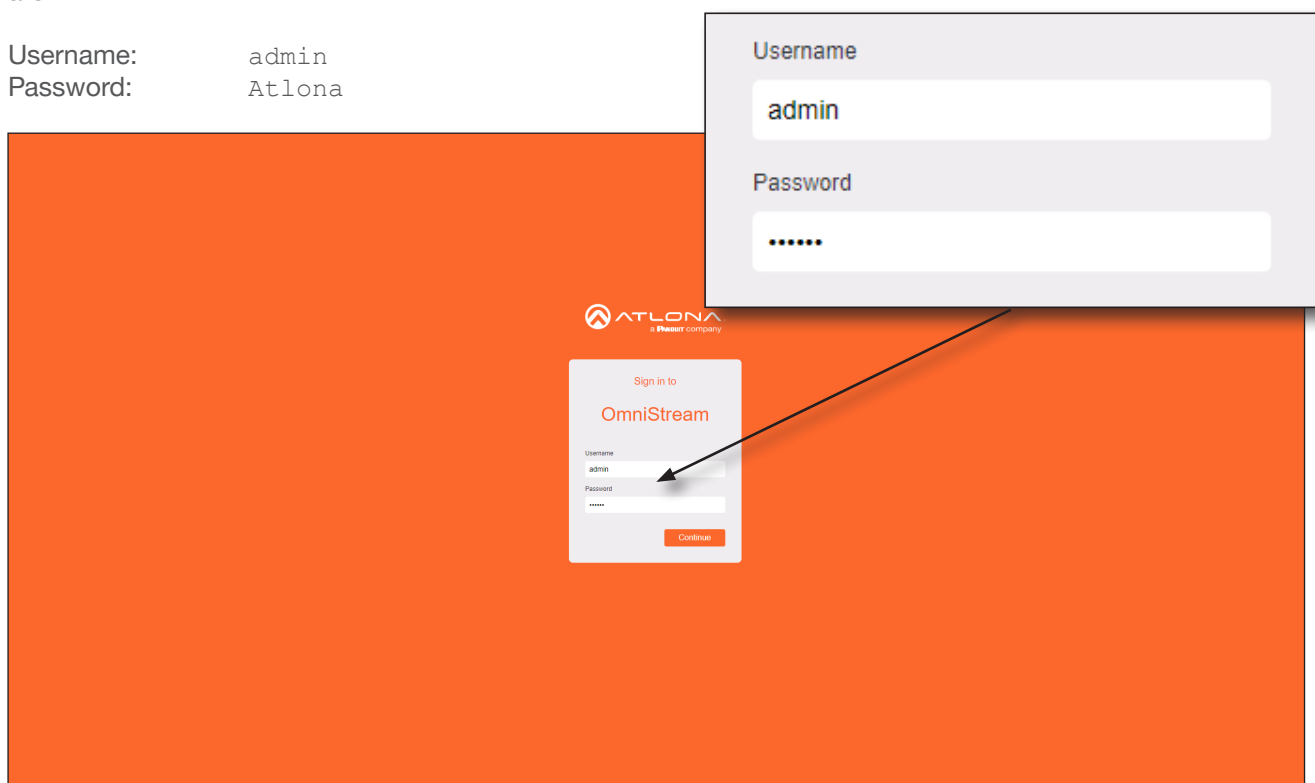

3. The **System Information** page will be displayed.

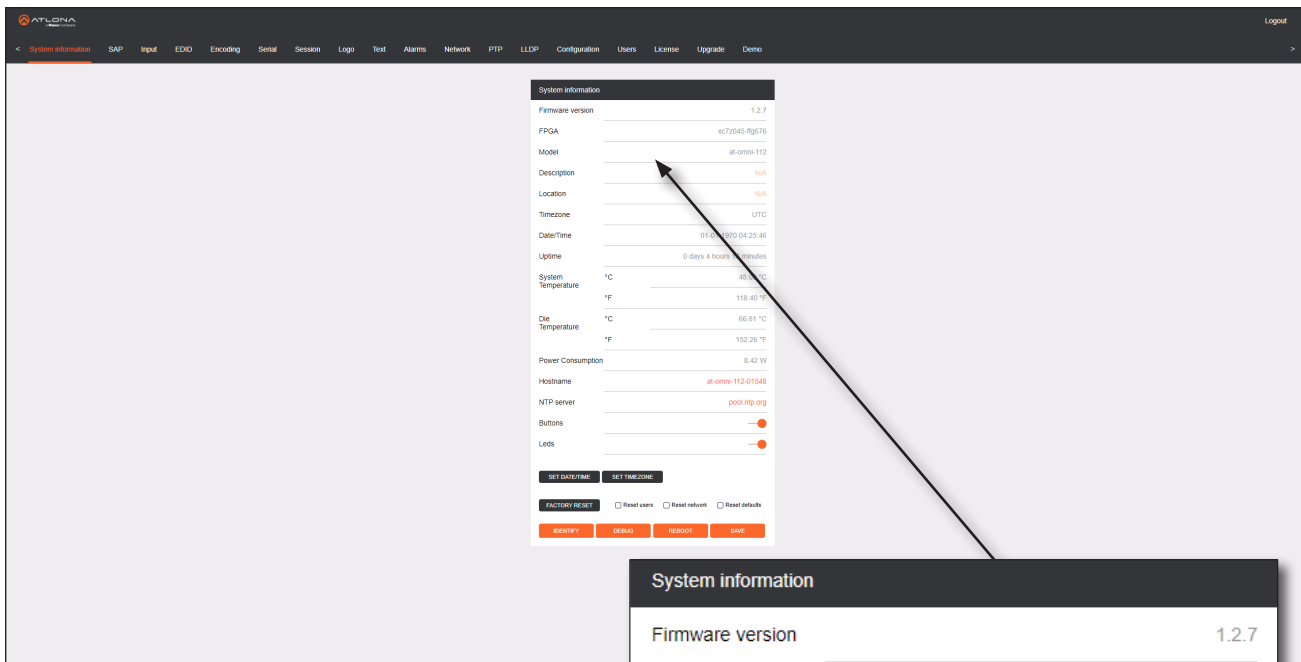

4. The login process is complete.

### System information

Firmware version	1.2.7
FPGA	xc7z045-ffg676
Model	at-omni-112
Description	N/A
Location	N/A
Timezone	UTC
Date/Time	01-01-1970 04:25:46
Uptime	0 days 4 hours 18 minutes
System Temperature	°C 48.00 °C °F 118.40 °F
Die Temperature	°C 66.81 °C °F 152.26 °F
Power Consumption	8.42 W
Hostname	at-omni-112-01548
NTP server	pool.ntp.org
Buttons	— ●
Leds	— ●

SET DATE/TIME
SET TIMEZONE

FACTORY RESET
 Reset users
  Reset network
  Reset defaults

IDENTIFY
DEBUG
REBOOT
SAVE

## System information page

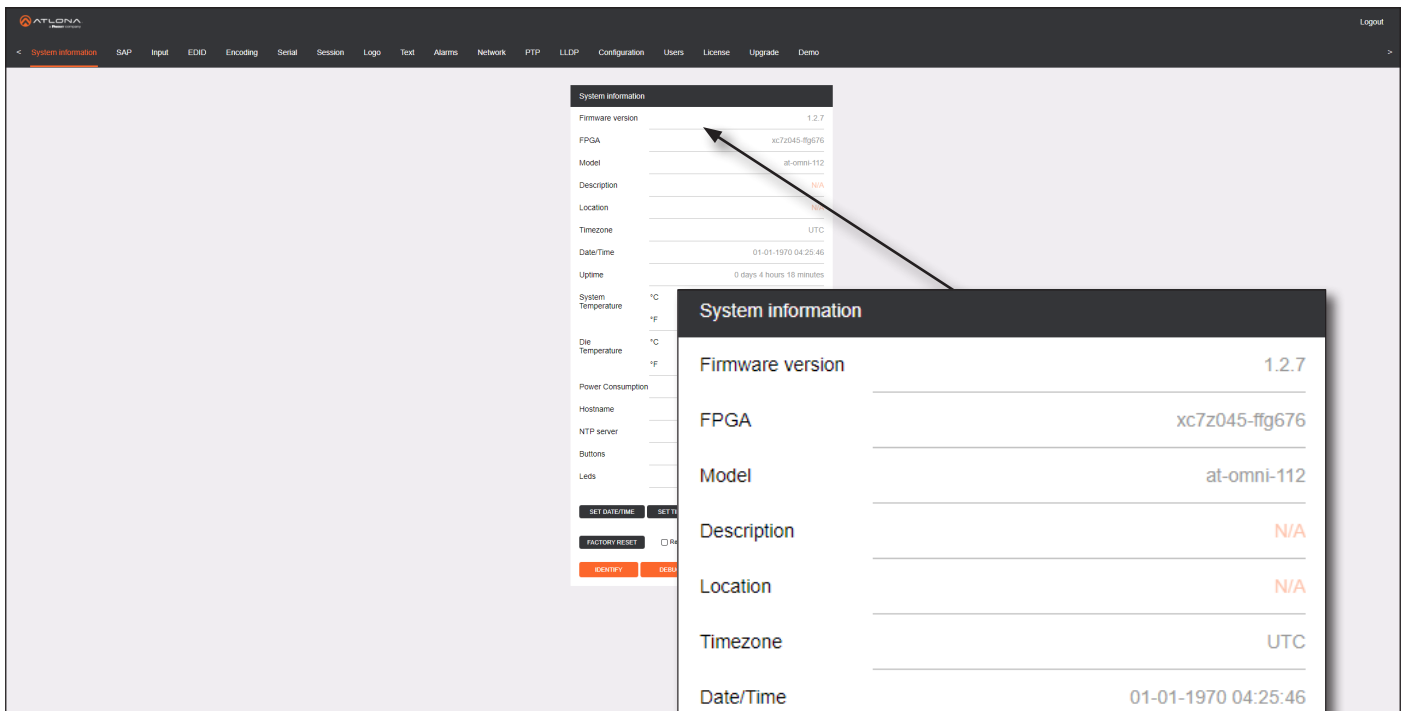
**Firmware version**

The version of firmware that the encoder is running. Always make sure the latest version of firmware is installed.

**FPGA**

Displays the FPGA model number and the size.

**Model**

The model number of the unit.

Model	Description
AT-OMNI-111	Single-channel encoder
AT-OMNI-112	Dual-channel encoder

**Description**

Provides the option of assigning descriptive name to the unit.

**Location**

Provides the option of assigning a description of where the unit is located.

**Timezone**

Displays the time zone format. Click the **SET TIMEZONE** button, to assign the time zone.

**Date/Time**

Displays the current date and time. Click the **SET DATE/TIME** button to set these values.

### System information

Firmware version	1.2.7
FPGA	xc7z045-ffg676
Model	at-omni-112
Description	N/A
Location	N/A
Timezone	UTC
Date/Time	01-01-1970 04:25:46
Uptime	0 days 4 hours 18 minutes
System Temperature	°C 48.00 °C °F 118.40 °F
Die Temperature	°C 66.81 °C °F 152.26 °F
Power Consumption	8.42 W
Hostname	at-omni-112-01548
NTP server	pool.ntp.org
Buttons	<input checked="" type="checkbox"/>
Leds	<input checked="" type="checkbox"/>

SET DATE/TIME
SET TIMEZONE

FACTORY RESET
 Reset users
  Reset network
  Reset defaults

IDENTIFY
DEBUG
REBOOT
SAVE

### Uptime

Displays the elapsed time since the unit was powered-on or rebooted.

### System Temperature

Displays the ambient enclosure temperature.

### Die Temperature

Displays the value returned from the die temperature sensor (DTS) on the chip of the PCB.

### Power Consumption

Displays the precise power consumption of the encoder.

### Hostname

Displays the hostname of the encoder. By default, OmniStream encoders are assigned a default hostname, which is constructed as follows: at-omni-[SKU]-[last five digits of MAC address]. If using a custom hostname, it must meet the hostname standards, defined here: <https://tools.ietf.org/html/rfc1123>.

### NTP Server

Displays the NTP server. This field is set to pool.ntp.org by default. Click this field to enter the desired NTP server address.

### Buttons

Click this toggle switch to enable or disable the button backlight indicators on the front-panel.

### Leds

Click this toggle switch to enable or disable all front-panel LED indicators and button backlight indicators.

### SET DATE/TIME

Click this button to set the current date and time.

### SET TIMEZONE

Click this button to set the desired time zone.

### FACTORY RESET

Click this button to reset the encoder to factory-default settings. When performing a factory reset, the following options can be selected, by clicking the check box. If no options are selected, then the encoder is reset with no factory-default settings.

Option	Description
None Checked	Resets the encoder with no factory-default settings.
Reset User	Resets the encoder to factory-default settings and resets custom user information.
Reset Network	Resets the encoder to factory-default settings and resets network information.
Reset Defaults	Resets the encoder to factory-default settings. In addition, static multicast addresses are configured. This option can be used to configure a single encoder to transmit to any number of decoders without using the Virtual Matrix within AMS.   <b>IMPORTANT:</b> This option will not work for multiple encoders on the same network.

**IDENTIFY**

Click this button to physically identify a unit on the network. Clicking this button will cause all front-panel LED indicators to flash for 10 seconds.

**DEBUG**

Click this button to instruct the unit to create a debug file. This file is used by Atlona Technical Support Engineers to diagnose internal issues with the unit.

**REBOOT**

Click this button to perform a soft reboot of the encoder.

**SAVE**

Click this button to commit changes to the settings on this page.

## SAP page

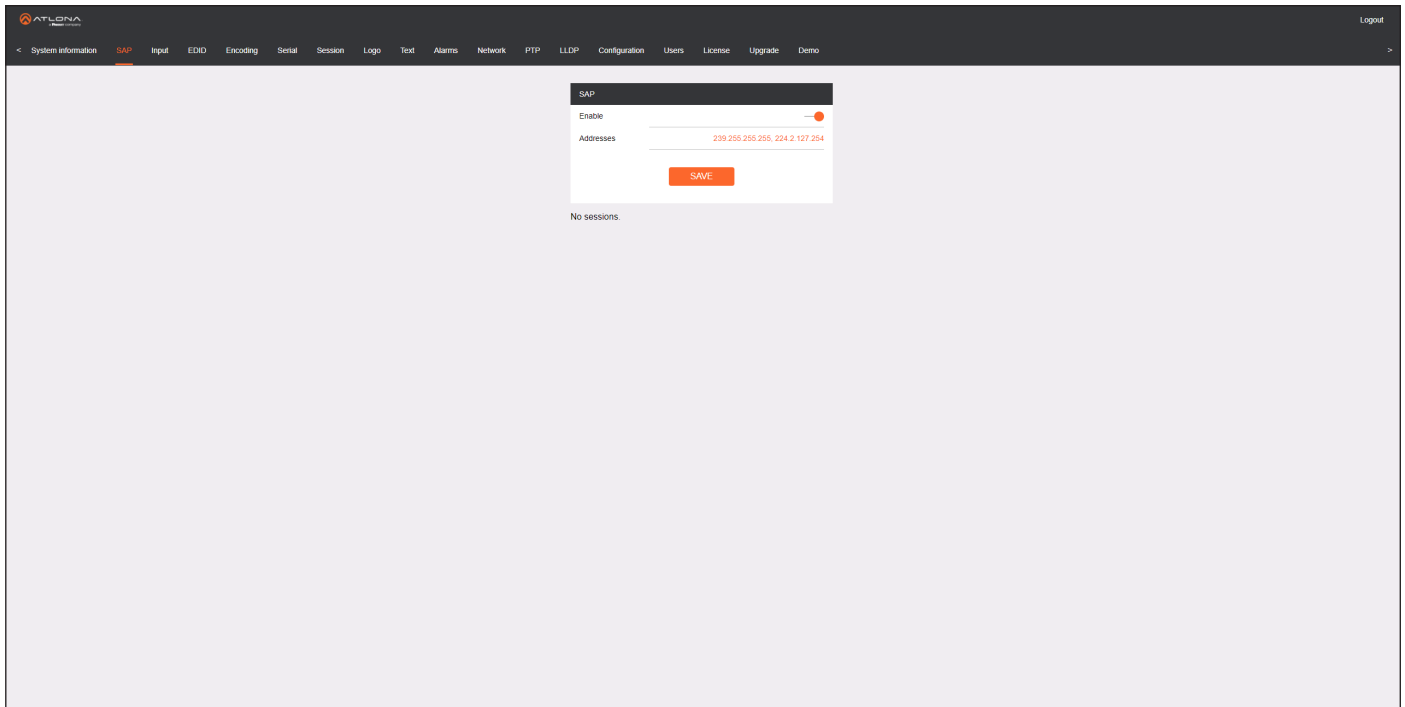

### Enable

Click this toggle to enable or disable SAP. This feature is enabled when the toggle switch is orange. This is the default setting.

### Addresses

Encoders currently send SAP announcements on two multicast addresses: 224.2.127.254 and 239.255.255.255. In some rare instances, this can conflict with other network address settings. Custom SAP addresses can be specified in this field.



**NOTE:** If the **Addresses** field is changed, then the same changes must be applied to all devices, in order for all devices to see the SAP multicast.

Input page

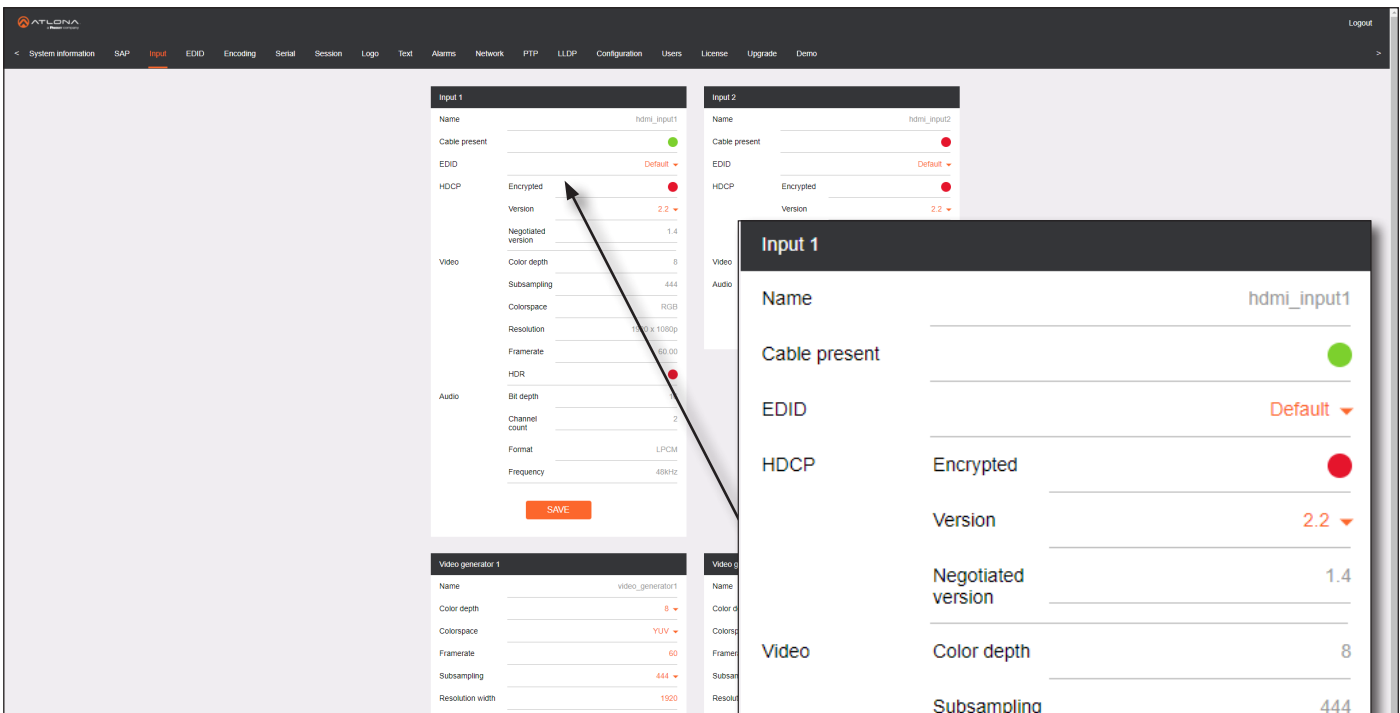

Input window groups

The following fields apply to both the **Input 1** and **Input 2** window groups. Single-channel encoders only have a single **Input** window group.

**Name**

The name of the input. This field cannot be changed.

**Cable present**

This indicator will be red if the encoder is unable to detect the source signal. This may indicate a damaged HDMI cable. If this indicator is green (shown), then the cable integrity is good, and additional fields for both the Video and Audio sections will be displayed.

**EDID**

Click this drop-down list to select the desired EDID. The default EDID is selected as a default setting.

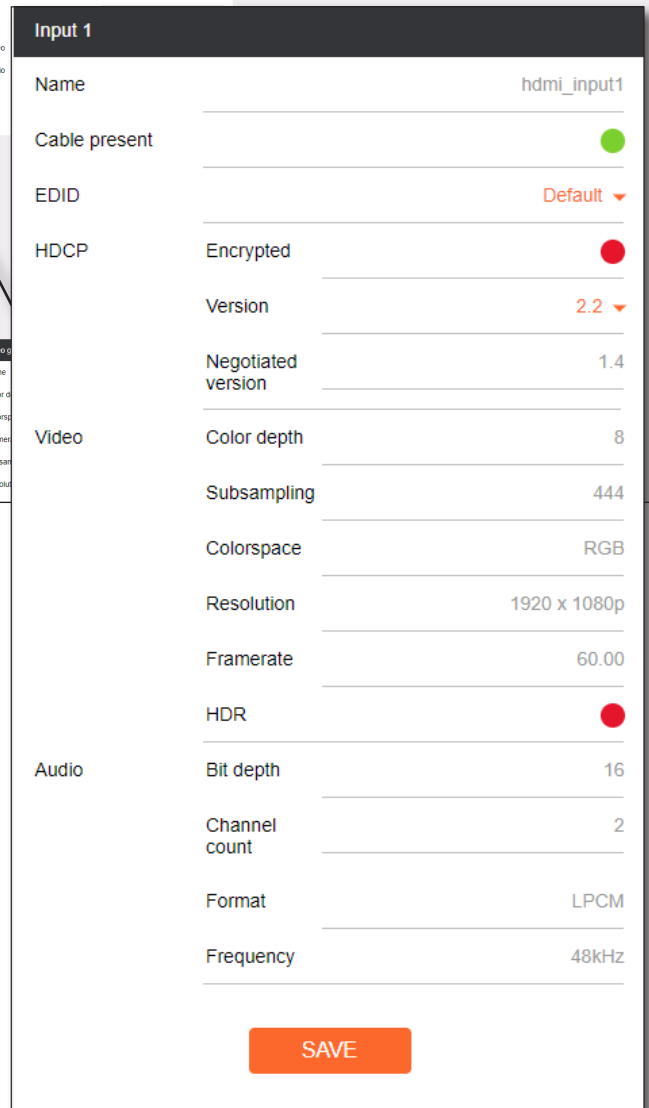

EDID	Description
Default	Default EDID (3840x2160p30)
Default (DV)	Default EDID with Dolby Vision (3840x2160p30)
ATL 1080P 2CH	1920x1080p60 with two-channel PCM audio
ATL 1080P DD	1920x1080p60 with Dolby Digital
ATL 1080P DVI	1920x1080p60 formatted as DVI
ATL 1080P MCH	1920x1080p60 with multichannel audio
ATL 1280x800 RGB DVI PCWXGADVI	1280x800 formatted as DVI
ATL 1280x800 RGB PCWXGA2CH	1280x800p60 PC format with two-channel PCM audio
ATL 1280x800 RGB TVWXGA2CH	1280x800p60 TV format with two-channel PCM audio

EDID	Description
ATL 2160P 2CH	3840x2160p30 with two-channel PCM audio
ATL 2160P MCH	3840x2160p30 with multichannel PCM audio
ATL 2560x1600 2CH	2560x1600p60 with two-channel PCM audio
ATL 2560x1600 MCH	2560x1600p60 with multichannel PCM audio
ATL 720P DD	1280x720p60 with Dolby Digital audio
ATL 720P 2CH	1280x720p60 with Dolby Digital two-channel audio
ATL VR (2160x1200)	2160x1200p90 (Compatible with HTC VIVE® VR system)

## HDCP

### Encrypted

Indicates if the content being transmitted from the source is HDCP-encrypted. If using HDCP-encrypted content is being used, then this indicator will be green.

### Version

Click this drop-down list to select the version of HDCP to be supported: **2.2**, **1.4**, or **None**. If **None** is selected, then HDCP-encrypted content cannot be passed-through.

## Video

The following fields will only be displayed if the **Cable present** indicator is green.

### Color Depth

Displays the color depth of the source content.

### Subsampling

Displays the chroma subsampling value of the source content.

### Colorspace

Displays the color space of the source content.

### Resolution

Displays the resolution of the source content.

### Framerate

Displays the frame rate of the source content.

### HDR

This indicator displays the presence of HDR source content. If the indicator is green, then the source is outputting HDR content. If the indicator is red, then no HDR content is detected.

## Audio

The following fields will only be displayed if the **Cable present** indicator is green.

### Bit Depth

Displays the bit depth of the source audio.

### Channel count

Displays the number of audio present that are present in the source audio.

### Format

Displays the audio format of the source content.

### Frequency

Displays the audio frequency of the source content.



**Video generator 1**

Name	video_generator1
Color depth	8 ▼
Colorspace	YUV ▼
Framerate	60
Subsampling	444 ▼
Resolution width	1920
Resolution height	1080

### Video generator window groups

The following fields apply to both the **Video generator 1** and **Video generator 2** window groups. This signal can be used to test the video capability of the network. Single-channel encoders will have one **Video generator** window group.

#### Name

The name of the input. This field cannot be changed.

#### Color Depth

Click this drop-down list to select the color depth. Available values are 8, 10, and 12.

#### Colorspace

Click this drop-down list to select the color space. Available values are YUV and RGB.

#### Framerate

Click in this field to change the frame rate of the video generator signal. The default value is 60 Hz.

#### Subsampling

Click this drop-down list to select the chroma subsampling value. Available values are 444, 442, and 420.

#### Resolution width

Click in this field to change the horizontal resolution of the signal.

#### Vertical width

Click in this field to change the vertical resolution of the signal.

EDID page

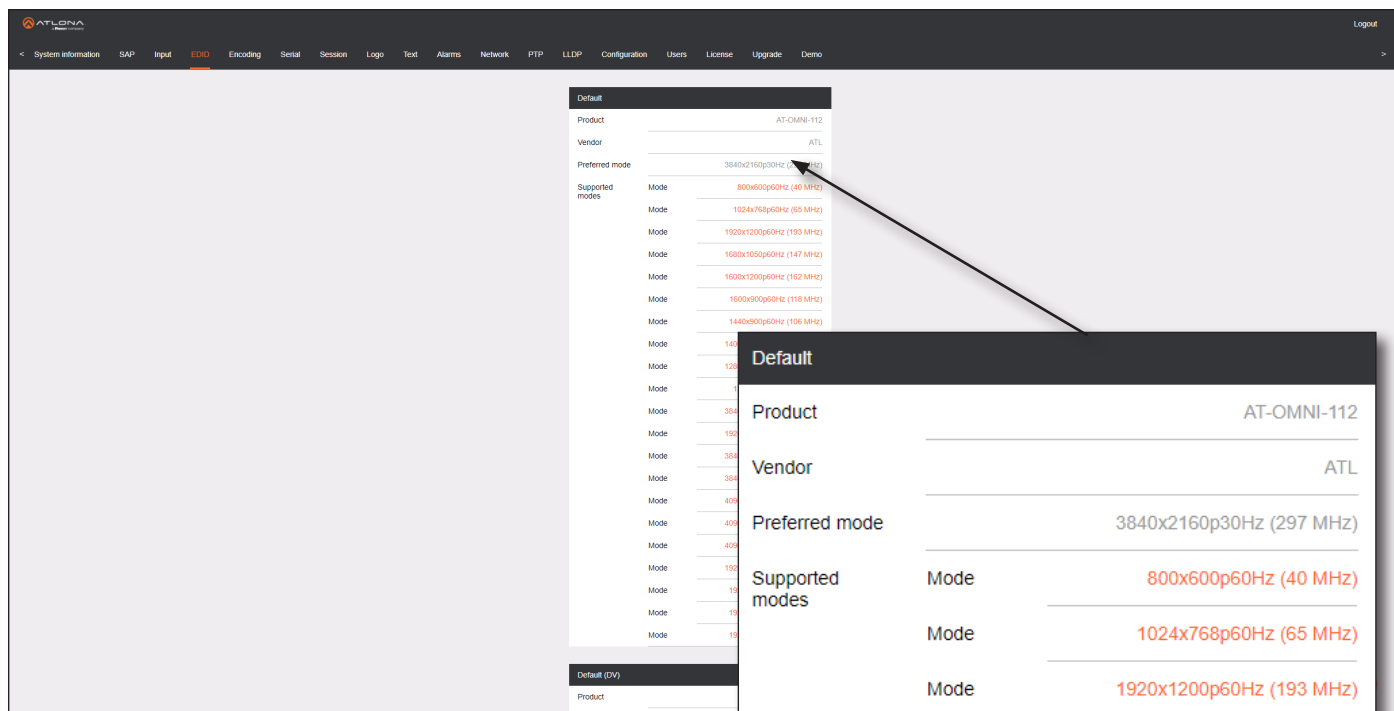

**Product**

Displays the SKU of the OmniStream encoder. This field cannot be changed.

**Vendor**

Displays the vendor name (ATL). This field cannot be changed.

**Preferred mode**

Displays the preferred timing and resolution of the EDID. This field cannot be changed.

**Supported modes**

**Mode**

In addition to the preferred timing and resolution, each EDID structure contains a listing of supported timings/resolutions. The number of available supported timings/resolutions depends on the EDID.

**Add EDID**

Click this button, located at the bottom-right of the page, to create a new EDID.



**Default**

**Product** AT-OMNI-112

**Vendor** ATL

**Preferred mode** 3840x2160p30Hz (297 MHz)

**Supported modes**

Mode	800x600p60Hz (40 MHz)
Mode	1024x768p60Hz (65 MHz)
Mode	1920x1200p60Hz (193 MHz)
Mode	1680x1050p60Hz (147 MHz)
Mode	1600x1200p60Hz (162 MHz)
Mode	1600x900p60Hz (118 MHz)
Mode	1440x900p60Hz (106 MHz)
Mode	1400x1050p60Hz (122 MHz)
Mode	1280x1024p60Hz (108 MHz)
Mode	1280x800p60Hz (83 MHz)
Mode	3840x2160p30Hz (297 MHz)
Mode	1920x1080p60Hz (148 MHz)
Mode	3840x2160p25Hz (297 MHz)
Mode	3840x2160p24Hz (297 MHz)
Mode	4096x2160p30Hz (297 MHz)
Mode	4096x2160p25Hz (297 MHz)
Mode	4096x2160p24Hz (297 MHz)
Mode	1920x1080p50Hz (148 MHz)
Mode	1920x1080p30Hz (74 MHz)
Mode	1920x1080p25Hz (74 MHz)
Mode	1920x1080p24Hz (74 MHz)

## Encoding page

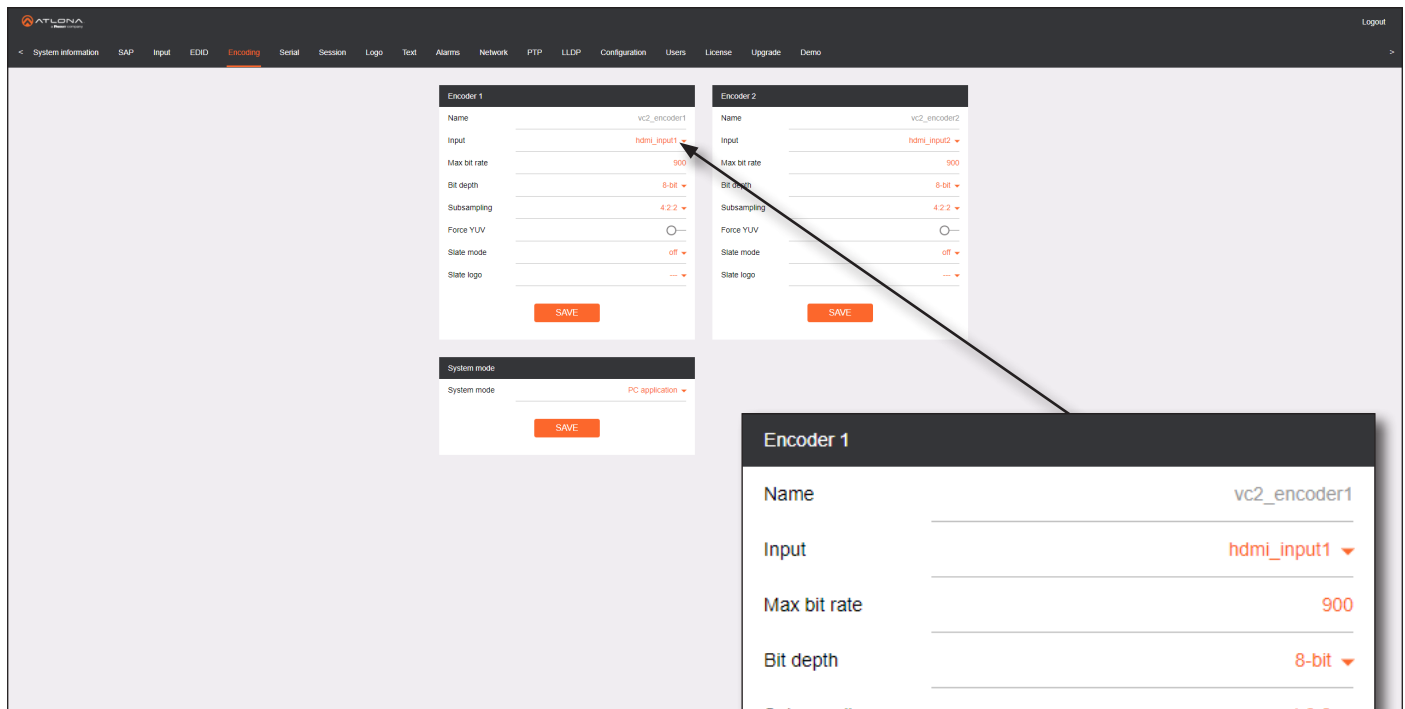

### Encoder window groups

The following fields apply to both the **Encoder 1** and **Encoder 2** window groups. Single-channel encoders will have one **Encoder** window group.

#### Name

The name of the encoder. This field cannot be changed.

#### Input

Click this drop-down list to select the input. Available options are: **not used**, **hdmi\_input1**, **hdmi\_input2**, **video\_generator1**, and **video\_generator2**. Single-channel encoders will only have the following options: **not used**, **hdmi\_input1**, and **video\_generator1**.

#### Max bit rate

Click this field to enter the maximum bit rate. The default setting is **900** Mbps. Specifying lower bit rates will reduce video quality. 4K/UHD streams should be set to 900 Mbps. The recommended bandwidth for 1080p60 video is 450 Mbps. Setting this field below these recommended values will result in lower-quality video.

#### Bit depth

Click in this drop-down list to select the desired bit depth. Available values are: **8-bit**, **10-bit**, and **12-bit**.

#### Subsampling

Click this drop-down list to select the chroma subsampling value. Available values are: **4:4:4**, **4:4:2**, and **4:2:0**.

#### Force YUV

When this toggle switch is enabled (green), the encoder will stream YUV content over the network, regardless of which color space is used by the HDMI source. When the decoder receives the YUV stream, it will output YUV on the HDMI output. However, if the decoder is connected to a display that requires RGB, as determined by the EDID of the display, then the decoder will convert the video signal to RGB on the HDMI output. In order for the chroma scaling to work on RGB inputs, this option must be enabled.

### Slate mode

Click this drop-down list to enable or disable slate mode. Available values are: **off**, **manual**, and **auto**.

Mode	Description
Off	Disables the image from being displayed.
Manual	The image will always be displayed, superimposed on the source signal, and will remain even if the source signal is lost.
Auto	The image will only be displayed when the source signal is lost. For example, this mode is useful in conference room applications for displaying system instructions when no sources are connected.

### Slate logo

Click this drop-down list to select the desired slate logo.

### System mode

#### System mode

Click this drop-down list to select **PC application** or **Video** mode. By default, units are set to **PC Application** mode.

System mode

System mode PC application ▼

---

SAVE



**IMPORTANT:** If decoders are configured to be used in a video wall application, then Force YUV must be enabled.

Mode	Description
PC Application	Optimizes the image when viewing static images, such as spreadsheets or similar content.
Video	Provides the best viewing experience when streaming motion graphics and/or video.

## Serial page

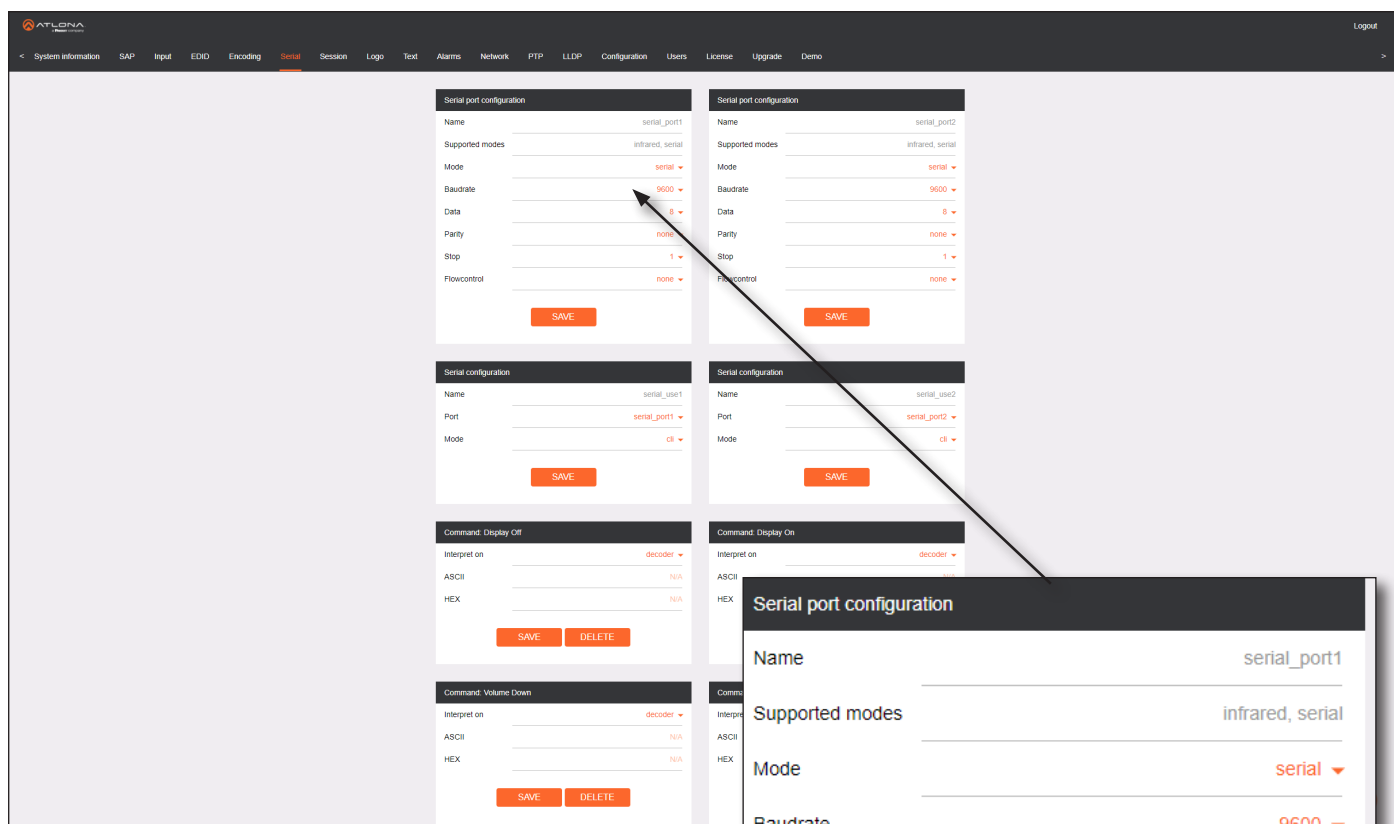

### Serial port configuration window groups

The following fields apply to both **Serial port configuration** window groups. Although single-channel encoders will also have two **Serial port configuration** window groups, serial port 2 only supports IR.

#### Name

The name of the serial port. This field cannot be changed.

#### Supported Modes

Displays the supported protocols for the serial port. This field cannot be changed.

#### Mode

Click this drop-down list to select the desired serial mode. Available values will be reflected in the **Supported Modes** field.

#### Baudrate

Click this drop-down list to select the desired baud rate: **115200, 57600, 38400, 19200, or 9600.**

#### Data

Click this drop-down list to select the number of data bits: **6, 7, or 8.**

#### Parity

Click this drop-down list to select the parity bit: **None, Odd, Even, Mark, or Space.**

#### Stop

Click this drop-down list to select the stop bit: **1, 1.5, or 2.**

## Flow Control

Click this drop-down list to select the type of flow control: **none**, **xonxoff**, or **hw**.

## SAVE

Click this button to commit all changes within the **Serial port configuration** window group.

## Serial configuration window groups

The following fields apply to both **Serial configuration** window groups. The single-channel encoder will only have one **Serial configuration** window group.

### Name

The name of the port. This field cannot be changed.

### Port

Click this drop-down list to select the desired serial port.

### Mode

Click this drop-down list to select the desired control mode. Available values are: **cli** and **tcpproxy**. Select **tcpproxy** to send IP commands directly to the decoder, which are then output over RS-232 to the display (sink) device. Selecting the **cli** option will pass through RS-232 data, directly from a control system, to the sink device that is connected to the decoder.

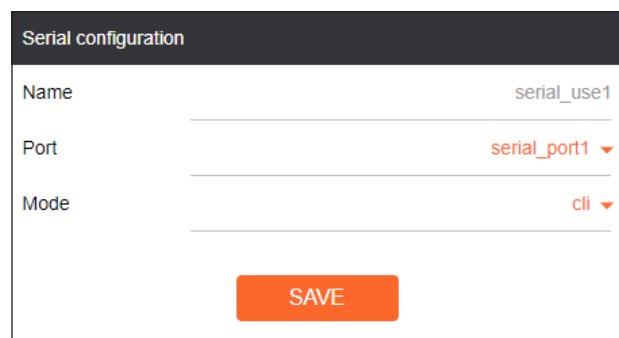

Serial configuration	
Name	serial_use1
Port	serial_port1 ▼
Mode	cli ▼
<input type="button" value="SAVE"/>	

## SAVE

Click this button to commit all changes within the **Serial configuration** window group.

## Command window groups

By default, window groups for the following commands are created: **Display Off**, **Display On**, **Volume Down**, and **Volume Up**.

### Interpret on

Click this drop-down list to select the endpoint where the command will be processed: **encoder** or **decoder**.

### ASCII

Enter the ASCII representation of the command string in this field.

### HEX

Enter the hexadecimal representation of the command in this field.

## SAVE

Click this button to commit all changes within the **Command** window group.

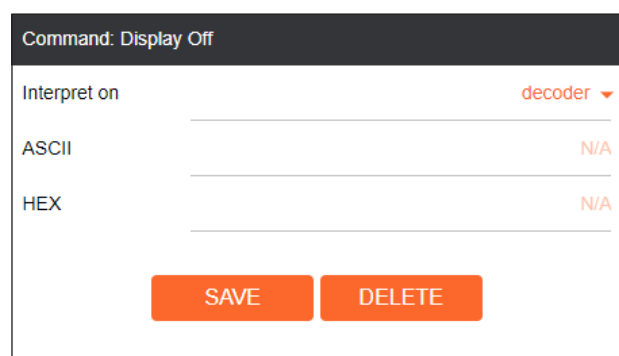

Command: Display Off	
Interpret on	decoder ▼
ASCII	N/A
HEX	N/A
<input type="button" value="SAVE"/> <input type="button" value="DELETE"/>	



**NOTE:** When entering the command string, it is not required to enter the string under both the ASCII and HEX fields. The encoder requires that one field be completed.



### New Command

Click this button to create a new command window group. Provide a name for the command in the displayed dialog box, then click the **Create** button. Complete each of the fields, as described above.

## Session page

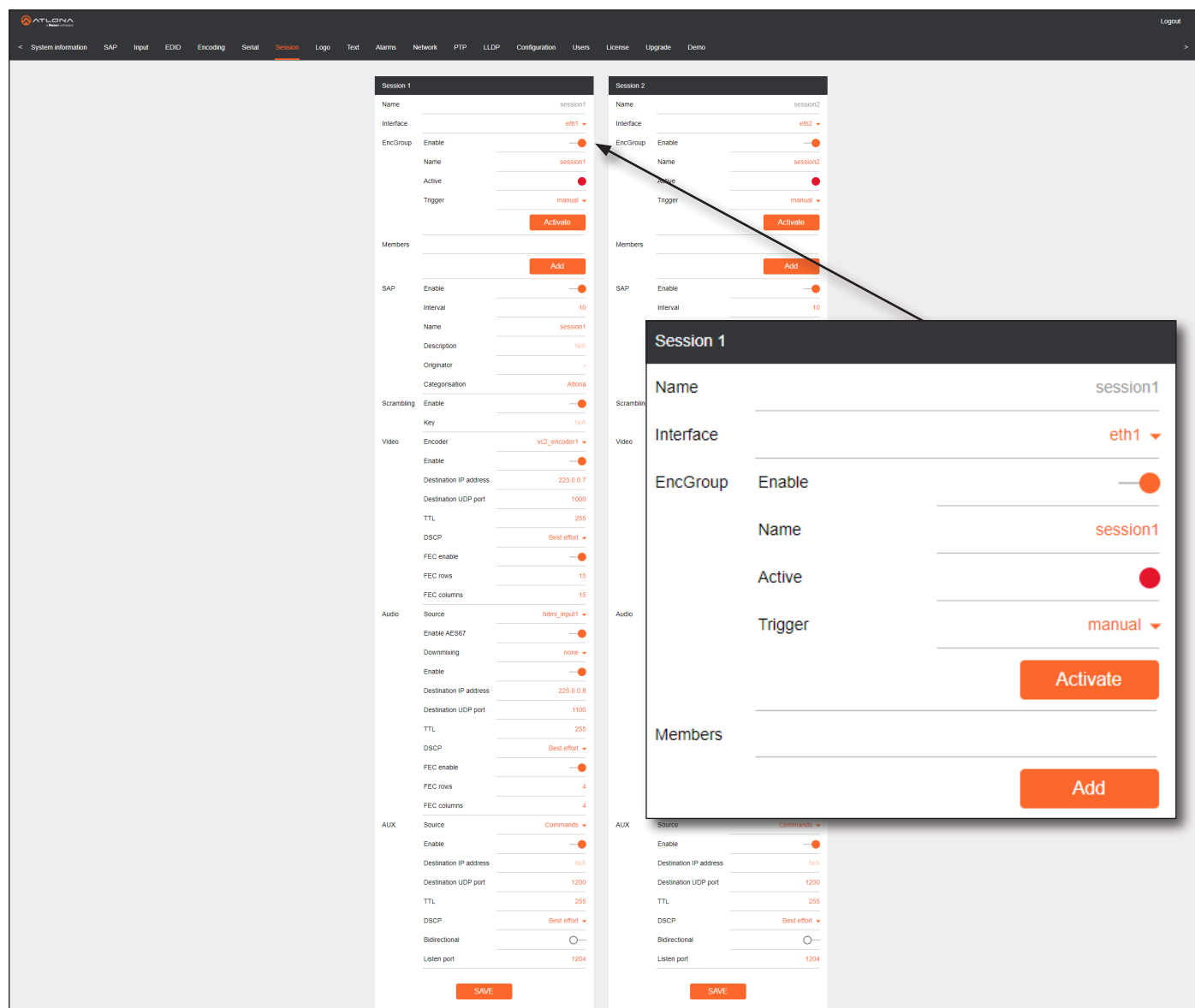

The screenshot displays the ATLONA web interface for configuring sessions. It shows two session configuration panels, Session 1 and Session 2, with various settings like Name, Interface, EncGroup, Name, Active, Trigger, Members, SAP, Scrambling, Video, Audio, and AUX. A modal window for Session 1 is overlaid, providing a detailed view of its configuration, including fields for Name, Interface (eth1), EncGroup (Enable), Name (session1), Active (radio button), Trigger (manual), and an Activate button. There is also an Add button for members.

### Session window groups

The following fields apply to all **Session** window groups. The dual-channel encoder has six **Session** window groups. The single-channel encoder will only have two **Session** window groups.

#### Name

The name of the session. This field cannot be changed.

#### Interface

Click this drop-down list to select the desired interface.

Interface	Description
eth1	ETHERNET 1 port
eth2	ETHERNET 2 port

## EncGroup

### Enable

Click this toggle switch to enable (orange) or disable encoder grouping.

### Name

Enter the name of the encoder in this field. Only available if encoder grouping is enabled.

### Active

Indicates if the encoder group is active. If active, then this indicator will be green. Only available if encoder grouping is enabled.

### Trigger

Click this drop-down list to select the trigger type: **manual** or **input connected**. Only available if encoder grouping is enabled.

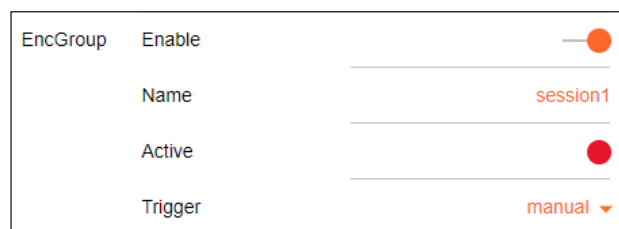

A screenshot of the EncGroup configuration form. It includes a toggle switch for 'Enable' (currently orange), a text input for 'Name' with the value 'session1', a toggle switch for 'Active' (currently red), and a dropdown menu for 'Trigger' with the value 'manual'.

Mode	Description
manual	Use this setting to manually enable the input. When set to manual, click the <b>Activate</b> button to perform the input switching.
input connected	Use this setting to allow the encoder group to use automatic input detection. Once a new source is connected, that source becomes the active source.

### Activate

Click this button to activate the encoder group.

### Members

This field lists all members (encoder IP addresses) that have been added to the group. Use the **Add** button to add members to the group.

### Add

Click this button to add the IP address of an encoder to the group. Note that when adding encoders to the group, the IP address of the encoder, which is being used to create the group, must be included.

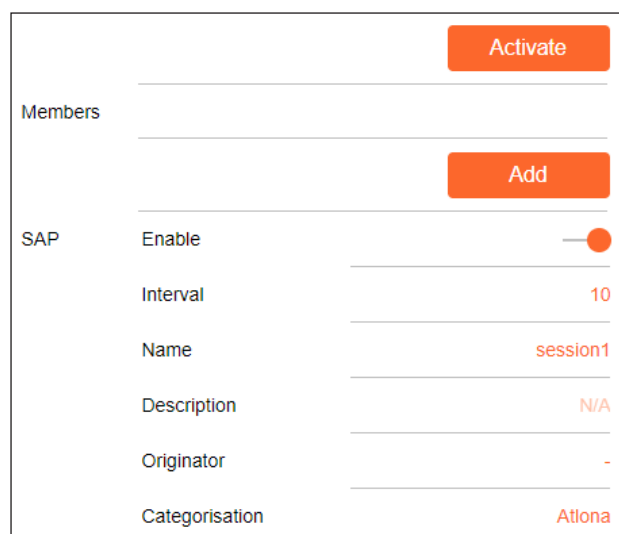

A screenshot of the EncGroup configuration form showing the 'SAP' section. It includes an 'Activate' button, a 'Members' list, an 'Add' button, and fields for 'SAP Enable' (toggle), 'Interval' (10), 'Name' (session1), 'Description' (N/A), 'Originator' (-), and 'Categorisation' (Atlona).

## SAP

### SAP

Click this switch to enable or disable the Session Announcement Protocol. When enabled, the toggle switch will be orange.

### Interval

Sets the announcement interval.

### Name

The name of the SAP session. By default, this is the same as the session name.

### Description

The SAP description.

### Originator

The ID of the SAP message originator.

### Categorisation

The SAP category. This field can be changed, if desired.



## Scrambling

### Enable

Click this toggle switch to enable or disable scrambling on the encoder. Atlona recommends enabling scrambling for security purposes. Session Announcement Protocol. When enabled, the toggle switch will be orange.

Scrambling	Enable	<input checked="" type="checkbox"/>
	Key	N/A

### Key

This field is only displayed if the **Scrambling** toggle switch is enabled (green). Enter the scrambling key in this field. The scrambling key must be ASCII and must contain a minimum of eight characters. Special characters and spaces are not permitted.

## Video

### Encoder

Click this drop-down list to select the encoder input.

### Enable

Click this toggle switch to enable or disable the video signal. When enabled (orange), video will pass from the encoder to the decoder.

### Destination IP address

Enter the IP address of the decoder that will be receiving the video stream.

### Destination UDP port

Enter the destination UDP port in this field.

### TTL

Set the TTL (Time-To-Live) duration, from 1 to 255 seconds, in this field. The default value is 255 seconds.

### DSCP

*Differentiated Services Code Point* (DSCP) is a method of managing network traffic, in addition to providing *Quality of Service* (QoS) within the Layer-3 (Network Layer) of the OSI network model. DSCP uses the 6-bit Differentiated Services (DS) field in the IP header in order to determine packet classification/priority. Normally, all routers and switches will forward network traffic to the proper destination with the same priority, no matter what type of data it is. This methodology is what is known as *Best Effort*.

The **Best Effort** setting will provide normal priority for data packets, while other settings will raise the priority on data packets. However, it should be noted that a higher priority setting on one type of data type may also result in data packet loss for other data types, depending upon network traffic.

When QoS or differentiated services policy is used, all network devices such as routers, networks switches, and end-devices must be configured properly in accordance with QoS policies on the network. There are two main methodologies for tagging traffic: Assured Forwarding and Class Selectors.

The tables on the next page provide a list of the available selections and their description.



**IMPORTANT:** Consult the IT administrator as to what methods to use and the required settings for each encoder on the network.

Video	Encoder	vc2_encoder1
	Enable	<input checked="" type="checkbox"/>
	Destination IP address	225.0.0.7
	Destination UDP port	1000
	TTL	255
	DSCP	Best effort
	FEC enable	<input checked="" type="checkbox"/>
	FEC rows	15
	FEC columns	15

Table 1.1 - Assured Forwarding

Selection	Queue Classification	Drop Probability
AF11	Class 1	Low
AF21	Class 2	Low
AF31	Class 3	Low
AF41	Class 4	Low

Table 1.2 - Class Selectors

Selection	Class Selector Name
CS0 / Best Effort	Routine
CS1	Priority
CS2	Immediate
CS3	Flash
CS4	Flash Override
CS5	Critical
CS6	Interwork Control
CS7	Network Control
EF	Expedited Forwarding

#### FEC enable

Click this toggle switch to enable (green) or disable Forward Error Correction (FEC). This feature can be used when transporting streams over a network that is suspected to be unreliable, due to noise or other factors. By default, this feature is enabled. Refer to [FEC Details \(page 134\)](#) for more information.

#### FEC rows

Specify the number of FEC rows in this field. Refer to [FEC Details \(page 134\)](#) for more information.

#### FEC Columns

Specify the number of FEC columns in this field. Refer to [FEC Details \(page 134\)](#) for more information.

#### Source

Click this drop-down list to select the desired input. Available values are: **Not used**, **audio\_generator1**, **hdmi\_input1**, and **hdmi\_input2**.

#### Enable AES67

Click this toggle switch to enable AES67. When this feature is enabled, the toggle switch will be green.

#### Downmixing

This field will only be available when AES67 is enabled. Available values are: **none**, **mono**, and **stereo**.

#### Enable Audio

Click this toggle switch to enable or disable the audio signal. When enabled (orange), audio will pass from the encoder to the decoder.

#### Destination IP address

Enter the IP address of the decoder that will be receiving the audio stream.

#### Destination UDP port

Enter the destination UDP port in this field.

#### TTL

Set the TTL (Time-To-Live) duration, from 1 to 255 seconds, in this field. The default value is 255 seconds.

### DSCP

Refer to the information on page 113 on DSCP settings.

### FEC enable

Click this toggle switch to enable (green) or disable Forward Error Correction (FEC). This feature can be used when transporting streams over a network that is suspected to be unreliable, due to noise or other factors. By default, this feature is enabled. Refer to [FEC Details \(page 134\)](#) for more information.

### FEC rows

Specify the number of FEC rows in this field. Refer to [FEC Details \(page 134\)](#) for more information.

### FEC Columns

Specify the number of FEC columns in this field. Refer to [FEC Details \(page 134\)](#) for more information.

## Audio

### Source

Click this drop-down list to select the method of how commands are transmitted.

### Enable

Click this toggle switch to enable or disable the AUX signals. When enabled (orange), control signals will pass from the encoder to the decoder.

### Destination IP address

Enter the IP address of the decoder that will be receiving the control signals.

### Destination UDP port

Enter the destination UDP port in this field.

### TTL

Set the TTL (Time-To-Live) duration, from 1 to 255 seconds, in this field. The default value is 255 seconds.

### DSCP

Refer to the information on page 111 on DSCP settings.

### Bidirectional

Click this toggle switch to enable or disable bidirectional control. When enabled (orange), control signals will be able to pass from encoder to decoder, or from decoder to encoder.

### Listen port

Enter the listening port in this field.

### SAVE

Click this button to commit all changes within the **Session** window group.

Audio	Source	hdmi_input1 ▾
	Enable AES67	<input checked="" type="checkbox"/>
	Downmixing	none ▾
	Enable	<input checked="" type="checkbox"/>
	Destination IP address	225.0.0.8
	Destination UDP port	1100
	TTL	255
	DSCP	Best effort ▾
	FEC enable	<input checked="" type="checkbox"/>
	FEC rows	4
	FEC columns	4

**AUX**

**Source**

Click this drop-down list to select the method of how commands are transmitted.

Source	Description
Not Used	Serial control is disabled
Commands	Commands are sent using CEC (over HDMI)
Serial Port 1	Commands are transmitted using Serial Port 1
Serial Port 2	Commands are transmitted using Serial Port 2

**Enable**

Click this toggle switch to enable or disable the AUX signals. When enabled (orange), control signals will pass from the encoder to the decoder.

**Destination IP address**

Enter the IP address of the decoder that will be receiving the control signals.

**Destination UDP port**

Enter the destination UDP port in this field.

**TTL**

Set the TTL (Time-To-Live) duration, from 1 to 255 seconds, in this field. The default value is 255 seconds.

**DSCP**

Refer to page 111 for information on DSCP settings.

**Bidirectional**

Click this toggle switch to enable or disable bidirectional control. When enabled (orange), control signals will be able to pass from encoder to decoder, or from decoder to encoder.

**Listen port**

Enter the listening port in this field.

**SAVE**

Click this button to commit all changes within the **Session** window group.

AUX

Source Commands ▾

---

Enable

---

Destination IP address N/A

---

Destination UDP port 1200

---

TTL 255

---

DSCP Best effort ▾

---

Bidirectional

---

Listen port 1204

---

**SAVE**

## Logo page

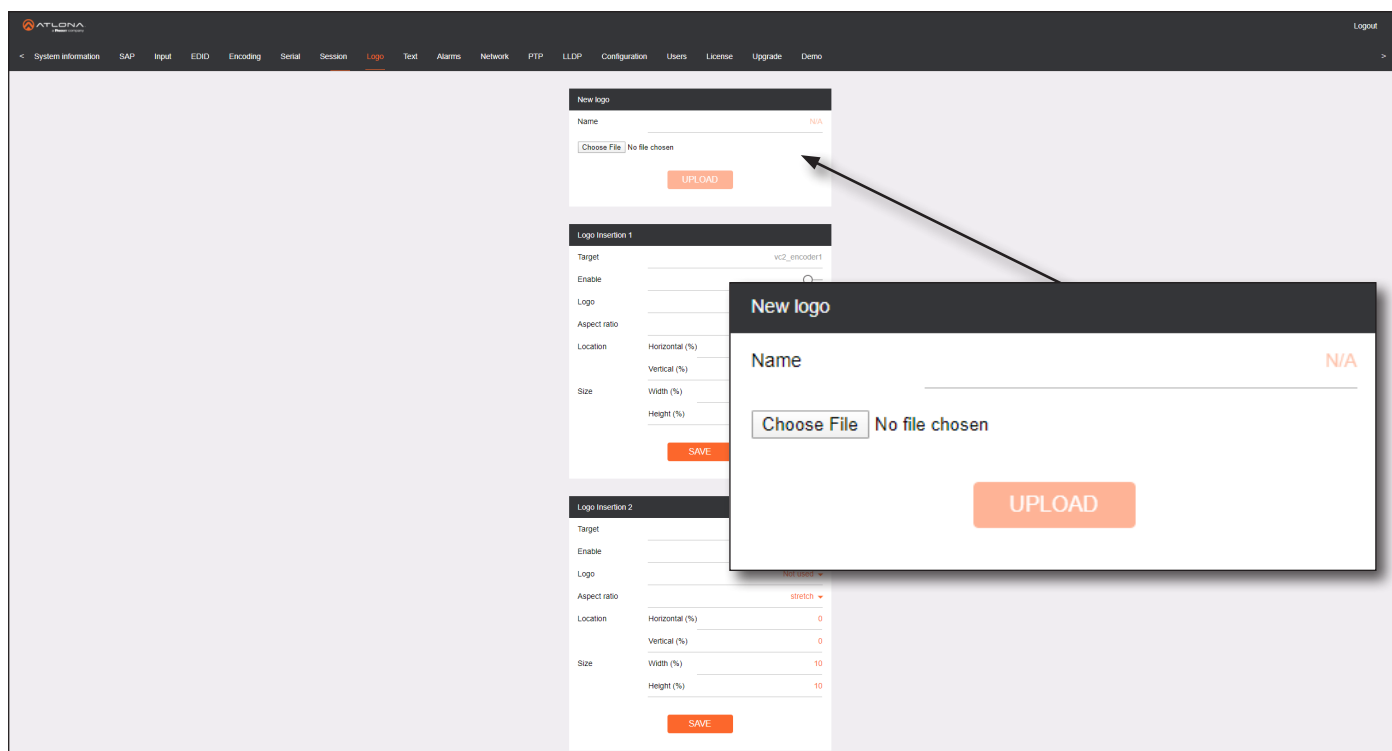

### New logo window group

#### Name

Enter a name for the logo in this field.

#### Choose File

Click this button to select the logo file to be uploaded. Files must be in .png format and must not exceed 5 MB (5120000 bytes) in size. When an image file is uploaded, it will appear in the **Logo** drop-down list.

#### UPLOAD

Click this button to upload the logo file to the encoder.

### Logo Insertion window groups

The following fields apply to both **Logo Insertion** window groups. The single-channel encoder will only have one **Logo Insertion** window group.

#### Target

Displays the name of the encoder. This field cannot be changed.

#### Enabled

Click the toggle switch to enable or disable the logo. If the toggle switch is orange, then the logo will be enabled.

#### Logo

Click this drop-down list to select the desired logo. To disable the use of a logo, set to **Not Used**.

#### Aspect Ratio

Click this drop-down list to select the type of aspect ratio to be applied to the logo.

Logo Insertion 1	
Target	vc2_encoder1
Enable	<input type="checkbox"/>
Logo	Not used ▾

**Horizontal (%)**

Enter the horizontal position of the logo on the screen. This value is based on the total horizontal resolution of the screen.

**Vertical (%)**

Enter the vertical position of the logo on the screen. This value is based on the total vertical resolution of the screen.

**Width (%)**

Enter the width of the logo. This value is based on the total horizontal resolution of the screen.

**Height (%)**

Enter the height of the logo. This value is based on the total vertical resolution of the screen.

**SAVE**

Click this button to commit all changes within the **Logo Insertion** window group.

Aspect ratio	<input type="text" value="stretch"/>	
Location	Horizontal (%)	<input type="text" value="0"/>
	Vertical (%)	<input type="text" value="0"/>
Size	Width (%)	<input type="text" value="10"/>
	Height (%)	<input type="text" value="10"/>
<input type="button" value="SAVE"/>		

Text page

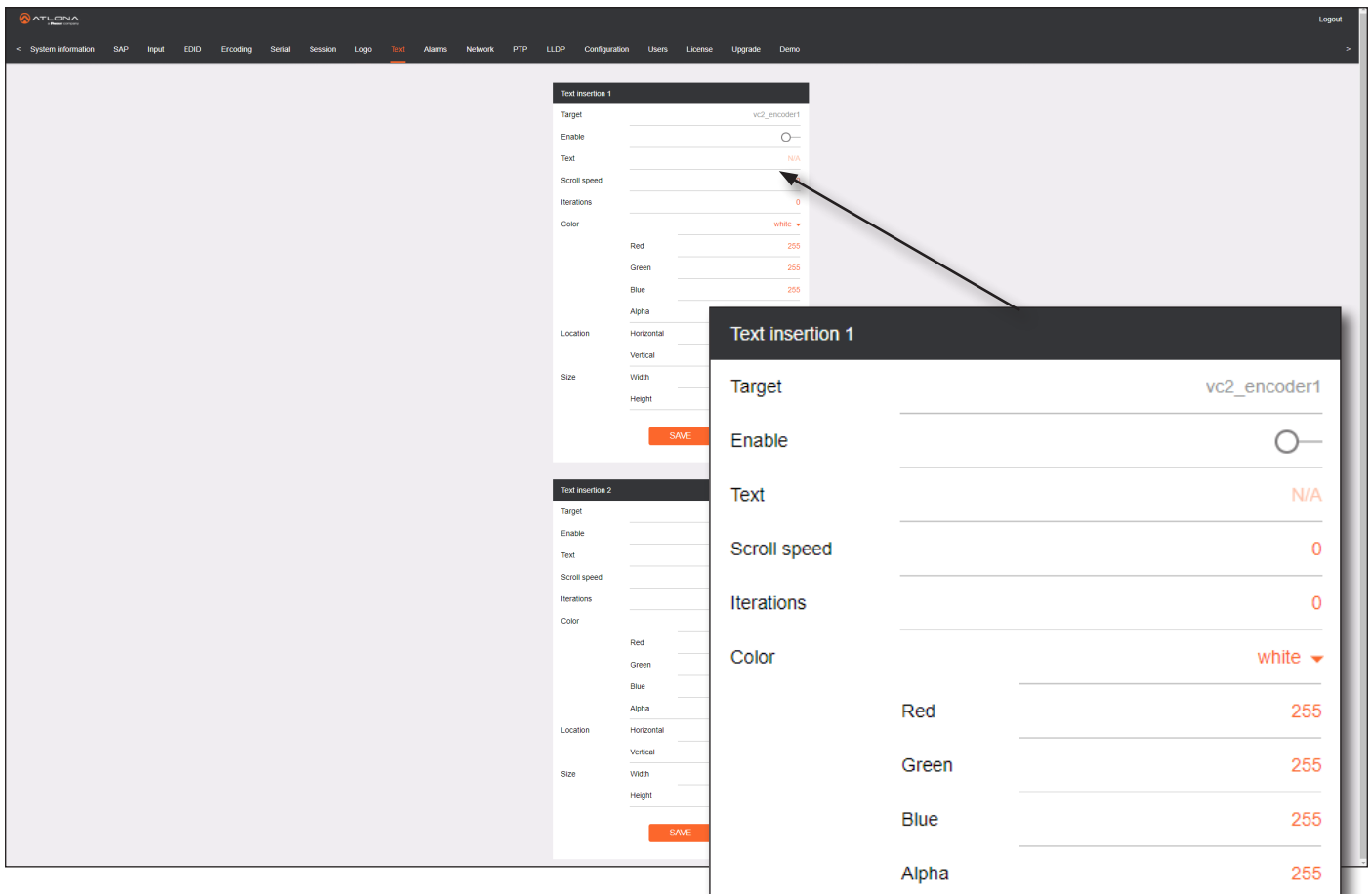

**Text insertion window groups**

The following fields apply to both **Text insertion** window groups. The single-channel encoder will only have one **Text insertion** window group.

**Enabled**

Click this toggle switch to enable or disable the text. When the toggle switch is orange, the text will be enabled.

**Text**

Enter the desired text in this field.

**Scroll Speed**

Enter the scrolling speed in this field. Values from -255 to 255 are valid. Negative numbers will scroll the text from left to right. Positive numbers will scroll text from right to left.

**Iterations**

Enter the number of iterations in the **Iteration** field. Set this field to 0 (zero) to set the number of iterations to infinity.

**Color**

Click this drop-down list to select a solid color preset: **red, green, black, white, yellow, or blue.**

**Red, Green, Blue, Alpha**

Click these fields to fine tune the color of the text. Adjust the **Alpha** field to control the transparency of the text. An alpha value of 255 is opaque and a value of 0 is transparent. Numbers from 0 to 255 are valid for all fields.

**Horizontal**

Enter the horizontal position of the text in this field.

**Vertical**

Enter the vertical position of the text in this field.

**Width**

Enter the width of the text in this field. This value is based on the horizontal resolution of the screen.

**Height**

Enter the height of the text in this field. This value is based on the vertical resolution of the screen.

Location	Horizontal	<input type="text" value="0"/>
	Vertical	<input type="text" value="0"/>
Size	Width	<input type="text" value="10"/>
	Height	<input type="text" value="10"/>

**SAVE**

Click this button to commit all changes within the **Text insertion** window group.



## Network page

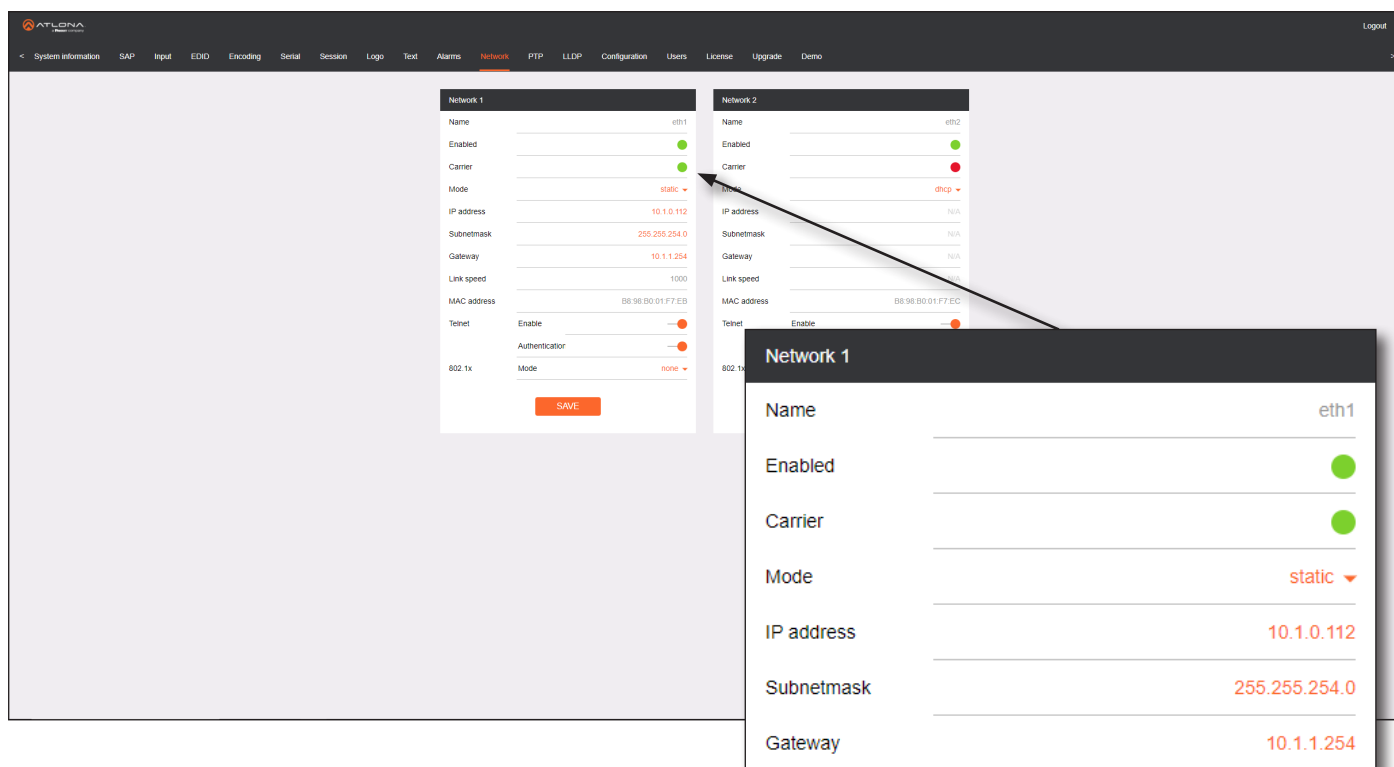

### Network window groups

The following fields apply to both **Network** window groups. The single-channel encoder will only have one **Network** window group.

#### Name

Displays the name of the Ethernet interface. This field cannot be changed.

#### Enabled

This indicator displays whether or not the video stream for this channel is active. If the indicator is green, then the video stream is active.

#### Carrier

If this indicator is green, then an active link exists. Otherwise, if no link exists, this indicator will be red.

#### Mode

Click this drop-down list to select the desired IP mode. Select DHCP to let the DHCP server (if present) assign the encoder the IP settings; **Subnet** and **Gateway** fields will automatically be populated. When **Static** mode is selected, the information for the **IP Address**, **Subnet**, and **Gateway** fields must be entered.

#### IP Address

Displays the IP address used by the channel. This field can only be changed if **Static** mode is selected.

#### Subnetmask

Displays the subnet mask for the channel. This field can only be changed if **Static** mode is selected.

#### Gateway

Displays the gateway (router) address for the channel. This field can only be changed if **Static** mode is selected.

**Link speed**

Displays the Ethernet interface link speed in Mbps. This field cannot be modified.

**MAC address**

Displays the MAC address of the Ethernet interface.

**Telnet Enable**

Click this toggle switch to enable or disable Telnet. If disabled, then Telnet sessions to the encoder cannot be established.

**Telnet Authenticator**

Click this toggle switch to enable or disable Telnet authentication. If enabled, then the toggle switch will be orange. Once enabled, connecting to the encoder using Telnet will require login credentials. The default credentials are:

Username: admin  
Password: Atlona

**802.1x Mode**

Click this drop-down list to select the desired authentication mode.

**SAVE**

Click this button to commit all changes within the **Network** window group.

Link speed	1000
MAC address	B8:98:B0:01:F7:EB
Telnet	Enable <input checked="" type="checkbox"/>
	Authentication <input checked="" type="checkbox"/>
802.1x	Mode <span>none ▼</span>
<input type="button" value="SAVE"/>	

## PTP page

The **PTP** page provides options for adjust Precision Time Protocol (PTP) for AES67 audio streams. PTP is used by AES67 to keep all audio streams synchronized.

For a system utilizing PTP, all devices undergo an automatic self-election process to choose the interface to be used as the PTP grandmaster (GM) clock, based on the accuracy of the device's clock and the device's configured priority. A lower priority number means the unit is more likely to get selected as GM.



**IMPORTANT:** If a new device is added to the network and the GM changes, a brief outage will be experienced while all connected devices synchronize with the new clock. Because of this, Atlona recommends that one unit gets manually defined as the GM and have both **Priority 1** and **Priority 2** fields be set to 1.

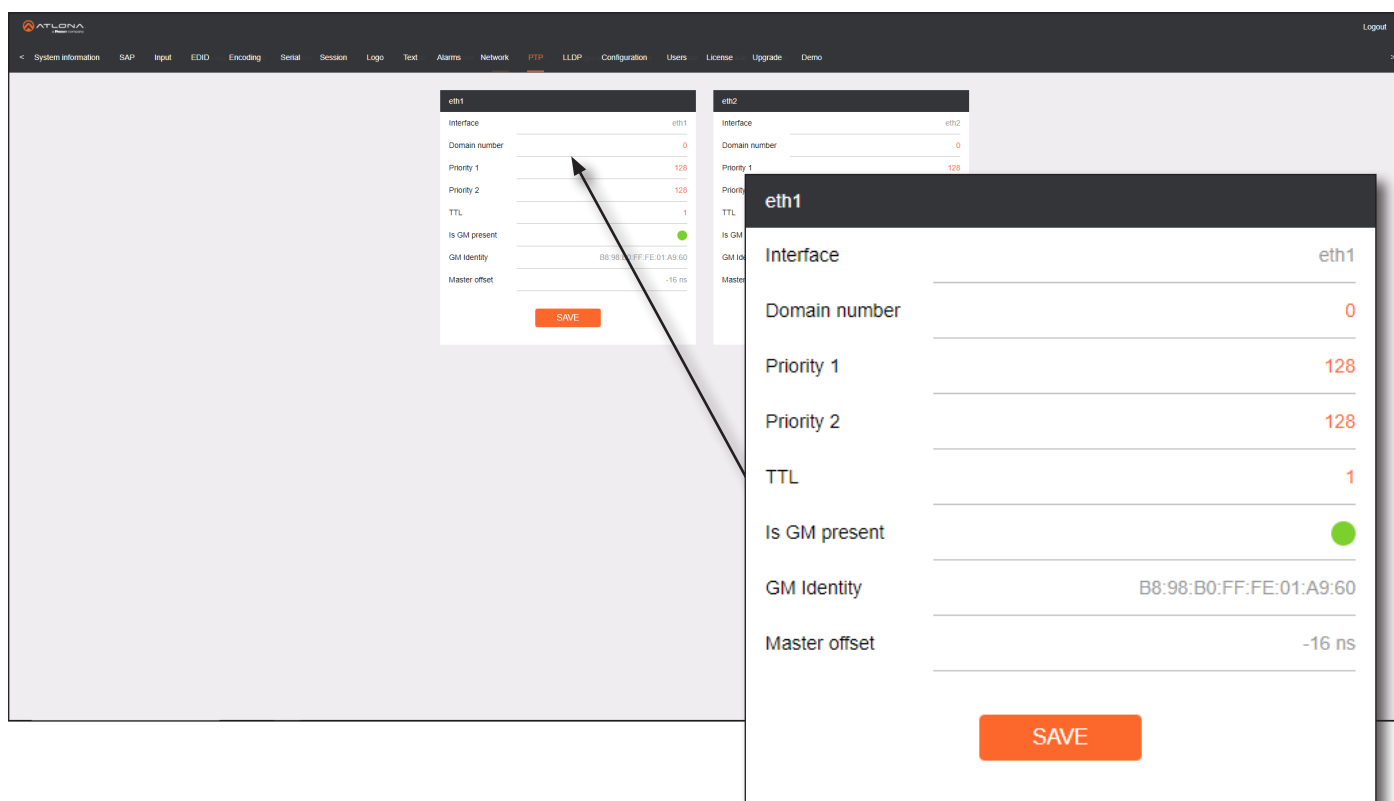

## eth window groups

The following fields apply to both **eth** window groups. The single-channel encoder will only have one **eth** window group.

### Interface

Displays the Ethernet interface associated with the PTP settings.

### Domain Number

Enter the domain number in this field. Valid entries are 0 through 127.

### Priority 1

Enter the priority number in this field.

### Priority 2

Enter the priority number in this field.

**TTL**

Displays the TTL value. PTP uses a default IPv4 TTL value of 1 for multicast. This value may be changed, if necessary, in order for the replies to reach the PTP monitor.

**Is GM Present**

This indicator displays the existence of a grandmaster clock for the specified PTP domain number. If the indicator is green, then the grandmaster clock exists on this interface.

**GM Identity**

The grandmaster clock identity. If this field is blank, then it means that this interface is the grandmaster clock.

**Master Offset**

Displays the grandmaster clock offset.

eth1	
Interface	eth1
Domain number	0
Priority 1	128
Priority 2	128
TTL	1
Is GM present	<span style="color: green;">●</span>
GM Identity	B8:98:B0:FF:FE:01:A9:60
Master offset	-16 ns

SAVE

## LLDP page

The Link Layer Discovery Protocol (LLDP) page returns information about the switch that the encoder is connected to. If both interfaces from a dual-channel encoder are connected to the switch, then two **eth** window groups will be displayed.



**NOTE:** LLDP must be enabled on the switch that the encoders are connected to, in order for the switch information to be displayed.

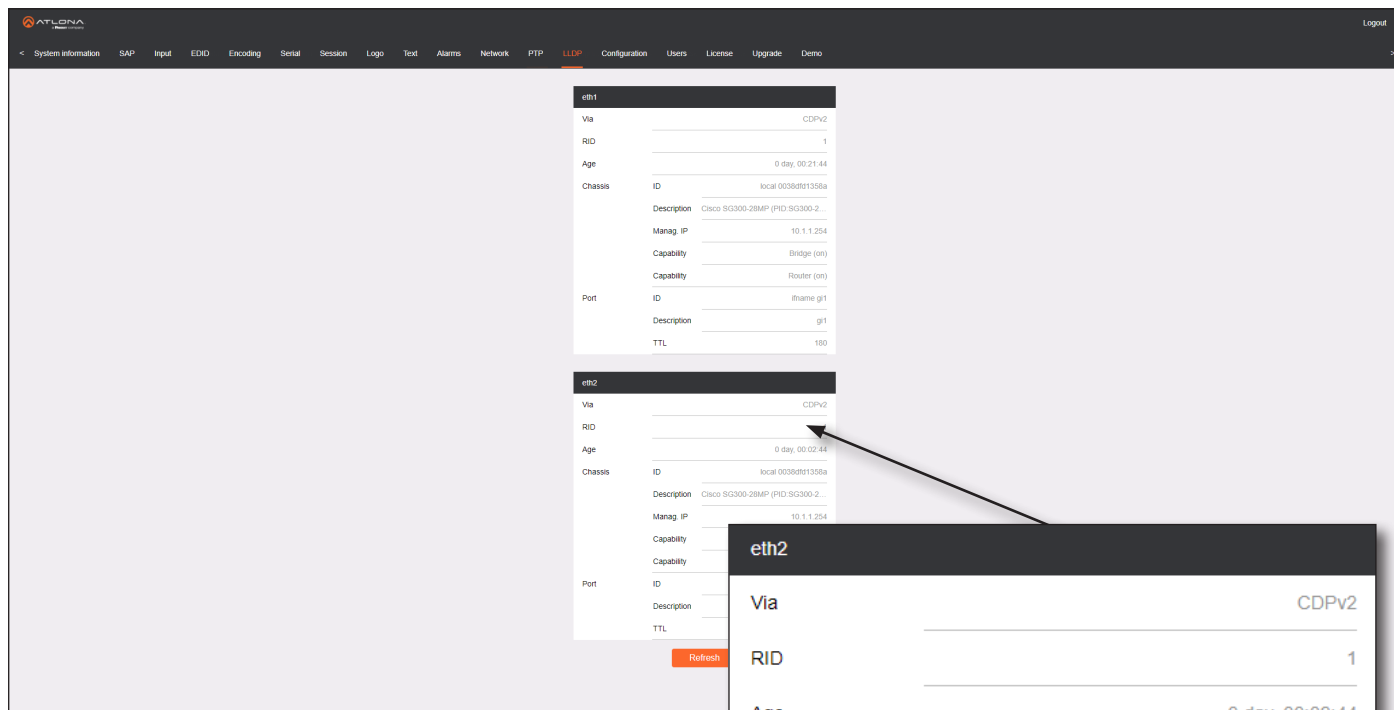

**Via**  
The discovery protocol being used.

**RID**  
The router ID.

**Age**  
Up-time of the interface.

**Chassis ID**  
The MAC address of the interface.

**Chassis Capability**  
Indicates the device function, such as bridge (switch), router, etc.

**Port ID**  
The port ID.

**Port Description**  
The type of port, such as gigabit Ethernet, fast Ethernet, etc.

**eth2**

<b>Via</b>	CDPV2										
<b>RID</b>	1										
<b>Age</b>	0 day, 00:02:44										
<b>Chassis</b>	<table border="0"> <tr> <td><b>ID</b></td> <td>local 0038dfd1358a</td> </tr> <tr> <td><b>Description</b></td> <td>Cisco SG300-28MP (PID:SG300-2...</td> </tr> <tr> <td><b>Manag. IP</b></td> <td>10.1.1.254</td> </tr> <tr> <td><b>Capability</b></td> <td>Bridge (on)</td> </tr> <tr> <td><b>Capability</b></td> <td>Router (on)</td> </tr> </table>	<b>ID</b>	local 0038dfd1358a	<b>Description</b>	Cisco SG300-28MP (PID:SG300-2...	<b>Manag. IP</b>	10.1.1.254	<b>Capability</b>	Bridge (on)	<b>Capability</b>	Router (on)
<b>ID</b>	local 0038dfd1358a										
<b>Description</b>	Cisco SG300-28MP (PID:SG300-2...										
<b>Manag. IP</b>	10.1.1.254										
<b>Capability</b>	Bridge (on)										
<b>Capability</b>	Router (on)										
<b>Port</b>	<table border="0"> <tr> <td><b>ID</b></td> <td>ifname gi3</td> </tr> <tr> <td><b>Description</b></td> <td>gi3</td> </tr> <tr> <td><b>TTL</b></td> <td>180</td> </tr> </table>	<b>ID</b>	ifname gi3	<b>Description</b>	gi3	<b>TTL</b>	180				
<b>ID</b>	ifname gi3										
<b>Description</b>	gi3										
<b>TTL</b>	180										

[Refresh](#)

**TTL**  
The Time-To-Live value.

**Refresh**  
Click this button to refresh the page after a port change.

## Configuration page

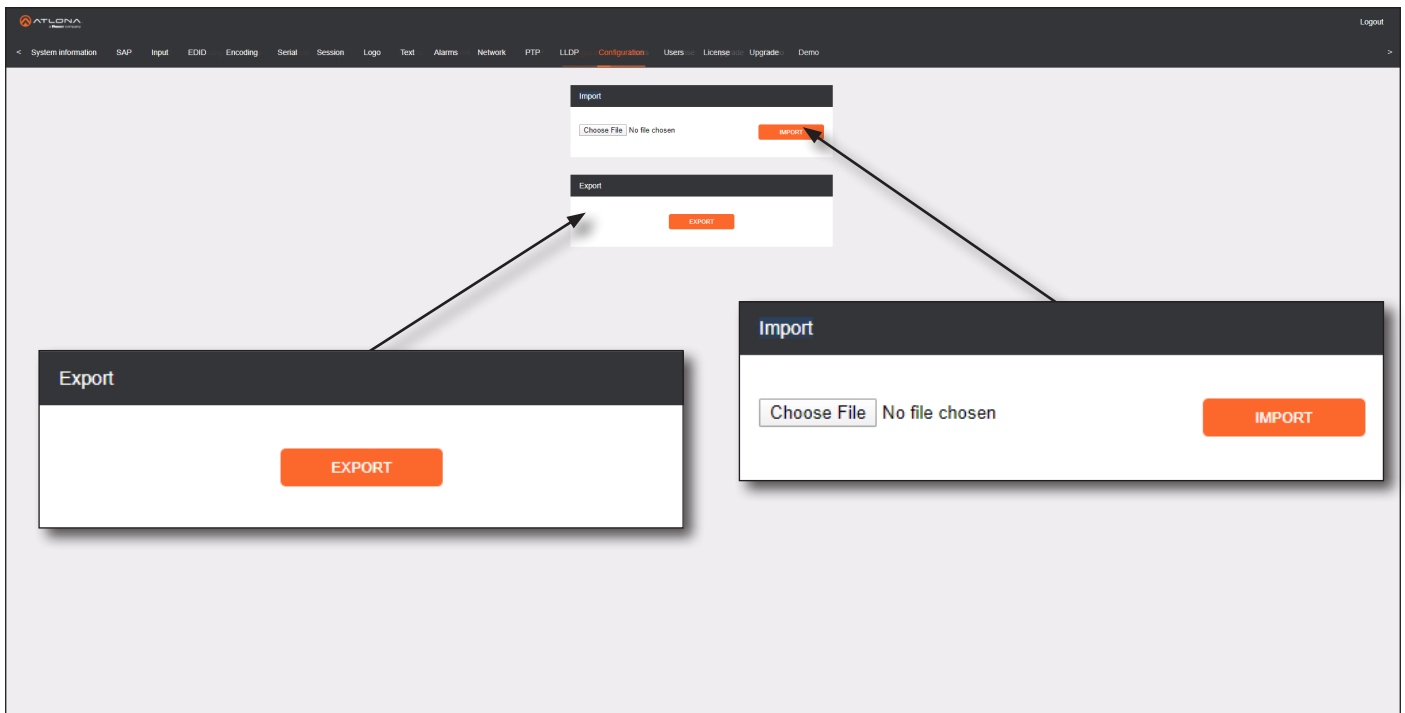

### Choose File

Click this button to select the desired configuration file to be uploaded.

### IMPORT

Click this button to upload the selected configuration file to the encoder.

### EXPORT

Click this button to export the current encoder system configuration to a .json file.

## Users page

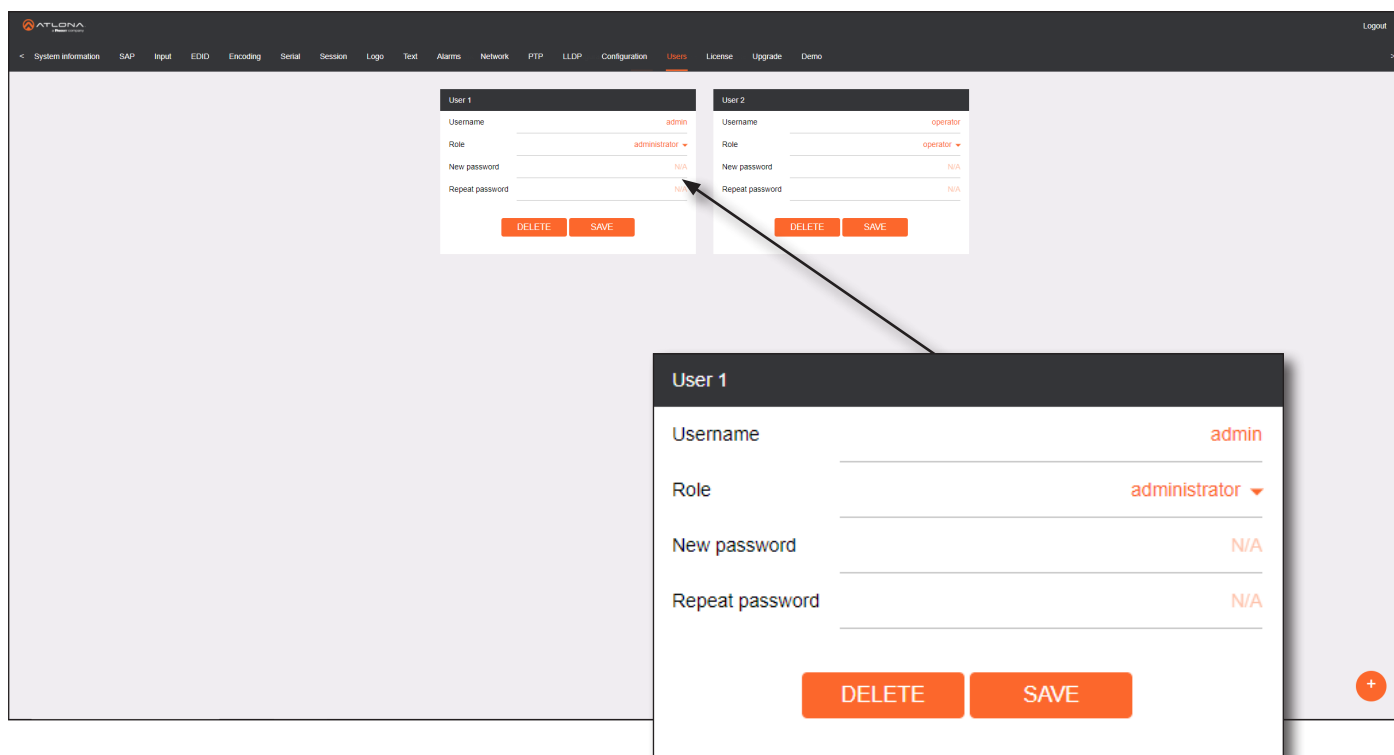

### User window groups

The following fields apply to all **User** window groups. Encoders have two usernames, by default: **admin** and **operator**.

#### Username

Enter the desired username in this field.

#### Role

Click this drop-down list to select the desired role of the user.

#### New password

Enter the desired password for the username in this field.

#### Repeat password

Confirm the new password by entering it in this field.

#### DELETE

Click this button to delete the user in the current window group. Note that there must be at least one admin role at all times. Therefore, if one **admin** role and one **operator** role exist, then the **admin** user cannot be deleted.

#### SAVE

Click this button to commit all changes within the current user window group.



#### New user

Click this button to create a new user. Provide the role and password, as described in the fields above.

## License page

This page displays all installed licenses and allows additional licenses to be installed.

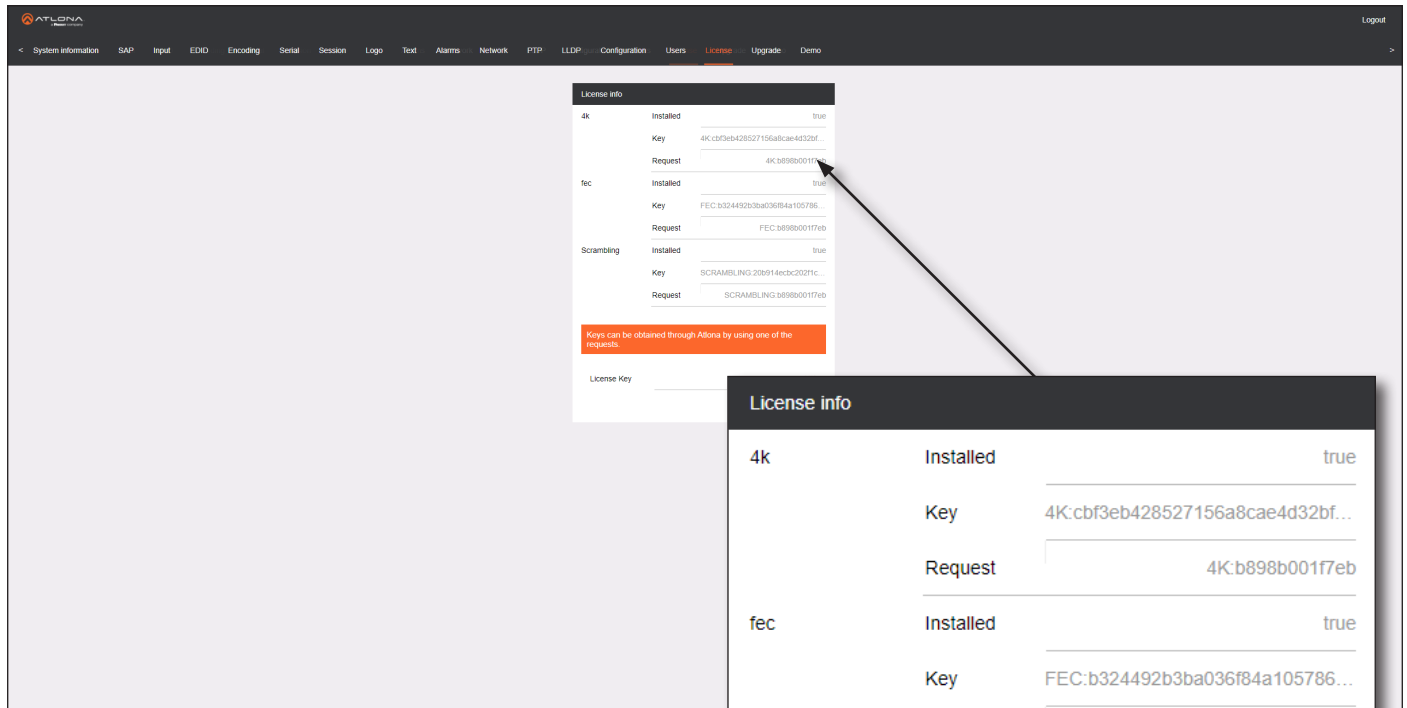

The screenshot shows the ATLONA web interface with the 'License' page selected in the navigation menu. The main content area displays a table of installed licenses:

License ID	Status	Key	Request
4k	Installed	4K:cbf3eb428527156a8cae4d32bf...	4K:b898b001f7eb
fec	Installed	FEC:b324492b3ba036f84a105786...	FEC:b898b001f7eb
Scrambling	Installed	SCRAMBLING:20b914ecbc202f1c...	SCRAMBLING:b898b001f7eb

An orange banner below the table states: "Keys can be obtained through Atlona by using one of the requests." Below this is a "License Key" input field.

The modal window titled "License info" provides a detailed view of the selected license (4k):

4k	Installed	true
Key	4K:cbf3eb428527156a8cae4d32bf...	
Request	4K:b898b001f7eb	
fec	Installed	true
Key	FEC:b324492b3ba036f84a105786...	
Request	FEC:b898b001f7eb	
Scrambling	Installed	true
Key	SCRAMBLING:20b914ecbc202f1c...	
Request	SCRAMBLING:b898b001f7eb	

Below the modal, there is an orange banner with the same text: "Keys can be obtained through Atlona by using one of the requests." At the bottom, there is a "License Key" input field with "N/A" as a placeholder and an "INSTALL LICENSE" button.

### License Key

Enter the license key in this field.

### INSTALL LICENSE

Click this button to validate and install the license.



## Upgrade page

This page is used to update the firmware on the encoder.

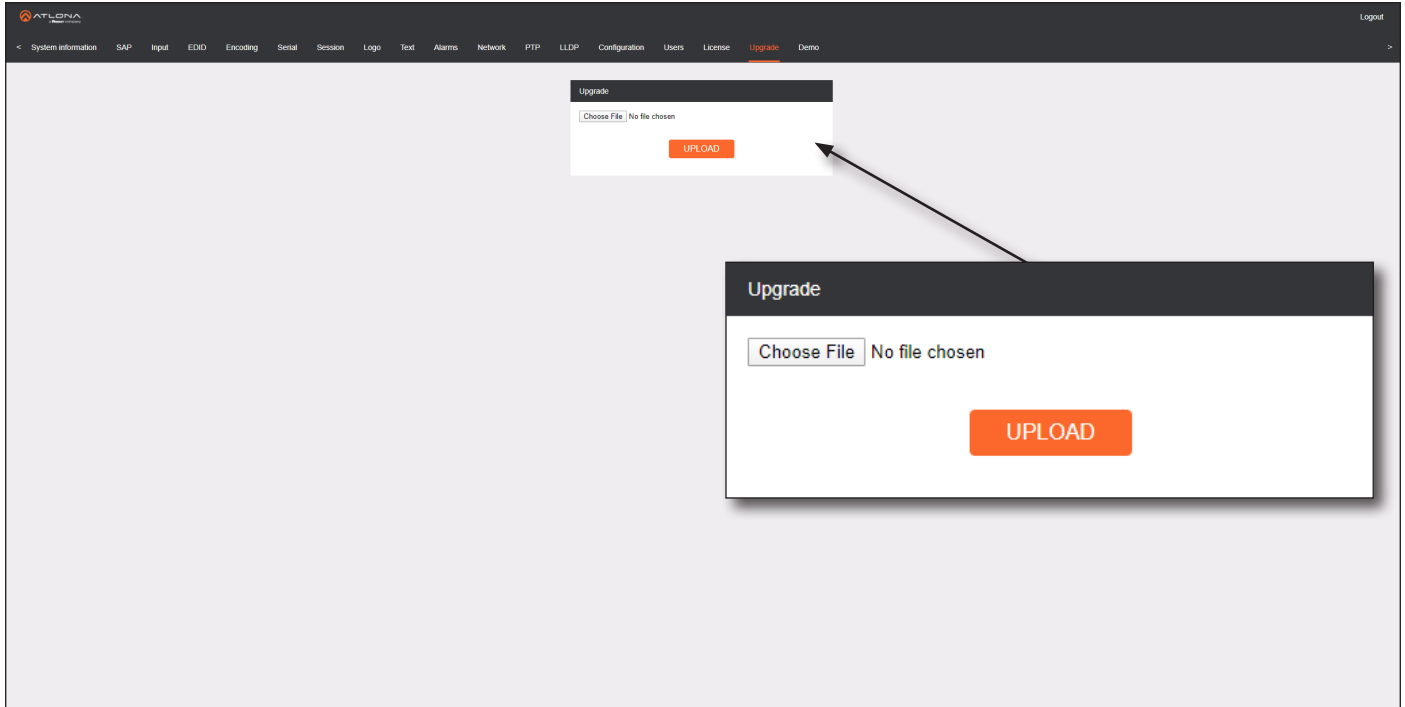

### Choose File

Click this button to select the firmware file to be uploaded.

### UPLOAD

Click this button to upload the selected firmware file.

## Appendix

### Updating the Firmware using Velocity™/AMS

#### IMPORTANT:



- If updating from version 1.0.x, OmniStream units must first be updated to version 1.1. Note that this does *not* apply to OmniStream R-Type units. If running version 1.0.x, contact an Atlona Technical Support Engineer before updating the firmware.
- When updating the firmware, make sure that the unit does not lose power. The firmware update process should take approximately 1 to 2 minutes.
- For full functionality of OMNI 1.2.1 (or later), Velocity must be running at least 1.4.5 and AMS must be on firmware version 2.0.12 and above.

1. Click **DEVICE INFO** in the menu bar.
2. Click the **UPDATE FIRMWARE** button to display the **Firmware Update** dialog.

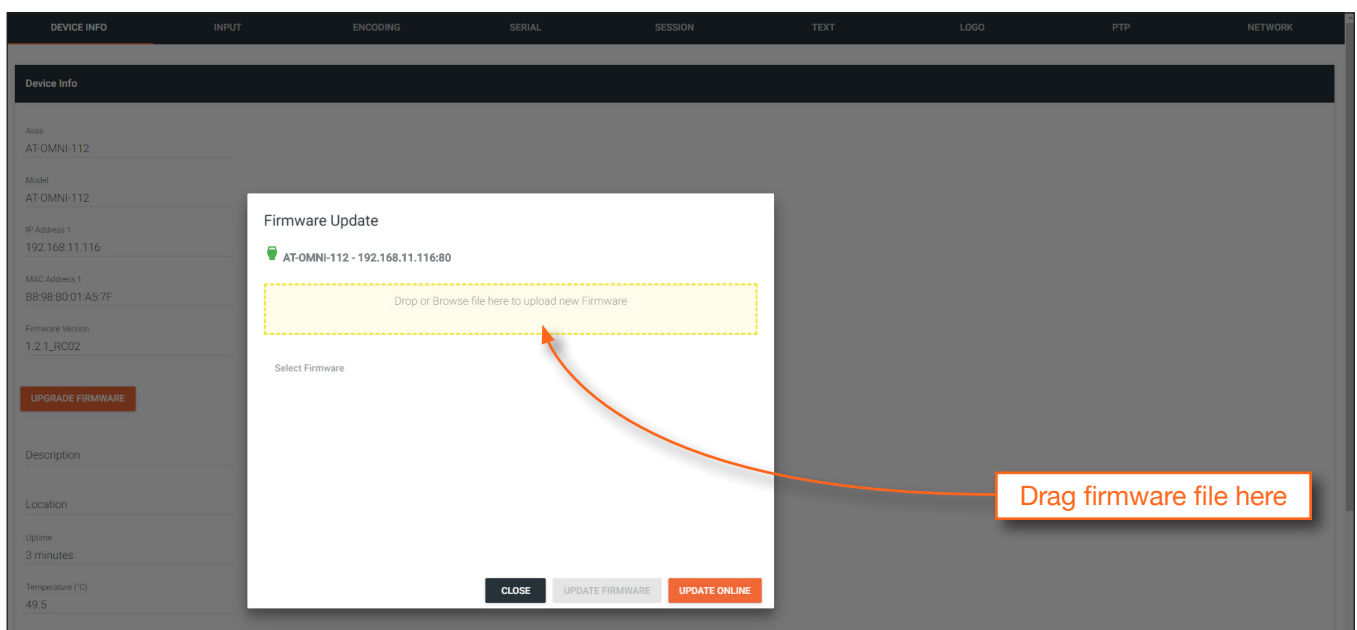

- Click and drag the firmware file to the yellow box, to upload the firmware to the device. OmniStream firmware files use the .vpup file extension. Once the firmware file has been uploaded, it will appear under the **Select Firmware** section of the dialog box.
- Click the **UPDATE FIRMWARE** button to begin the update process.

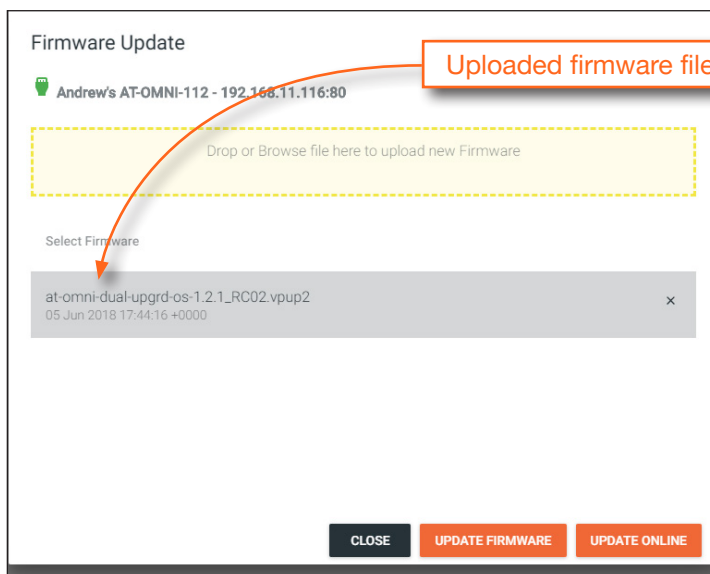

Firmware file	OmniStream SKU
at-omni-single-upgrd-os-[version].vpup2	AT-OMNI-111, AT-OMNI-121, AT-OMNI-111-WP
at-omni-dual-upgrd-os-[version].vpup2	AT-OMNI-112, AT-OMNI-122
at-omni-residential-upgrd-os-[version].vpup2	AT-OMNI-512, AT-OMNI-521

- After the **UPDATE FIRMWARE** button is clicked, the Upgrade Firmware Started message box will be displayed.

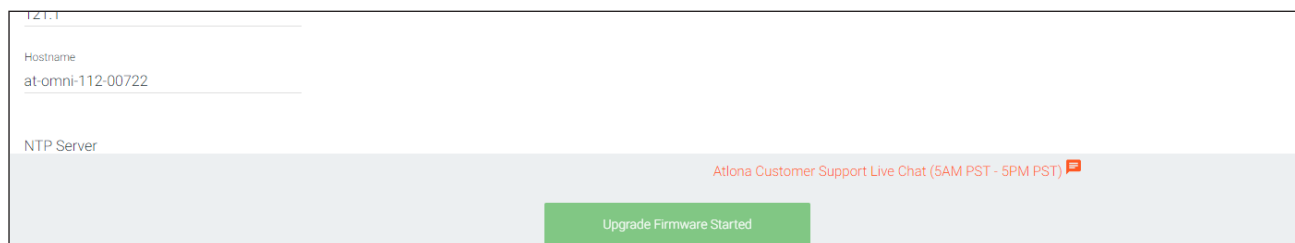

- Click the orange up-arrow icon, in the upper-right corner of the screen, as shown below. If this icon is orange, it indicates that a firmware update is in progress.

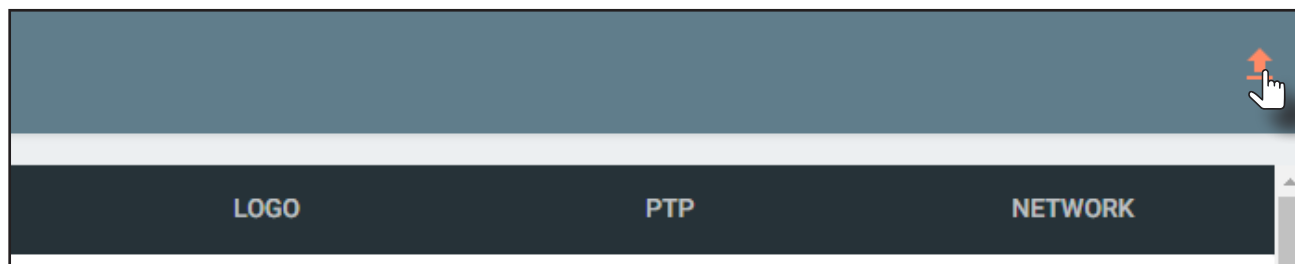

The progress bar for the update process will be displayed. The update process should take a few seconds.

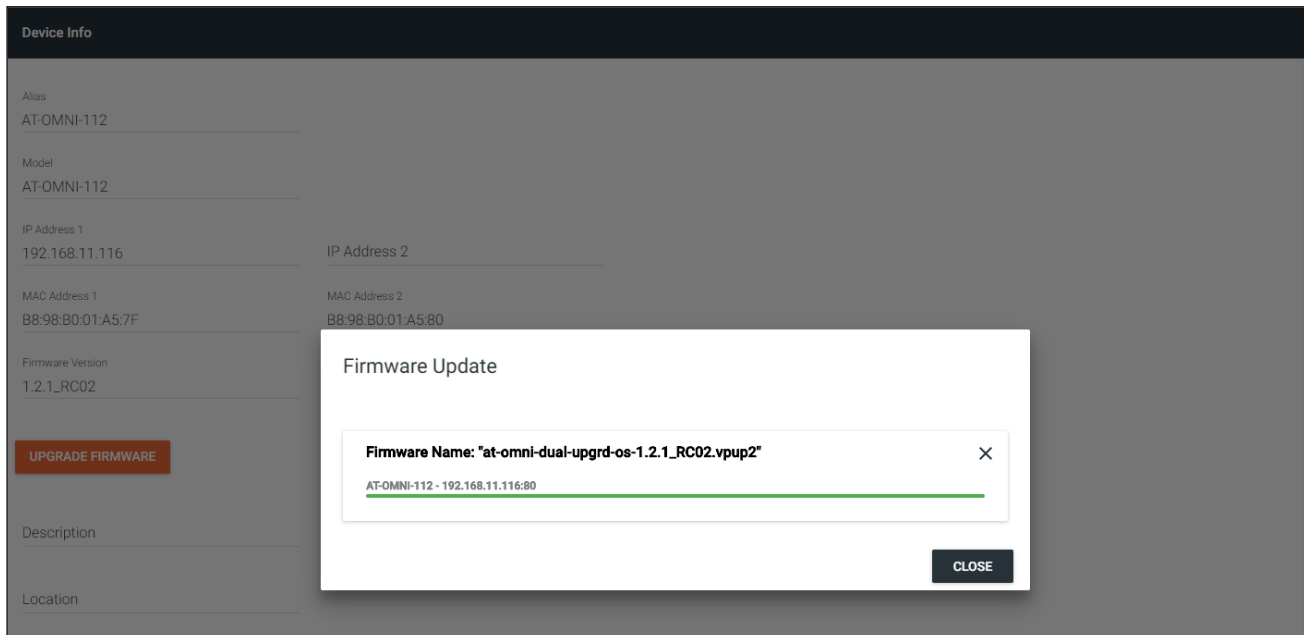

7. Click the "X" to close out the progress bar window, then click the **CLOSE** button to dismiss the **Firmware Update** message box.
8. The firmware update process is complete.
9. Clear the web browser cache and refresh the web page. The new firmware version will appear in the **Firmware Version** field, in the **DEVICE INFO** page.

## Updating the Firmware using the Web Server

Follow the procedure below to update OmniStream units using the built-in web server.

1. Launch the desired web browser and enter the IP address of the encoder/decoder in the address bar.
2. Enter the username and password. Note that the password field will always be masked. The default credentials are:

Username:           admin  
 Password:          Atlona

3. The **System Information** page will be displayed.
4. Click **Upgrade** in the menu bar to display the **Upgrade** page.
5. Click the **Choose File** button.

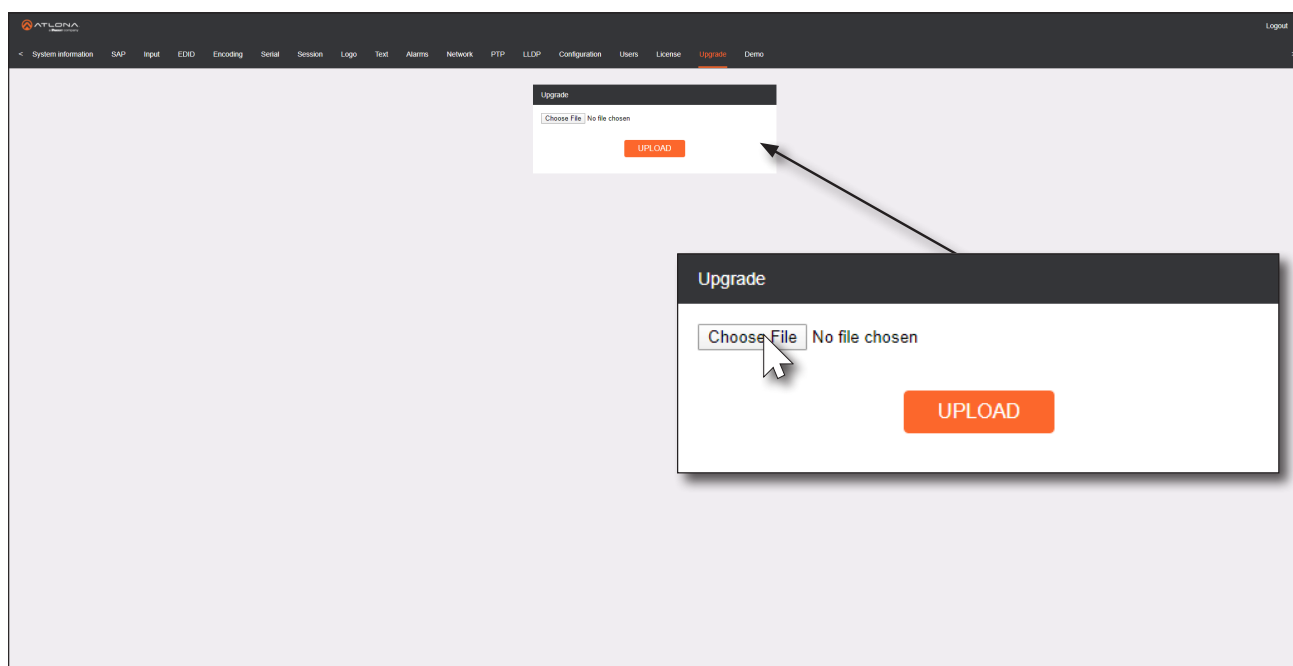

6. In the **Open** dialog box, select the correct firmware file. Refer to the table below.

Firmware file	OmniStream SKU
at-omni-single-upgrd-os-[version].vpup2	AT-OMNI-111, AT-OMNI-121, AT-OMNI-111-WP
at-omni-dual-upgrd-os-[version].vpup2	AT-OMNI-112, AT-OMNI-122
at-omni-residential-upgrd-os-[version].vpup2	AT-OMNI-512, AT-OMNI-521

7. Click the **UPLOAD** button.
8. A progress bar will be displayed, indicating the current upgrade status of the unit. When firmware update process has completed, the **Upgrade** page will be displayed.
9. The upgrade process is complete.

## FEC Details

### Matrix Size, Overhead, and Latency

- FEC can only work if a single packet from each row/column is missing. Multiple packets missing from each row/column will cause FEC to fail.
- Due to the above, a smaller matrix is more robust, as there is a better chance of errors not occurring in the same row/column.
- FEC has a bitrate overhead that is inversely proportional to the matrix size: the bigger the matrix, the less bitrate overhead is generated.
- FEC has a latency overhead that is directly proportional to the matrix size: the bigger the matrix, the more latency is introduced.
  - » As of v1.0.0, OmniStream does not explicitly synchronize audio and video. Therefore, FEC configuration can have a noticeable impact on lip sync. The tables below should be used to keep the audio/video lip sync as tight as possible.
- FEC latency overhead is also inversely proportional to bitrate: the higher the bitrate, the less FEC latency is introduced.
  - » For applications where lip sync is very critical, using a higher audio sampling rate, and thus a higher audio bitrate, can result in more accurate lip sync.

### FEC and Video Bitrate

- The bitrate configured on the video encoder includes FEC overhead and will automatically adjust itself depending on the bitrate needed for FEC.
- FEC overhead can be calculated using the following formulas:

$$\text{Video rate} = \frac{\text{Configured bit rate}}{1 + \left( \frac{\text{Rows} + \text{Columns}}{\text{Rows} \times \text{Columns}} \right)} \qquad \text{FEC rate} = \text{Configured bit rate} - \text{Video rate}$$

- The following table provides a few examples of how this works.

FEC / matrix usage	Configured bit rate	Used for video	Used for FEC
FEC disabled	900 Mbps	900 Mbps	0 Mbps
FEC enabled, 4x4	900 Mbps	600 Mbps	300 Mbps
FEC enabled, 10x10	900 Mbps	750 Mbps	150 Mbps
FEC enabled, 20x20	900 Mbps	818 Mbps	82 Mbps
FEC enabled, 4x4	450 Mbps	300 Mbps	150 Mbps
FEC enabled, 10x10	450 Mbps	375 Mbps	75 Mbps
FEC enabled, 20x20	450 Mbps	409 Mbps	41 Mbps

### FEC, Latency, and Lip Sync

- In order for FEC to work, the matrix must be filled in order to calculate the FEC packets. This introduces some additional latency. Due to high bitrates, this is not noticeable for video, but can be very significant for audio. Therefore, Atlona recommends either leaving FEC disabled for audio or using a very small matrix.
- Latency calculations are complex. The tables below provide some common working benchmarks. In order to minimize lip sync issues, try to match the additional latencies for video and audio as closely as possible.
  - » Video - additional video latency for enabling FEC using various matrix sizes.

Configured bit rate	4x4	10x10	20x20
900 Mbps	0.64 ms	3.20 ms	11.74 ms
450 Mbps	1.28 ms	6.40 ms	23.47 ms

- » Audio - additional audio latency for enabling FEC using various matrix sizes.

Format	1x4	2x4	4x4	10x10
2 channel PCM, 44.1 kHz	34.01 ms	68.03 ms	136.10 ms	850.30 ms
2 channel PCM, 48 kHz	31.25 ms	62.50 ms	125.00 ms	781.30 ms
2 channel PCM, 96 kHz	15.63 ms	31.25 ms	62.50 ms	390.60 ms
2 channel PCM, 192 kHz	7.81 ms	15.63 ms	31.25 ms	195.30 ms

- It is recommended to keep lip sync within  $\pm 1$  frame of video to prevent any noticeable syncing issues.
- Examples of good choices to minimize lip sync issues are:
  - » Video configured for 450 Mbps, FEC 10x10; Audio is 2 channel PCM, 192 kHz, FEC 1x4: 6.40 ms – 7.81 ms = -1.41 ms
  - » Video configured for 900 Mbps, FEC 10x10; Audio is 2 channel PCM, 48 kHz, FEC disabled: 6.40 ms – 0 ms = 6.40 ms

## Mounting Instructions

OmniStream encoders includes two mounting brackets and four mounting screws, which can be used to attach the unit to any flat surface.

1. Using a small Phillips screwdriver, remove the two screws from the left side of the enclosure.

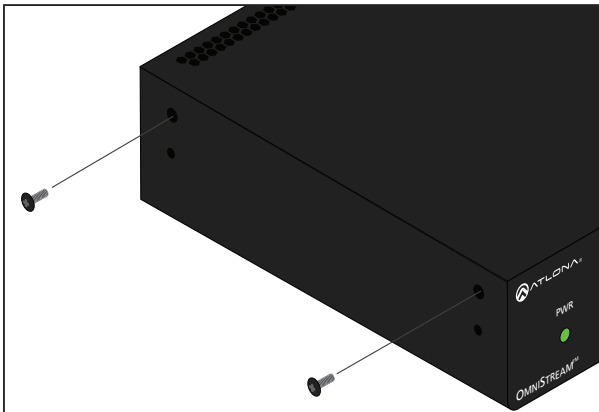

2. Position one of the rack ears, as shown below, aligning the holes on the side of the enclosure with one set of holes on the rack ear.
3. Use the enclosure screws to secure the rack ear to the enclosure.

Included screws

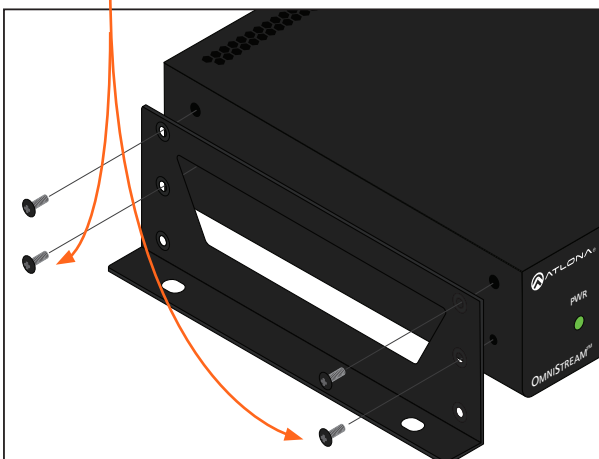

4. To provide added stability to the rack ear, use two of the included screws and attach them to the two holes, directly below the enclosure screws, as shown above.
5. Repeat steps 1 through 4 to attach the second rack ear to the opposite side of the unit.

6. Mount the unit using the oval-shaped holes, on each rack ear. If using a drywall surface, a #6 drywall screw is recommended.



**NOTE:** Rack ears can also be inverted to mount the unit under a table or other flat surface.



## Rack Tray for OmniStream

OmniStream encoders can also be mounted in the OmniStream rack tray (AT-OMNI-1XX-RACK-1RU). The rack tray is sold separately and provides easy mounting and organization of up to two OmniStream encoders/decoders in a convenient 1U rack tray. The OmniStream rack tray can be purchased directly from Atlona.

1. Position the OmniStream products, as shown in the illustration below.
2. Using the included screws, secure each unit to the rack with a Philips screwdriver.



**NOTE:** OmniStream units can be mounted forward-facing or back-facing, depending upon your requirements.

3. Install the entire assembly into an empty 1U slot in the rack.

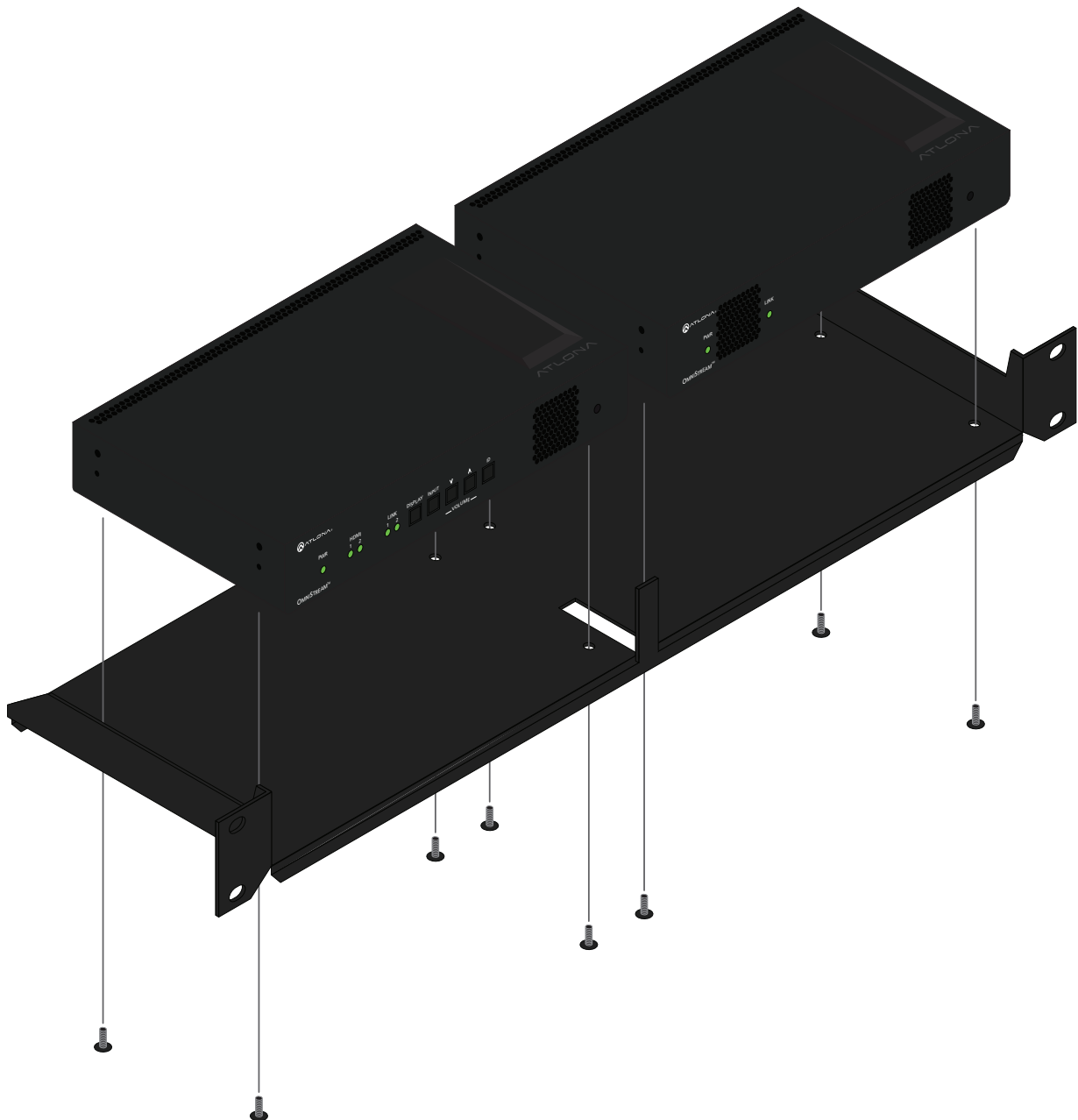



Protocols	
Video Streaming	RTP
Audio Streaming	RTP, up to 7.1 channels AES67, up to LPCM 7.1 channels
Addressing	DHCP, static
Encryption	AES-128
QoS Tagging	RFC 2475
Discovery	Multicast DNS, LLDP, SAP
Management	HTTPS, SSH, Telnet, and WebSockets with TLS
Authentication	IEEE 802.1x: PEAP/MSCHAPv2 or EAP-TLS
IP Multicast	IGMPv2 and IGMPv3 support

Graphics Features	
Text Insertion	Adjustable height/width, scrolling (speed, direction, or static), iterations (up to infinite), positioning, and adjustable color and alpha (transparency) channels.
Slate / Logo Insertion	PNG file format, adjustable aspect ratio (keep or stretch), horizontal/vertical size, screen position; slate mode can be set to off, manual (image always displayed, superimposed on the source signal, and will remain if source signal is lost), auto (image will only be displayed when source signal is lost).

Control	
RS-232	Device control and configuration; supports baud rates from 2400 to 115200 Bidirectional pass-through from control system to network
IR	Pass-through from control system to network Pass-through from network to control system

Connectors	
HDMI	1 - Type A, 19-pin, female, locking
ETHERNET <sup>(4)</sup>	1 - RJ45, 10/100/1000 Mbps
RS-232 / IR	1 - Euroblock, 6-pin (2 ports); RS-232 on port 1, IR on port 2
Power	1 - Euroblock, 2-pin

Indicators and Controls	
PWR	1 - LED, tricolor (red, amber, green)
HDMI	1 - LED, bicolor (red, green)
LINK	1 - LED, bicolor (red, green)
ID	1 - Momentary, tact type Provides two separate functions: (1) Sends an identification broadcast message over the network to any listening devices. (2) Reset the unit to factory-default settings.
Reboot	1 - momentary, tact-type

Power	
PoE	IEEE 802.3af
Consumption	Up to 12 W
External Power Supply (optional)	Input: 110 - 220 V AC, 50/60 Hz Output: 48 V DC, 0.83 A

Environmental	
Cooling System	Front-to-rear airflow, temperature-controlled fans
Operating Temperature	+14 to +122 °F -10 to +50 °C
Storage Temperature	-14 to +140 °F -10 to +60 °C
Operating Humidity (RH)	20% to 95%, non-condensing

Chassis	
Dimensions (H x W x D)	1.34 in x 8.19 in x 4.41 in 34 mm x 208 mm x 112 mm
Weight	1.5 lbs 0.7 kg

Certification	
Device	CE, FCC, CB, RoHS
Supply	CE, FCC, cULus, CB, RCM, RoHS

- (1) Only supported when Video Quality Optimization is set to Video mode.
- (2) Scaling and deinterlacing are not supported at 1080i.
- (3) All VESA resolutions are 60 Hz.
- (4) Maximum distance per hop is 330 feet (100 meters), depending upon network configuration.

## Dual-Channel Encoder

Video		
HDMI Specification <sup>(1)</sup>	HDMI 2.0b, HDCP 2.2	
UHD/HD/SD	4096x2160 (DCI) @ 60 <sup>(2)</sup> /30/24 Hz 3840x2160 (UHD) @ 60 <sup>(2)</sup> /50/24/25/30 Hz 1920x1080p @ 23.98/24/25/29.97/30/50/59.94/60 Hz 1920x1080i <sup>(3)</sup> @ 25/29.97/30 Hz 1280x720p @ 30/50/59.94/60 Hz	720x576p @ 50 Hz 720x576i @ 25 Hz 720x480p @ 59.94/60 Hz 720x480i @ 29.97/30 Hz
VESA <sup>(4)</sup>	2560x1600 1920x1200 1680x1050 1600x1200 1600x900 1440x900 1400x1050	1366x768 1360x768 1280x1024 1280x800 1280x768 1152x768 1024x768
Virtual Reality	2160x1200 @ 90 <sup>(2)</sup> Hz (HTC <sup>®</sup> Vive)	
Color Space	YUV, RGB	

Encoding			
Density	Dual encoding engines		
Compression Format	VC-2 (SMPTE-2042)		
Video Quality Optimization	User-selectable: PC Application or Video mode		
Chroma Subsampling	Chroma	PC Application	Video Mode
	4:4:4	Yes	No
	4:2:2	Yes	No
	4:2:0	No	Yes
Color Depth	8-bit, 10-bit, 12-bit		
HDR	HDR10, HLG, Dolby <sup>®</sup> Vision™		
Bit Rate	Configurable up to 900 Mbps		
Latency	0.5 frame (e.g. 1080p @ 60 Hz latency is < 8 ms between encoder and decoder) 1.5 frames in Fast Switching mode (e.g. 1080p @ 60 Hz latency is < 24 ms between encoder and decoder) Note: Unusual network configurations may increase overall latency		

Audio			
Pass-through	LPCM 2.0 LPCM 5.1 LPCM 7.1	Dolby <sup>®</sup> Digital Dolby Digital Plus Dolby TrueHD Dolby Atmos <sup>®</sup>	DTS <sup>®</sup> DTS-HD Master Audio™
Down-mixing	Multichannel LPCM to two-channel LPCM		
Sample Rate	32 kHz, 44.1 kHz, 48 kHz, 88.2 kHz, 96 kHz, 176.4 kHz, 192 kHz		
Bit Depth	Up to 24-bit		

Protocols	
Video Streaming	RTP
Audio Streaming	RTP, up to 7.1 channels AES67, up to LPCM 7.1 channels
Addressing	DHCP, static
Encryption	AES-128
QoS Tagging	RFC 2475
Discovery	Multicast DNS, LLDP, SAP
Management	HTTPS, SSH, Telnet, and WebSockets with TLS
Authentication	IEEE 802.1x: PEAP/MSCHAPv2 or EAP-TLS
IP Multicast	IGMPv2 and IGMPv3 support

Graphics Features	
Text Insertion	Adjustable height/width, scrolling (speed, direction, or static), iterations (up to infinite), positioning, and adjustable color and alpha (transparency) channels.
Slate / Logo Insertion	PNG file format, adjustable aspect ratio (keep or stretch), horizontal/vertical size, screen position; slate mode can be set to off, manual (image always displayed, superimposed on the source signal, and will remain if source signal is lost), auto (image will only be displayed when source signal is lost).

Control	
RS-232	Device control and configuration; supports baud rates from 2400 to 115200 Bidirectional pass-through from control system to network
IR	Pass-through from control system to network Pass-through from network to control system

Connectors	
HDMI	2 - Type A, 19-pin, female, locking
ETHERNET <sup>®</sup>	2 - RJ45, 10/100/1000 Mbps
RS-232 / IR	1 - Euroblock, 6-pin (2 ports); RS-232 on port 1 and 2, IR on port 1 and 2
Power	1 - Euroblock, 2-pin

Indicators and controls	
PWR	1 - LED, tricolor (red, amber, green)
HDMI	2 - LED, bicolor (red, green)
LINK	2 - LED, bicolor (red, green)
Control Buttons	5 - Momentary, tact-type, backlit (blue)  DISPLAY: Triggers CEC or RS-232 display power on/off commands from cross-connected decoders. INPUT: Switches between HDMI inputs. VOLUME: Triggers CEC or RS-232 volume up/down commands from cross-connected decoders. ID: Sends an identification broadcast message over the network to any listening devices.
Reboot	1 - Momentary, tact-type

Power	
PoE	IEEE 802.3af
Consumption	Up to 12 W
External Power Supply (optional)	Input: 110 - 220 V AC, 50/60 Hz Output: 48 V DC, 0.83 A

Environmental	
Cooling System	Front-to-rear airflow, temperature-controlled fans
Operating Temperature	+14 to +122 °F -10 to +50 °C
Storage Temperature	-14 to +140 °F -10 to +60 °C
Operating Humidity (RH)	20% to 95%, non-condensing

Chassis	
Dimensions (H x W x D)	1.34 in x 8.19 in x 4.41 in 34 mm x 208 mm x 112 mm
Weight	1.5 lbs / 0.7 kg
Safety	CE, RoHS, FCC

Certification	
Device	CE, FCC, CB, RoHS
Supply	CE, FCC, cULus, CB, RCM, RoHS

- (1) HDMI 2.0b and HDCP 2.2 are only supported by hardware revision C or later. Previous hardware revisions use HDMI 1.4 and HDCP 1.4.
- (2) Only supported when Video Quality Optimization is set to Video mode.
- (3) Scaling and deinterlacing is not supported at 1080i.
- (4) All VESA resolutions are 60 Hz.
- (5) Maximum distance per hop is 330 ft (100 m), depending upon network configuration.

