

USER MANUAL



Avonic PTZ Camera 12x, 20x, 30x zoom

CM70-IP • CM71-IP • CM73-IP

DISCLAIMER, CONTACT, IP RATING, MARKINGS

Disclaimer

All text, graphics, photographs, trademarks, logos, artwork and computer code (collectively, "Content"), including but not limited to the design, structure, selection, coordination, expression, "look and feel" and arrangement of such Content, contained in this Manual is owned, controlled or licensed by or to Avonic, and is protected by trade dress, copyright, patent and trademark laws, and various other intellectual property rights and unfair competition laws.

Except as expressly provided in these Terms of Use, no Content of this Manual may be copied, reproduced, republished, uploaded, posted, publicly displayed, encoded, translated, transmitted or distributed in any way (including "mirroring") to any other computer, server, Web site or other medium for publication or distribution or for any commercial enterprise, without the prior written consent of Avonic.

Copyright © 2023 AVONIC All Rights Reserved.

The information contained in this Manual is **subject to change without notice**. Visit regularly www.avonic.com to download the latest version of the user manual. Download at least every half year a new version to stay up to date (however, we recommended to do this more often).

Contact Info

For any questions or suggestions, contact your reseller or local distributor of Avonic.

Visit the Avonic website www.avonic.com to find your local Avonic distributor or to download the most recent version of the documentation.

Join Avonic on Social Media



www.Facebook.com/avonicPTZ



www.instagram.com/avonicPTZ



www.Linkedin.com/company/avonic



www.youtube.com/channels/avonic



www.twitter.com/avonic

IP Rating

The IP Rating (ingress protection) for this Product is IP30. This means that the Product has an intrusion protection against solid objects over 2.5mm, e.g. tools & wires and has no moisture protection.

Markings

The Product has Markings. The labels are placed at the bottom of the Product and on the packaging. See the respective figures below:

Figure 1: Markings (Product)



Figure 2: Markings (Packaging top and bottom)

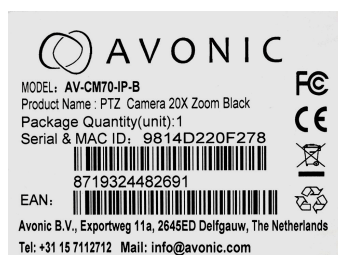

EU DECLARATION OF CONFORMITY

The Avonic Declaration of Conformity is in accordance with applicable EU Directives, Regulations and EN ISO/IEC 17050-1 standard:

Figure 3: EU Declaration of Conformity

Declaration number:	DOCIP 819694	
Name and address of manufacturer / EU-AR:	Avonic Exportweg 11a 2645ED Delfgauw Netherlands	
THIS DECLARATION OF CONFORMITY IS ISSUED UNDER THE SOLE RESPONSIBILITY OF:		
Name and address of manufacturer:	Avonic Exportweg 11a 2645ED Delfgauw Netherlands	
Product identification:	PTZ Camera 12x/20x/30x Zoom White AV-CM7x	
THE PRODUCTS MENTIONED IN THIS DECLARATION ARE IN CONFORMITY WITH:		
EU Community Legislation	Restriction of Hazardous Substances (RoHS) Directive 2011/65/EU [OJEU L174/88-110, 01.07.2011] Electromagnetic Compatibility (EMC) Directive 2014/30/EU [OJEU L96/79-106, 29.03.2014] Ecodesign energy-related products Directive 2009/125/EC [OJEU L285/10-35, 31.10.2009] Low Voltage Directive (LVD) 2014/35/EU [OJEU L96/357-374, 29.03.2014]	
Harmonised standards	Safety of electrical equipment EN 60065:2014 + AC:2016 + AC:2017 + AC:2017 + AC:2018 Electromagnetic Compatibility (EMC) EN 55020:2007 + A11:2011 + A12:2016 EN 55032:2015 + AC:2016 EN 55035:2017 EN 61000-3-2:2014 EN 61000-3-3:2013 Restricted substances in electrical products EN 50581:2012 EN IEC 63000:2018 Ecodesign Regulation (EC) 278/2009 - Ecodesign of external power supplies (EPS)	
Other specifications:		
Notified Body:		
Additional Information:		
SIGNED FOR AND ON BEHALF OF:		
Place and date of issue:	Delfgauw, 24 October 2019	
Signature:		
Name, function:	Walter Harrewijn, CEO	
Company name:	Avonic	

* The CM70 series is also EN 60601-1-2 (2015) certified for medical purposes. See [Safety Instructions > Operation](#).

IMPORTANT INFORMATION

Liability

Avonic will NOT be held responsible for any damage or injury caused by unqualified persons carrying out these tasks, or by not following the instructions in this Manual.

Intended Use and Non-Intended Use

Installation



The following applies to the **installation** of the camera:

- The installation activities in this Manual should ONLY be executed by experienced technicians.
- The installation activities should NOT be executed by minors, mentally disabled persons or other persons not qualified to perform these tasks.





Operation





The following applies to the **operation** of the camera:





- The operational activities described in this Manual should ONLY be executed by people with enough technical knowledge to perform the activities in a safe manner.
- This Product is specifically developed for video conferencing / streaming via internet by companies, institutes and universities. It is NOT meant for private use in the residential area.
- This Product should ONLY be used indoors.
- This Product is certified against EN 60601-1-2 (2015) as class A for medical use in Professional healthcare facility environment and Home healthcare environment. It means that you can use the Product in consultation of medical trained and certified experts as part of a medical certified installation. The Product is NOT certified against the full Medical Device Regulation and has ONLY the EN 60601-1-2 (2015) certificate. Use the Product ALWAYS together with a medical trained and certified expert! Please consult your healthcare provider prior to making any decisions related to your health. The Product can ONLY be used within the EU for medical usage. See the medical certificate on the [Avonic CM70 product website](#).

Important Precautions

	This Product is NOT intended for use where failure of the device could lead to death, personal injury, or severe environmental damage.
	Be sure that you have COMPLETELY READ and UNDERSTOOD ALL information in this Manual before unpacking, installing and using this Product. Keep the Manual safe for future reference or download it from www.avonic.com .
	Failure to follow the SAFETY NOTES as described in this chapter could result in fire, electric shock, injury, or damage to this Product or other property.
	Power this Product ONLY with the included cable and power adapter. Other adapters may not meet applicable safety standards, and could pose a risk of death or injury when connected.

Symbols Used in This Manual

Symbol	Meaning	Description
	Danger	Not following instructions associated with this symbol may lead to personal injury and / or serious damage to the Product.
	Electrical Shock	Not following instructions associated with this symbol may lead to life-threatening situations and / or serious damage to the Product.
	Listed instructions	Not following this information or instructions may lead to injury and/or damage to the product. Read the instructions in the user manual first before you use the product!

Symbol	Meaning	Description
	Important	The information associated with this symbol requires special attention.
	Information	The information associated with this symbol refers to a remark or reference to other documents.
	Instruction	This symbol refers to instructions that must be followed as is documented in the user manual.
	Recycling	Specific parts of the Product can be re-used.

Acronyms

The following acronyms are used in this Manual:

AAE	Aperture Auto Exposure	Automatic Iris F-stop value (aperture) of the camera. This will set the depth of field.
AWB	Auto White Balance	Automatic white balance setting of the camera. This will make the picture warm (yellow) or cold (blue).
BLC	Back Light Compensation	Compensation for filming against back light.
CCM	Customizable Color Matrix	Feature with which you can match the colors from the Avonic CM70 series cameras with cameras from other manufacturers. The colormatrix is a 3x3 "table" that affects red, green and blue in the filmed picture and their relation to it.
CMOS	Complementary Metal Oxide Semiconductor	Type of semiconductor technology used in the fabrication of integrated circuits and sensors. CMOS technology is widely used in various electronic devices such as cameras for example.
DRC	Dynamic Range Compression	The Dynamic Range Compression setting of the camera. The DRC works by compressing the natural dynamic range of the image by taking out the darkest and lightest parts.
EV	Exposure Value	Artificial setting to make the picture lighter.
HD	High Definition	High (video) resolution of 1920 x 1080 pixels.
HDMI	High-Definition Multimedia Interface	Digital audio and video interface used to transmit high-quality audio and video signals between devices, such as computers, monitors, cameras and more.
IP	Internet Protocol	Protocol that govern the way data packets are transmitted over the internet and other networks. IP provides a unique address for each device connected to a network, allowing data to be sent and received between devices across the internet.
MJPEG	Motion-JPEG	Video compression format that compresses each frame of a video sequence individually as a JPEG image. Unlike other video compression formats that use inter-frame compression, MJPEG treats each frame as a separate image, resulting in higher quality images but larger file sizes compared to other video codecs like H.264 or H.265.
NR	Noise Reduction	Camera setting that reduces noise in the picture. Noise is unwanted disturbance that can degrade the quality of the image. These disturbances may appear as random specks, grain, flickering, or distortions in the video footage.
OSD	On-Screen Display	Display menu that appears on your monitor screen when the camera is connected to IP, SDI or HDMI.
PoE	Power over Ethernet	Technology that allows electrical power to be transmitted along with data over an Ethernet cable.
PTZ	Pan / Tilt / Zoom	Directions to which the lens of the camera can move: Pan (horizontal), Tilt (vertical) and Zoom (zooming in to the picture to magnify objects on large distance).
RTMP	Real-Time Messaging Protocol	Protocol used for streaming audio, video, and data over the internet in real-time.
RTSP	Real-Time Streaming Protocol	Protocol used for controlling the streaming of multimedia data, such as audio and video, over IP networks. RTSP enables the delivery of real-time media content from a server to clients, allowing users to access and interact with live or recorded multimedia streams.
SAE	Shutter Auto Exposure	Setting that automatically determines the best configuration for the shutter speed. The higher the shutter speed, the more sharp the picture become.
SDI	Serial Digital Interface	Video transmission standard used in the broadcast and professional video production industry to transmit high-quality, uncompressed digital video and audio signals over coaxial cables.
SKU	Stock Keeping Unit	Stock keeping unit used by Avonic. Every camera has an unique SKU with AV-CM (Avonic Camera).
SRT	Secure Reliable Transport	Open-source streaming protocol designed for transmitting high-quality video, audio, and data over unreliable or unpredictable networks, such as the internet.
TCP	Transmission Control Protocol	Communication protocol in computer networks and the internet. TCP provides a reliable, connection-oriented, and stream-oriented communication between two devices, typically computers or servers.
UDP	User Datagram Protocol	Connectionless communication protocol used in computer networks and the internet. Unlike TCP, UDP does not establish a dedicated connection between two devices before data transmission.

Contents

DISCLAIMER, CONTACT, IP RATING, MARKINGS.....	ii
EU DECLARATION OF CONFORMITY.....	iii
IMPORTANT INFORMATION.....	iv
Liability.....	iv
Intended Use and Non-Intended Use.....	iv
Installation.....	iv
Operation.....	iv
Important Precautions.....	iv
Symbols Used in This Manual.....	iv
Acronyms.....	v
INTRODUCTION.....	9
Purpose of This Manual.....	9
Target Audience.....	9
Document Structure.....	9
SAFETY INSTRUCTIONS.....	10
Intended Use.....	10
Important Precautions.....	10
Handling.....	10
Operation.....	10
Mounting.....	10
Ventilation.....	11
Repair.....	11
Power and Adapter.....	11
Atmospheric Conditions.....	11
PRODUCT OVERVIEW.....	12
UNPACKING.....	13
Package Contents.....	13
Handling Precautions.....	14
Unpacking the Camera.....	14
Return Procedure.....	14
MOUNTING AND INSTALLATION.....	15
Mounting on Wall or Ceiling.....	15
Connecting the Components to the Camera.....	15
Balanced Audio Connection.....	16
Connecting a Controller to a Camera.....	17
Connecting the camera to a local network.....	17
Connecting via USB, HDMI or SDI.....	17
Serial Connecting via RS-232 or RS-485.....	17
Connecting via LAN.....	19
OPERATION.....	20
WebGUI.....	20
Optional Features.....	20
Login.....	20
Preview (LOCAL).....	21
First time usage.....	22
AUDIO.....	25
VIDEO.....	26
Using the Remote Control.....	46
a. Power.....	46
b. Set.....	46
c. Camera Select.....	47

d. Number Keys.....	47
e. Focus + -.....	47
f. Auto/Manual Focus.....	47
g. Zoom + -.....	47
h. Set & Clear Preset.....	48
i. PTZ Keys (up/down/left/right).....	48
j. Home.....	48
k. BLC ON/OFF.....	48
l. Menu.....	48
m. Function Keys (F1/F2/F3/F4).....	48
n. Blank Buttons.....	48
Other Key Combinations.....	49
Tally Light Functionality.....	49
OSD Menu.....	50
1. MENU.....	51
2. SETUP.....	51
3. CAMERA.....	51
3.1 EXPOSURE.....	52
3.2 COLOR.....	52
3.3 IMAGE.....	52
3.4 FOCUS.....	53
3.5 NOISE REDUCTION.....	53
3.6 STYLE.....	53
4. PTZ.....	53
5. VIDEO FORMAT.....	54
6. NETWORK SETTINGS.....	54
7. VERSION.....	54
8. RESTORE DEFAULT.....	54
Using the System Select.....	55
MAINTENANCE.....	56
Camera Maintenance.....	56
Usage Precautions.....	56
TRANSPORT AND STORAGE.....	57
DISPOSAL AND RECYCLING.....	58
TROUBLESHOOTING.....	59
General.....	59
Power Issues.....	59
Image.....	59
No image.....	59
Abnormal image.....	59
Dithering or flickering image.....	59
Color issues.....	59
Autofocus Issues.....	59
Control.....	60
No self-test (PTZ cameras only) and no power LED.....	60
Remote Controller does not work.....	60
Camera does not respond to commands send over IP.....	60
WebGUI.....	60
Cannot enter WebGUI.....	60
Firmware update failed.....	60
APPENDIX A - VISCA SETTINGS AND COMMAND LIST.....	61
VISCA over Serial Connection.....	61
VISCA over IP.....	61
VISCA over IP using the full Sony VISCA protocol.....	63
Camera Return Commands.....	64

Camera Control Commands.....	65
Inquiry Commands.....	70
APPENDIX B - DIMENSIONS.....	73
APPENDIX C - HTTP API.....	74
How to use HTTP API.....	74
Curl.....	75
{'GetEnv'}.....	75
HTTP API code list.....	76
IR Remote Control.....	76
PTZ.....	76
Audio.....	78
Video.....	79
Network.....	86
System.....	87
APPENDIX D - CMOS SENSOR CHARACTERISTICS.....	90
APPENDIX E - DATASHEET (SPECIFICATIONS).....	91
SPECIFICATIONS CM70-IP.....	91
SPECIFICATIONS CM71-IP.....	92
SPECIFICATIONS CM73-IP.....	93
APPENDIX F - LIST OF SUPPORT ARTICLES.....	94
Index.....	95

INTRODUCTION

Purpose of This Manual

This Manual outlines the safety precautions and the instructions for safe unpackaging, installation, operation, maintenance and disposal of the Avonic AV-CM70-IP, AV-CM71-IP and AV-CM73-IP (HD Video Conference) PTZ cameras.



In this Manual, the Avonic AV-CM70-IP, AV-CM71-IP and AV-CM73-IP cameras are referred to as the 'Product'.

Target Audience

This Manual is developed for installation technicians who install the Product at client sites, and for IT professionals who are responsible for operating the Product.

Document Structure

The Manual is subdivided into the following **Chapters**:

1. Introduction
2. Safety
3. Product Overview
4. Unpacking
5. Mounting and Installation
6. Operation
7. Maintenance
8. Transport and Storage
9. Disposal and Recycling
10. Troubleshooting

Additionally, it contains the following

- Appendix A - VISCA Settings and Command List
- Appendix B - Dimensions
- Appendix C - HTTP API
- Appendix D - CMOS Image Sensor Characteristics
- Appendix E - Datasheet (Specifications)
- Appendix F - List of Support Articles

SAFETY INSTRUCTIONS

This chapter contains important safety information regarding the unpacking, installation and use of the camera.

Intended Use



See section [Intended Use and Non-Intended Use](#) on page iv for details.

Important Precautions

	<p>This Product is NOT intended for use where failure of the device could lead to death, personal injury, or severe environmental damage.</p>
	<p>Be sure that you have COMPLETELY READ and UNDERSTOOD ALL information in this Manual before unpacking, installing and using this Product. Keep the Manual safe for future reference or download it from www.avonic.com.</p>
	<p>Failure to follow the SAFETY NOTES as described in this chapter could result in fire, electric shock, injury, or damage to this Product or other property.</p>
	<p>Power this Product ONLY with the included cable and power adapter. Other adapters may not meet applicable safety standards, and could pose a risk of death or injury when connected.</p>

Handling



To prevent the risk of injury, take the following precautions when handling this Product:

- Handle the Product with care. It is made of metal, glass, and plastic and has sensitive electronic components inside.
- The Product can be damaged if dropped, burned, punctured, crushed, or if it comes in contact with liquid.
- Do not pick up and move the Product unit while a tripod is attached. The fitting may break under the weight of the tripod, which may result in injury.
- If you suspect any damage to the Product, discontinue its use, as it may cause overheating or injury.

Operation



The following applies to the operation of the camera:

- The operational activities described in this Manual should ONLY be executed by people with enough technical knowledge to perform the activities in a safe manner.
- This Product is specifically developed for video conferencing / streaming via internet by companies, institutes and universities. It is NOT meant for private use in the residential area.
- This Product should ONLY be used indoors.
- This Product is certified against EN 60601-1-2 (2015) as class A for medical use in Professional healthcare facility environment and Home healthcare environment. It means that you can use the Product in consultation of medical trained and certified experts as part of a medical certified installation. This Product is NOT certified against the full Medical Device Regulation and has ONLY the EN 60601-1-2 (2015) certificate. Use the Product ALWAYS together with a medical trained and certified expert! Please consult your healthcare provider prior to making any decisions related to your health. The Product can ONLY be used within the EU for medical usage. See the medical certificate on the [Avonic CM70 website](#).

Mounting



To prevent the Product from falling down which may cause injuries:

- Set up this Product on a hard, stable surface or mount it to a wall or ceiling.
- ONLY use an Avonic mount for mounting to a wall or ceiling.
- Ensure the mounting construction is capable of supporting four times the weight of the Product. (See 'General Specifications > Weight product' in the Product Datasheet for the exact weight.)
- Use a safety loop or drop protection that prevents the Product from falling if the mounting construction fails.
- During installation, NEVER install a Product above a person.
- Check the installation at least once a year. An improper mounting could cause the unit to fall off, resulting in injury.

Ventilation



To prevent the risk of life-threatening injury or damage to the Product or other property, caused by electric shock or fire hazard due to overheating:

- Maintain adequate ventilation by NOT installing or placing the Product unit in a bookcase, built-in cabinet or any other confined space.
- Ensure that curtains or any other material does NOT obstruct the ventilation.

Repair



Take the following precautions if the Product should be repaired:

- Don't open this Product and don't attempt to repair it yourself. Disassembling the Product may damage it or may cause injury to you.
- If this Product is damaged, malfunctioning, or if it comes into contact with liquid, contact Avonic or an Avonic Authorized Service Provider.
- Repairs by service providers other than Avonic or an Avonic Authorized Service Provider may not involve the use of Avonic genuine parts and may affect the safety and functionality of the device. You can find more information about repairs and service at www.avonic.com.

Power and Adapter



To prevent the risk of life-threatening injury or damage to the Product or other property, caused by electric shock or fire hazard:

- Power this Product ONLY with the included cable and power adapter. Other adapters may not meet the applicable safety standards. They could pose a risk of death or injury when connected.
- Do NOT use damaged cables.
- Do NOT power the Product in a moist / wet environment.
- Before you power the Product, ensure the cable is fully inserted into the power adapter.
- Plug the power adapter directly into a power outlet.
- Do NOT use the power adapter at a moist / wet location.
- Do NOT connector disconnect the power adapter with wet hands.
- Keep the Product, cable, and power adapter in a dry and well-ventilated area when in use.
- Stop using the power adapter and any cables if any of the following conditions exist:
 - The power adapter plug or prongs are damaged.
 - The cable becomes frayed or otherwise damaged.
 - The power adapter is exposed to excessive moisture, or liquid is spilled into it.
 - The power adapter has been dropped, and its enclosure is damaged.

Atmospheric Conditions



To prevent the risk of injury or damage to the Product or other property caused by a potentially explosive atmosphere:

- Do NOT use this Product in an area with a potentially explosive atmosphere, such as areas where the air contains high levels of flammable chemicals, vapors, or particles (such as grain, dust, or metal powders), may be hazardous.
- Exposing this Product to environments having high concentrations of industrial chemicals, including near evaporating liquified gasses such as helium, may damage or impair this Product functionality.
- Obey all signs and instructions.

PRODUCT OVERVIEW

Description

The cameras in the Avonic CM70-IP / CM71-IP / CM73-IP series comprise a high-quality PTZ camera line with simultaneous HDMI, 3G-SDI, USB 2.0 and IP-stream Ethernet outputs. The cameras of this line are designed for fixed, indoor installations.

The cameras include a rich feature set, that is usually found on broadcast-grade cameras. For example: a user-adjustable Color Matrix and SRT streaming (licensed premium functions).

The cameras have the ability to deliver outstanding quality under low light conditions, thanks to its high-quality SNR CMOS sensor. The sensor delivers Full HD 1080p60 video.

Each camera can be accessed remotely through a WebGUI, in which the user can set up and operate a specific camera.

Each camera is provided with an On-Screen Display (OSD) menu, an integrated on-screen menu that can be accessed within the camera to change specific functions that effect how the camera processes an image. The OSD Menu is visible on the HDMI, SDI, and USB outputs.



Features

Each camera in the Avonic CM70-IP / CM71-IP / CM73-IP series has the following features:

Lens

20x/12x/30x Optical Zoom glass lens.

Low light

High SNR CMOS combined with Digital Noise Reduction (DNR) for a clear picture, even under very low light conditions.

Full HD 1080p60

Full HD 1920 x 1080p60 resolution and Pristine image quality.

IP-features

The camera can be powered using Ethernet port with PoE (802.3af) functionality, accessed via WebGUI and controlled by VISCA over IP / Onvif for video streaming.

DUAL low latency IP-Stream

H265, H264, optional SRT and MJPEG compression at a bitrate up to 40Mbit, thus enabling Full HD video stream by ultra-low latency over RTSP, RTMP, UDP, Unicast, Multicast support.

Outputs

3G-SDI, HDMI, USB 2.0 (1080p30) and IP.

Control

Camera control using common protocols: VISCA, Pelco-D / P via RS-232, RS-485, IP (VISCA), Onvif or IR.

Audio embedding

Balanced audio input with embedding into IP stream, SDI and HDMI outputs.

Optional Premium features

SRT streaming, Tally light, configurable Color Matrix. License AV-LC70-1 (sold separately).

UNPACKING

This chapter provides details about the contents of a complete product package, along with instructions on how to safely unpack the product and, if needed, initiate a product return.

Package Contents

The following tables contains an overview of the package contents of the Product.

No.	Quantity	Description	Avonic SKU
1	1 pc	PTZ Camera	AV-CM70/71/73-IP-B/W
2	1 pc	Remote Control	AV-CM40-RC
3	1 pc	USB cable type A to type A	AV-USB20-AA
4	1 pc	Power Adapter 12V/A (GME Technology (Shenzhen) Co., Ltd , model number: GME24A - 120200FDS2)	AV-CM40-PSU
5	1 pc	RS-232 9-pin D-Sub female to DIN -8 male	AV-CM-RS-232
6	1 pc	5-way Phoenix Balanced audio con. (CTBP92HE/5)	AV-PHNX-5
7	1 pc	2-way Phoenix RS-485 connector	AV-PHNX-2

Each item is visualized below and referenced by the associated number in the table above:



Figure 4: Package Contents

Power Adapter Usage

* Use only the Power Adapter of GME Technology (Shenzhen) Co., Ltd with model number: GME24A - 120200FDS2 in combination with the CM70 series camera. Using another Power Adapter may lead to injury and/or damage to the product. See the picture of the Power Adapter label at the left:



Figure 5: Power Adapter label



Figure 6: Power plugs

* The power plug cable included with the power adapter may vary based on the image provided in the package contents. This depends on the electrical system that is used in the country you live in. This is the case for UK and Australian customers for example. See the picture above at the right.

Handling Precautions



Always take the camera by its base and do **not** move the position of the lens manually. See below.

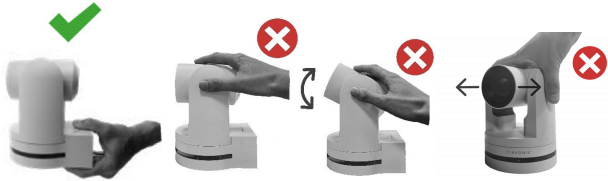

Figure 7: Handling Precautions

Unpacking the Camera



Execute the following steps to unpack the camera and associated components:

1. Verify the following on and inside the box:
 - If the box and the plastic camera bag are sealed.
 - If the camera is placed inside the box in its protective foam.
 - If the contents of the box matches exactly the items as described in [Package Contents](#) on page 13.
 - If this is NOT the case, contact Avonic and stop here. See also the picture below:



Figure 8: Camera in plastic bag and protective foam

2. Break the seal of the sealed camera bag.
3. Take the camera out of the bag. Be sure to follow the [Handling Precautions](#) on page 14 while doing so.
4. Install the camera following the steps as outlined in chapter [MOUNTING AND INSTALLATION](#) on page 15

Return Procedure



If, for any reason, you have to return the camera to Avonic, Execute the following steps:

1. Place the camera back in its protective foam. Verify that the lens is in HORIZONTAL position!
2. Place the camera with **all** of its components in the box.
3. Verify that the contents of the box **exactly** matches the items as outlined in [Package Contents](#).
4. Follow [Transport and Storage](#) and contact [Avonic](#) for the Return Procedure.

MOUNTING AND INSTALLATION

This chapter outlines how to mount and install the Product in a correct and safe manner.

These steps are subdivided into the following groups, each of which is documented in a separate section:

1. Mounting on Wall or Ceiling
2. Connecting the Components to the Camera
3. Connecting a Controller to a Camera
4. Connecting the camera to a local network



Take the following precautions to prevent the Product from falling down which may cause injuries:

- Set up this Product on a hard, stable surface, or mount it to a wall or ceiling.
- ONLY use an Avonic mount for mounting to a wall or ceiling.
- Ensure the mounting construction is capable of supporting four times the weight of the Product. (See 'General Specifications > Weight product' in the Product Datasheet for the exact weight.)
- Use a safety loop or drop protection that prevents the Product from falling if the mounting construction fails.
- During mounting and installation, NEVER install a Product above a person.
- Check the installation at least once a year. An improper mounting could cause the unit to fall off, resulting in personal injury.

Mounting on Wall or Ceiling

The following accessories (AV-MT200 and AV-MT250) are separately available if the client wants to mount the camera to the wall or ceiling. Contact your Avonic reseller or local distributor for purchasing details.



Wall mount (AV-MT200)

SKU white: AV-MT200-W

SKU black: AV-MT200-B



Ceiling mount (AV-MT250)

SKU white: AV-MT250-W

SKU black: AV-MT250-B



Visit www.avonic.com to download instructions for mounting the camera to the wall or ceiling using the accessories AV-MT200 or AV-MT250.

Connecting the Components to the Camera



Execute the following steps to connect the components to the camera:

1. Connect all provided components (see [Package Contents](#)) to the ports at the rear of the camera. The figure below shows the applicable ports.



Figure 9: Camera Ports

1. Kensington Lock
2. Balanced Audio Line in 5-pin Phoenix connector
3. RS-485 two-wire serial communication with 2-pin Phoenix connector
4. System Select (see [Using the System Select](#))
5. RS-232 mini-DIN-8 IN (connect the supplied RS-232 cable)
6. RS-232 mini-DIN-8 OUT for daisy chaining RS-232 connection
7. BNC 3G-SDI output, SMPTE 425M level A.
8. HDMI Type A
9. USB2.0 Type A, UVC video output and control
10. RJ45 Ethernet, with PoE (48Vdc, 0.25A, comply with LPS/PS2 circuits)
11. DC 12V power with locking screw (connect the supplied DC PSU)
12. Power ON/OFF
13. Fall protection eye

Cable	(average) cable length	maximum cable length
RS-485	2 meter	1200 meter
RS-232	2 meter	10 meter
Balanced Audio	2 meter	100 meter
3G-SDI	2 meter	100 meter
HDMI	2 meter	15 meter
USB 2.0	2 meter	5 meter (A to A: 2 meter)
RJ45 Ethernet	2 meter	undefined
DC12V power	2 meter	fixed



If you use these cables for [medical purposes](#), it is important that the maximum cable length must **NEVER be exceeded**.

2. If you have connected the power cable to the camera, set the power switch at the back of the camera to the 'ON' position. If you use a PoE Ethernet connection, ensure that the Power switch is always 'ON'.

The camera starts initializing by first rotating the Pan-Tilt to the maximum top right position and then to the center after empowering.



If position preset '0' has been stored, this is the position that will be called after initialization.

The current IR-channel setting and IP Address of the camera are displayed on the [OSD Menu](#). From this point onwards, the user can start controlling the camera.

Balanced Audio Connection

To connect balanced audio to the camera, you need the following:

- Double Male XLR cable to connect to a 5 pins phoenix connector (CTBP92HE/5: see [package contents](#)).
- Audio input device with multiple XLR input/ outputs, such as a mixer.
- PoE (CAT) cable for streaming. See below:

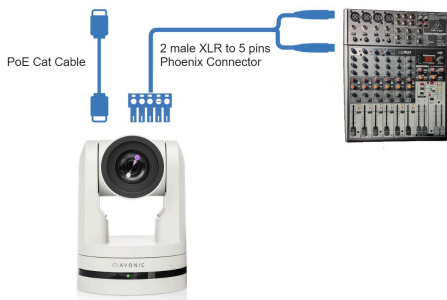

Follow the instructions below to connect the audio cable to the phoenix and the XLR connectors.

1. Connect the wires of the audio cable as is shown in picture 1 to both XLR connectors. Note that the pictures of the connector's back are **mirrored!**
2. Connect the wires of the other side of the audio cable as is shown in picture 2.



If you use a balanced audio cable for **medical purposes**, it is important that the maximum cable length should **NOT exceed 100 meters**.



The colors of the wires could be different in your audio cable according to the pictures (XLR and Phoenix connector) below. You need to know which one are the right and left channels and which one is the GND (ground).

Picture 1: XLR connector

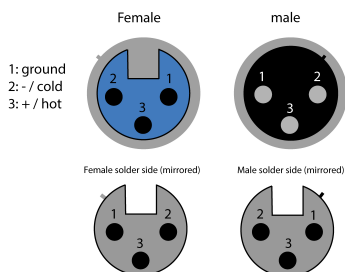

Picture 2: Phoenix connector

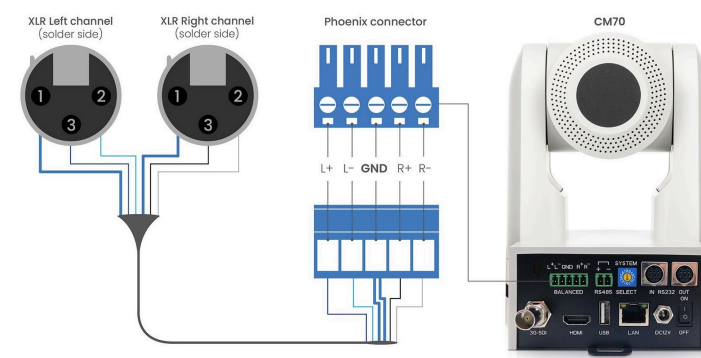

Connecting a Controller to a Camera

You can connect one or more cameras to a VISCA (serial) controller.



See <https://avonic.com/en/product-categorie/controllers/> for an overview of the available controllers.

A controller gives you direct control over the most important camera settings (e.g., Pan, Tilt, Zoom, Focus, White Balance). You can access all other settings through the **OSD Menu** of the camera using the controller.

Connecting the camera to a local network

The camera can be connected via a serial connection to USB, HDMI, SDI, RS-232, RS-485, or via a LAN Ethernet connection. Each of these options is outlined below.

Connecting via USB, HDMI or SDI



Execute the following steps to connect the camera to a desktop or a (computer) monitor via USB, HDMI or SDI:

1. Connect the camera to the desktop or monitor via the USB, HDMI or SDI port (see figure above).
2. Open the Windows Camera app or a third-party camera app.
3. Open the Settings.
4. Select the camera you just connected, or click on the option / icon to change the camera to the camera you just connected.
5. Press the **MENU** button on the provided IR Remote Control to open the **OSD Menu**.



See [Using the Remote Control](#) for more information on how to use the Remote Control.



If you use an RS232 cable for **medical purposes**, it is important that the maximum cable length (SDI: 100 meter, HDMI: 15 meter and USB: 5 meter with A to A: 2 meter) must **NOT be exceeded!**

Serial Connecting via RS-232 or RS-485

COM Port Settings

In default working mode, the camera can connect to a VISCA controller via an RS-232 or RS-485 serial interface. The applicable COM port settings are (where '*' stands for 'Default value'):

RS-232

- Baudrate: 2400/4800/9600*/115200
- Start bit: 1 bit
- Data bit: 8 bits
- Stop bit: 1 bit

RS-485 (half-duplex mode)

- Baudrate: 2400/4800/9600*
- Start bit: 1 bit
- Data bit: 8 bits
- Stop bit: 1 bit

RS-232 Interface



Connect the controller to the back of the camera via the RS-232 cables as shown below:

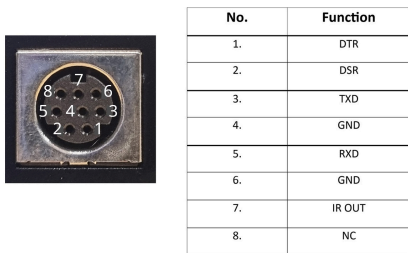

Figure 10: RS-232 Interface (Mini DIN-8)

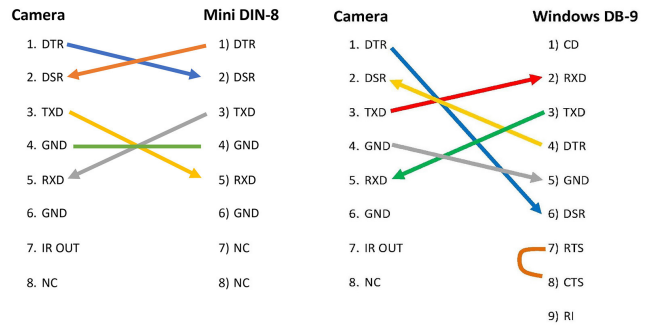

Figure 11: RS-232 Cable and Interface Connection (Mini DIN-8 and Windows DB-9)

RS-232 Network Connection



Execute the following step to connect the controller to the back of the camera(s) via RS-232:

1. Make the connection using **daisy chaining** network architecture. Keep in mind that the maximum cable length for RS-232 is 10-15m.

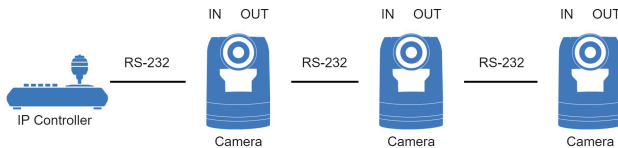

Figure 12: RS-232 Network Connection Diagram



For a connection **between** the Avonic cameras you need a (3rd party) RS-232 mini DIN -8 male to male cable since both RS-232 ports at the back of the camera are only suitable for these kind of connectors.



If you use an RS-232 cable for **medical purposes**, it is important to note that the maximum cable length must **NOT exceed 10 meters**.

RS-485 Interface



Connect the controller to the + and - at the back of the camera via the RS-485 cables, as shown below. Note that the color of the connecting cables (red and black in the figure) may vary.

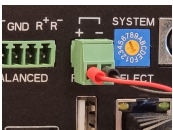

Figure 13: RS-485 Interface

RS-485 Network Connection



Execute the following steps to connect multiple cameras to RS-485:

1. Attach the cameras to a 2-wire twisted pair bus (maximum length 1200m) that is terminated at both ends with a 120Ω-impedance resistor.
2. Ensure that the maximum distance from the bus to the back of the camera or controller is 5m. If you use only ONE camera, the impedance resistor is not needed.

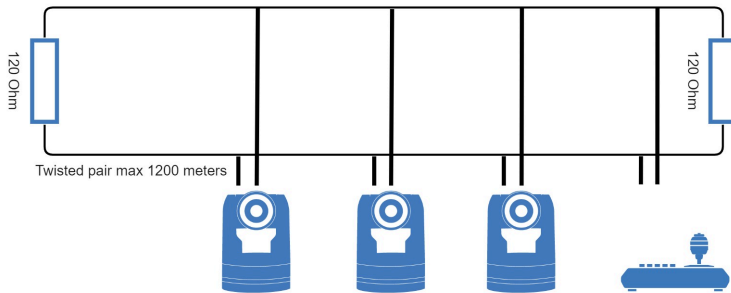

Figure 14: RS-485 Network Connection Diagram



If you use an RS-485 cable for **medical purposes**, it is important to note that the maximum cable length must **NOT exceed 1200 meters**.

Connecting via LAN

Avonic IP cameras can be controlled by any device using the Visca over IP protocol (see the command list in [Appendix A - VISCA Settings and Command List](#)).

Settings

By default, the IP address of the camera is "192.168.5.163" with "admin" for both the username and password.

The control parameters for the cameras are as follows:

- IP Address: 192.168.5.163
- Username: admin
- Password: admin
- TCP or UDP port: 1259

IP (Network) Connection



Execute the following steps to connect an Avonic PoE camera to a LAN:

1. Use a standard (PoE) switch. If the unit is simultaneously connected to both PoE and its own power supply, the power supply will take priority. If the power supply is disconnected when PoE is present, the camera will remain operational without interruption.
2. Ensure that addressing is done via IP. When using VISCA over IP, the 'x' in all the '8x' addresses is always '1', where the Visca address in a Visca over IP environment is always 1. (See [Appendix A - VISCA Settings and Command List](#) for more information.)

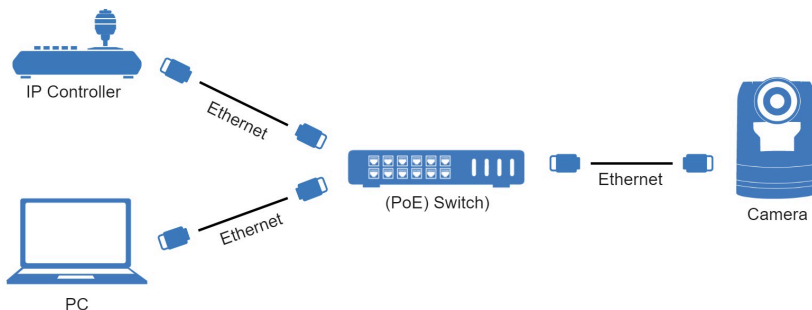

Figure 15: IP Network Connection Diagram

OPERATION

This chapter describes all the camera features to help you to understand how the camera can be used. This is subdivided into the following sections:

1. [WebGUI](#)
2. [Using the Remote Control](#)
3. [Other Key Combinations](#)
4. [OSD Menu](#)
5. [Using the System Select](#)



If you want to read more about the functionality of the camera than is documented in this chapter, it is recommend to read the [support articles](#) from the list in appendix F.

WebGUI

You can access change settings in the camera by using the WebGUI. The WebGUI can be accessed over IP using your local network.

Optional Features

For this Product there are some optional features in the WebGUI that are only available when you purchase an optional license. This optional license ([LC70-1](#)) is available at the accessories page of our website. The following features are optional:

1. [SRT \(Secure Reliable Transport\)](#) see also [SRT](#) on the website
2. [CCM \(Customizable Color Matrix\)](#)
3. [Tally Light functionality](#)

Login

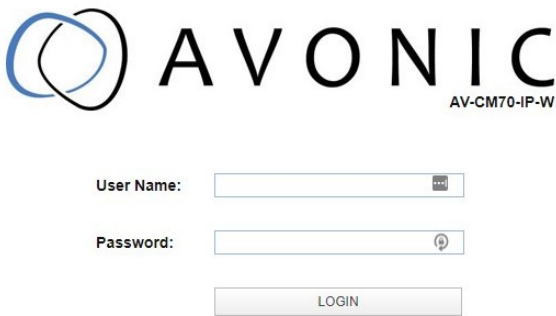

Figure 16: WebGUI > Login



Execute the following steps to log on to the WebGUI:

1. Open your web browser. Enter the default IP address "192.168.5.163". The "Login" screen appears.
2. Enter "admin" for both the Username and Password and Click **LOGIN** to continue. There is also a possibility to automatically fill in the Username and Password (see [User](#)).



- If **DHCP** is enabled and no **DHCP** server is available, the camera will automatically appoint an IPv4 link-local address between **169.254.0.0** and **169.254.255.255**. The IP address is shown on the screen at start-up
- If you don't know the cameras IP address read: [How do I know the IP address assigned to my camera?](#)

After a successful logon, the WebGUI is displayed. Here, you can select various tabs that are outlined below.

Preview (LOCAL)

In this tab, you can see a preview of the camera IP video output.

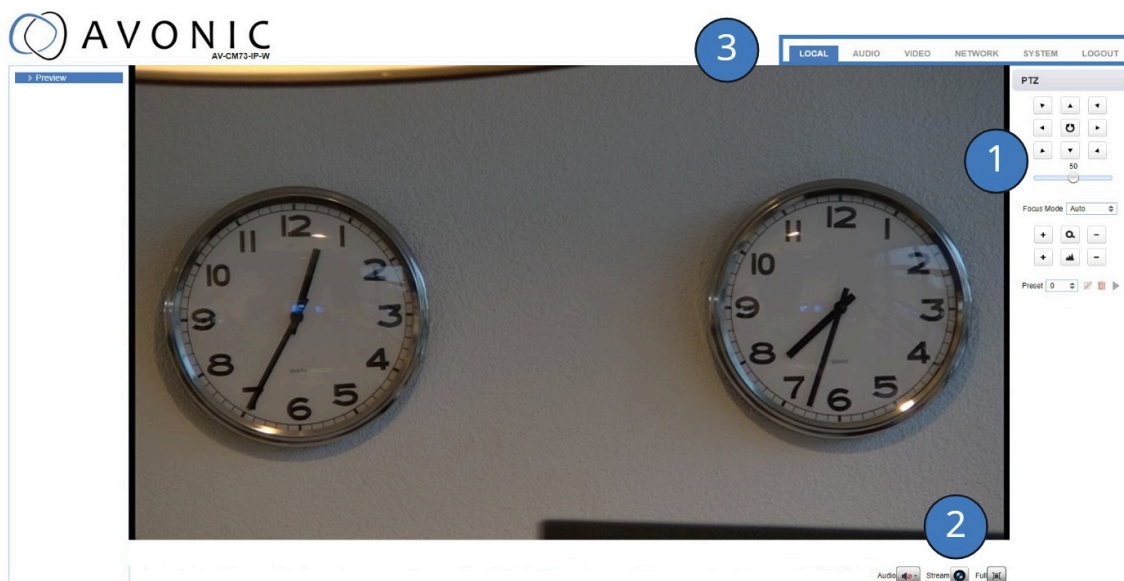

Figure 17: WebGUI > Preview

Next to the preview you see:

1. PTZ keys to move the lens of the camera and Focus keys (works only when the focus is set to manual). You can adjust the PTZ speed (the speed when the camera moves) by using the bar below the PTZ keys.
2. • Audio icon to set the audio to ON (Connect first an audio cable to the [balanced audio](#) input of the camera). Note that you first have enabled the [Audio Enable](#) at the Audio tab of the WebGUI.
 - Stream icon to switch the main and sub stream. Click the icon to switch to the sub stream and click again to turn back to the main stream.
 - Click the Full icon to switch to full screen. Press ESC to turn back to WebGUI Preview.
3. On top: The main tabs to enter different pages of the WebGUI.



The Preview feature works **ONLY** if the main or sub stream is set to 'H264' (see [VIDEO - Camera Settings](#)).

Set, Call and delete presets



To set, call and delete presets do the following:

1. Set the camera in the desired position with the desired zoom and focus level.
2. Type the number of the preset under Preset and click on the **SET** icon.
3. To call a preset, select the number of that preset and click the **RUN** icon.
4. To delete a preset, select the preset number of that preset and click the **CLEAR** icon.

The presets stores the Pan, Tilt position as well as zoom level (no exposure, or white balance settings). If manual focus is chosen, the focus position is also stored. If you use preset 0 to establish a preset position, be aware that upon restarting the camera, the lens will automatically adjust to the designated camera position associated with preset 0. Delete preset 0 to start the camera with the lens straight forward.

Next to the preset icons there is also a "Home" icon (at the center of the PTZ buttons). If you click on that icon, the camera will zoom out and move to a position with the lens straight forward. The "Home" icon cannot be used as a (normal) preset and affects, like the presets, only the Pan, Tilt and Zoom position of the camera.

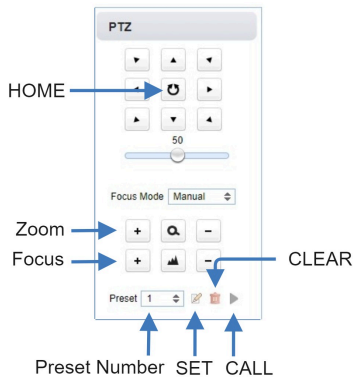

First time usage

If you are using the camera for the first time, it is helpful for you first to setup the basic camera settings before explaining the functionalities of the camera in detail. According to the light conditions in your room or on stage, you can follow instructions at:

1. [Basic Camera Setup](#)
2. [Basic Camera Setup using \(semi\)manual settings](#)

Basic Camera Setup

Do you have changing light conditions? Follow instructions below to set up the basic camera settings. After that you can read more about the functionality in this chapter.

<h3>1. Connect cables</h3> <ul style="list-style-type: none"> • Connect a CAT6a cable to the ethernet port of the camera and a (PoE) network switch. If you use a standard switch, connect also the power cable. • Connect a HDMI cable to the camera and a monitor. • Turn the ON/OFF button at the back of the camera to ON. When the camera starts, the lens turns from back to forth and will finish with the lens straight forward. This will take a few seconds. 	<p>The image shows the back panel of the camera with three blue arrows pointing to the CAT6a port, the HDMI port, and the ON/OFF button.</p>
<h3>2. Login and change output resolution</h3> <ul style="list-style-type: none"> • Use the standard IP address and login to the WebGUI. • Navigate to Output Format and change the video out format when your monitor does not support the standard video resolution (1080p60). Click SAVE to save the new resolution format. • You can use also the System Select at the back of the camera to change the video output format. 	<p>The screenshot shows the 'Output format' section of the WebGUI. The 'Video Out Format' is set to '1080P60'. A blue arrow points to the dropdown menu, and another blue arrow points to the 'SAVE' button.</p>
<h3>1. Focus</h3> <ul style="list-style-type: none"> • Navigate to Video > Camera Settings > Focus in the WebGUI. • Choose Focus Mode > Auto • At AF-Zone choose Moving Objects or Meeting. This depends on the person or object to be filmed: <ul style="list-style-type: none"> • Moving Objects: For a person or object that is moving a lot in any direction in the room or on stage. • Meeting: for general meeting purposes where the person or object in the room or on stage is not moving a lot. • If you have chosen education tracking or moving objects, set the AF-Sensitivity to high. You can leave it to low or middle when you have chosen Meeting at AF-Zone. 	<p>The screenshot shows the 'Focus' settings in the WebGUI. The 'AF-Mode' is set to 'Meeting' and 'AF-Sensitivity' is set to 'Low'. Blue arrows point to the 'Meeting' option in the AF-Mode dropdown and the 'Low' option in the AF-Sensitivity dropdown. A red note says '*Click the "Refresh" Effective after chs'.</p>

2. Exposure

Navigate to **Exposure** tab and set the **Gain Limit** (G.Limit). The higher the Gain Limit, the lighter the picture.

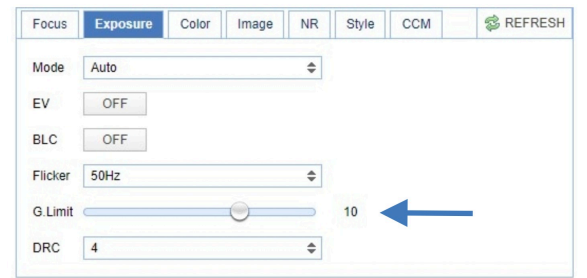

3. Color

Navigate to the **Color** tab and set the **WB Mode** to Auto.



4. Image

Navigate to **Image** tab and set the **sharpness**. The higher the number, the more sharp the picture will become.

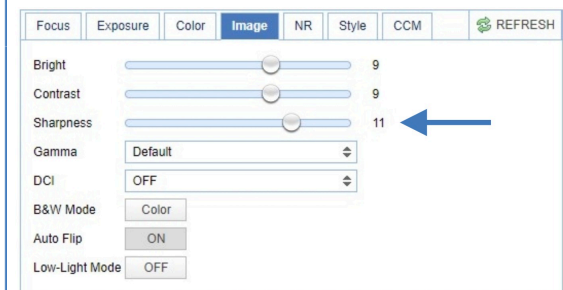

5. Noise Reduction

Navigate to **Noise Reduction** tab and set the **NR-2D** to Auto.



Basic camera setup using (semi)manual settings

Do you have fixed light conditions? Or is the filmed person or object not clear towards the background and the autofocus has difficulties to find the correct focus? Then a (semi)manual setup is useful. Follow instructions:

1. Connect cables

- Connect a CAT6a cable to the ethernet port of the camera and a (PoE) network switch. If you use a standard switch, connect also the power cable.
- Connect a HDMI cable to the camera and a monitor.
- Turn the ON/OFF button at the back of the camera to ON. When the camera starts, the lens will turn from back to forth and will finish with the lens straight forward. This will take a few seconds.



2. Login and change output resolution

- Use the **standard IP address** and login to the WebGUI.
- Navigate to Output Format and change the video out format when your monitor does not support the standard video resolution (1080p60). Click SAVE to save the new resolution format.
- You can also use the **System Select** at the back of the camera to change the video output format.

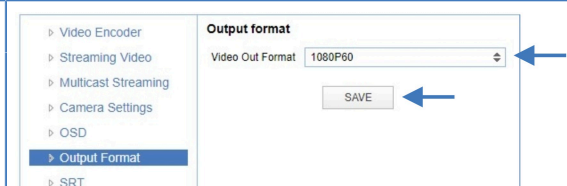

1. Focus

- Navigate to Video > Camera Settings > Focus
- If you have difficulties to focus, choose Focus Mode > Manual. Otherwise set the **Focus Mode** to Auto and choose at AF-Zone > Moving Objects if the filmed person or object is moving a lot, or Meeting for general meeting purposes.
- Set the **AF-Sensitivity** to high if you have chosen Education Tracking or Moving Objects. Otherwise you can leave it to low.

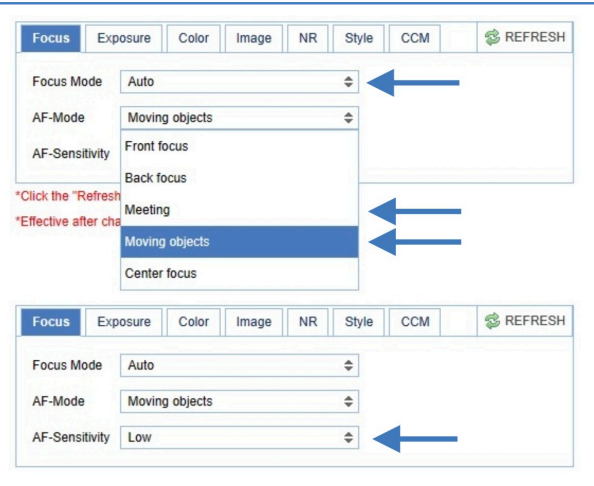

2. Exposure

- Navigate to the Exposure tab
- Choose one of the following at Mode:
 - **SAE**: Do you have fast moving persons or objects before the camera? Choose this mode to set the shutter speed.
 - **AAE**: Do you need more depth of field, because the distance between the camera and filmed object is large? Choose this mode to set the Iris (F-stop).
 - **Bright**: Do you have challenging light conditions? Choose this mode to set the artificial brightness.
 - **Manual**: Do you have fast moving person or object on large distance? Choose Manual to set the shutter speed and the Iris (F-stop).

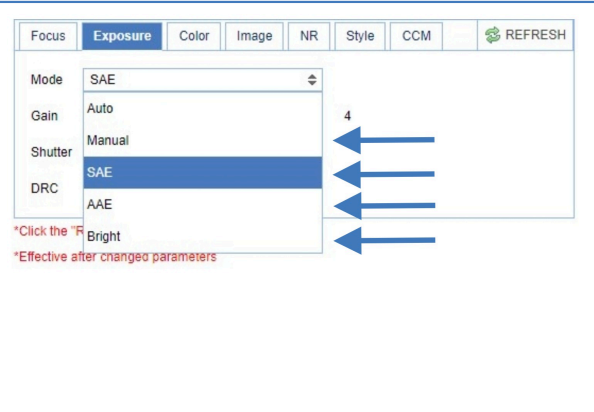

3. Color

- Navigate to the Color tab
- Choose at **WB Mode** one of the White Balance values (2400K ~ 7100K).
 - Do you have a lot of yellow light? Set the value of the WB Mode approximately between the 5000K and 7100K.
 - Do you have a lot of blue light? Set the value of the WB Mode approximately between the 2400K and 3300K.
- If needed change the **Hue** to compensate.

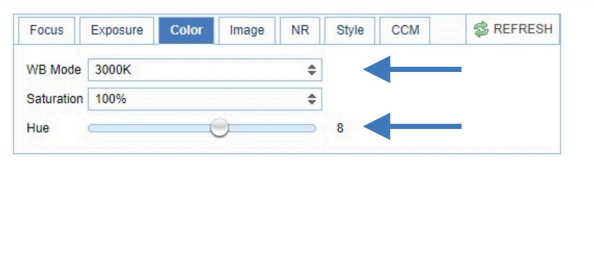

4. Image

- Navigate to the Image tab and set the **sharpness**.
- If needed change also the **bright** and **contrast** settings to add more brightness to the picture.

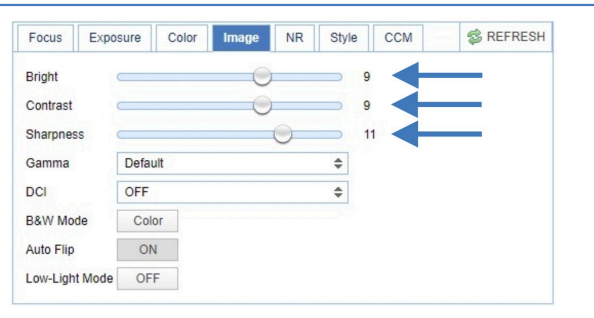

5. Noise Reduction

- Do you have a lot of noise in the picture? Navigate to the Noise Reduction tab and change the **NR-2D** (still-standing objects) and the **NR-3D** (moving objects) to smooth the picture over.

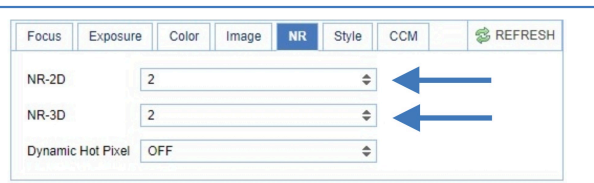

AUDIO



Connect first an audio cable with XLR connectors to the 5 pins Phoenix connector and connect the cable to the camera. See [Balanced Audio Connection](#) on page 16

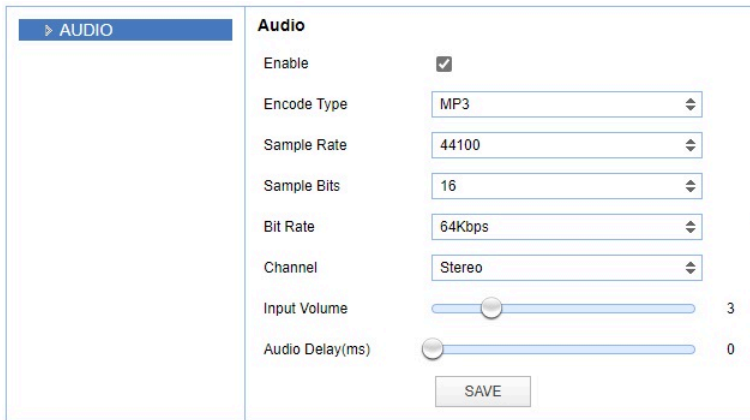

Figure 18: WebGUI > Audio



Make your settings as follows:

1. Enable (checked) or disable (blank) embedding of audio input (camera rear).
2. Select the encoding type: mp3, AAC or G.711A.
3. Select the sample rate: 16000, 32000, 44100 or 48000.
4. Set the sample bits always to 16.
5. Select the Bitrate: 32, 48, 64, 96 or 128 Kbps.
6. Select the Channel: Mono or Stereo.
7. Set the Input Volume: 1 ~ 10.
8. Set the Audio Delay (ms): 0 ~ 200.
9. Click **SAVE** to apply your settings. A small confirmation dialogue appears in the bottom right corner.



Make sure to **enable audio** and to click at the **audio** button on the bottom of the "Preview page" of the WebGUI.

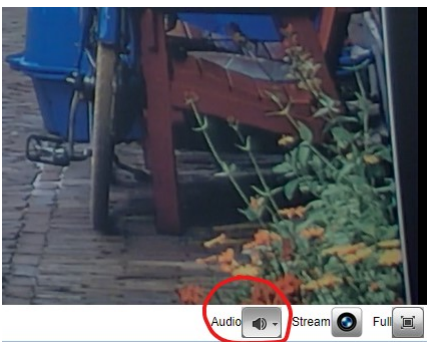

VIDEO

You can use the VIDEO tabs to define your settings for the video output, including the main settings of the camera's OSD.

VIDEO - Video Encoder

Figure 19: WebGUI > VIDEO > Video Encoder

The Video Encoder settings are listed below.

Video Encoder Option	Main Stream	Sub Stream
Compressed Format	MJPEG/ H.264/ H265	MJPEG/ H.264/ H265
Profile	BP/ MP/HP	BP/ MP/HP
Image Size	1920*1080/1280*720	1920*1080/1280*720/ 320*180/ 320*240/ 640*360
Rate Control	CBR (constant bit rate) / VBR (variable bit rate) depending on format	
Image quality	Fixed at 'best'	Fixed at 'good'
Bit Rate(Kb/s)	64-40960	64-40960
Frame Rate (F/s)	5-60 frames per second	5-30 frames per second
I FrameInterval	1-300	1-150
I Framemin. QP	10-51	10-51
Streamname	live/av0	live/av1
RTSP Link	rtsp://<ip-address>/live/av0	rtsp://<ip-address>/live/av1
RTP Package	Small Package (standard MTU size, 1500 bytes) Big Package (approx. 60kb MTU size)	



NDI uses the **Main Stream** of the camera. Execute the following steps to save your settings:

1. Click **SAVE** to apply your settings. A small confirmation dialogue appears in the bottom right corner.
2. Reboot the camera if you changed RTP package.



Read this [article](#) from Youtube and the [article](#) from Facebook for setting up a correct stream, if you want to stream via Youtube or Facebook.

VIDEO - Streaming Video

Figure 20: WebGUI > VIDEO > Streaming Video

The recommended Streaming Video settings are listed below. See for more [Streaming](#) on the website.

Stream Option	Main Stream	Sub Stream
Enable	Mark checkbox to enable	Mark checkbox to enable
Protocol Type	RTMP, SRT	RTMP, SRT
Host Address	192.168.5.11	192.168.5.11
Host Port	1935	1935
Stream Name	live/av0	live/av1
User Name	Empty is default setting	Empty is default setting
Password	Empty is default setting	Empty is default setting
Password for stream encryption*	Empty is default setting	Empty is default setting
Crypto Key Length in bytes	0, 16, 24, 32	0, 16, 24, 32



Execute the following steps to save your settings:

1. Mark the checkbox to enable and select RTMP or SRT as Protocol Type. You need an [optional license](#) if you want to use SRT.
2. (* in the table) Enter a value for **Password for stream encryption** if the selected **Protocol Type** is "SRT". This is the **Caller Mode**. For the **Listener Mode** see [Video - SRT](#).
3. Change the **Host Address** to the IP address of the camera.
4. Click **SAVE** to apply your settings. A small confirmation dialogue appears in the bottom right corner.
5. Start a video streaming application like VLC mediaplayer, Daum Potplayer etc.
6. At **Media > Open Network stream** type rtmp://192.168.5.11/live/av0 or rtsp://192.168.5.11/live/av0 (or live/av1 if you use the substream) and click Play.

VIDEO - Multicast Streaming

If you want to stream your video (live) to a selective group of hosts inside a network, then multicast streaming is recommended. Multicast streaming allows you to send data (video) to a group of hosts in a network simultaneously with limited network load. For this you need a connection to a switch with the possibility for multicast streaming to send the video stream. A connection of the clients to this multicast switch is needed to request the video stream from the switch. See the picture below:

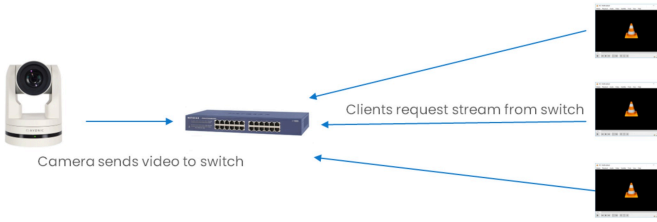

Next to multicast, there is also unicast allowing you to stream video (via RTSP) to one single users IP address. For more information read also [Unicast, Multicast and Broadcast](#) on the website.

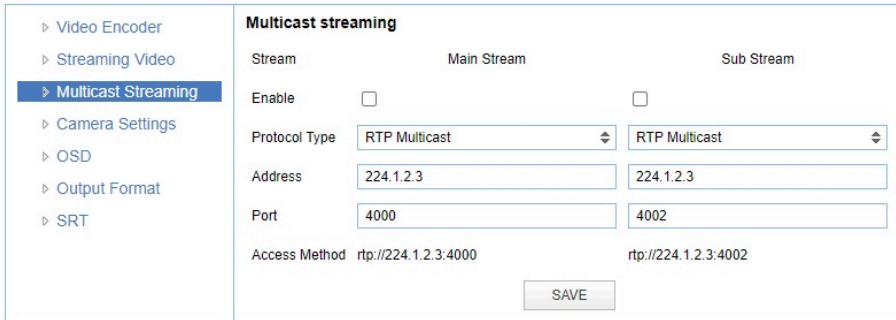

Figure 21: WebGUI > VIDEO > Multicast Streaming

The recommended Multicast Streaming settings are listed below.

Stream Option	Main Stream	Sub Stream
Enable	Mark checkbox to enable/ disable	Mark checkbox to enable/ disable
Protocol Type	RTP Multicast/ TS Multicast/ TS Unicast	RTP/ TS Multicast/ TS Unicast
Address (multicast)	224.0.0.0~ 239.255.255.255	224.0.0.0~ 239.255.255.255
Address (unicast)	Specify the IP address to which you want the Unicast stream pushed.	
Port	4000 (default)	4002 (default)
Access Method	rtsp://224.1.2.3:4000	rtsp://224.1.2.3:4002



Click **SAVE** to apply your settings. A small confirmation dialogue appears in the bottom right corner.

VIDEO - Camera Settings

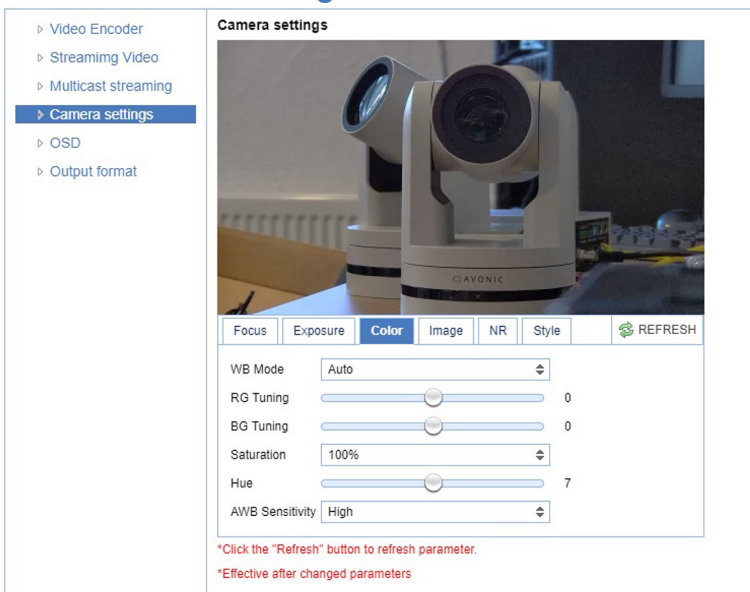

Figure 22: WebGUI > VIDEO > Camera Settings



Execute the following steps to define your camera settings:

1. Use the **Camera Settings** tabs (outlined below) to change the OSD settings as if you are using the remote control.

2. If you have changed a value with the remote control, update the WebGUI using the **REFRESH** button.



A picture is shown **ONLY** if the main video stream is set to H264.

Focus

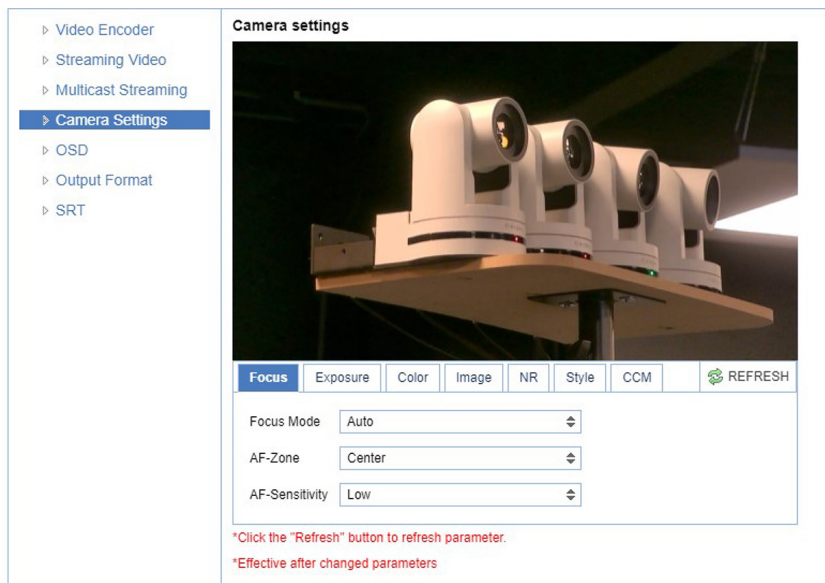

Figure 23: WebGUI > VIDEO > Camera Settings > Focus

The Focus settings are explained below.

Focus Mode

Auto	The camera automatically adjusts the focus position based on the contents of the captured object.
Manual	The user is able to set a fixed focus position manually. This can be useful when the contents of the filmed object are not clear towards the background and the autofocus has difficulty finding the correct focusing.
One-push	The camera will focus once and will keep the focus in that position until another focus command is sent.

AF-Zone

This setting defines the area where the autofocus is aimed at. This setting is not visible at manual focus.

Front Focus:	Focus close to the camera has priority. In the absence of a nearby object or person to focus on, the camera will adjust its focus to objects or individuals at a greater distance.
Back Focus:	Focus far from the camera has priority. If there is no object or person to focus on from far away, the camera will focus on an object or person closer to the camera.
Meeting:	For general meeting scenarios. Focus straight before the camera, but focussing in the whole room or stage is considered.
Moving Objects:	For focussing in the whole room or on stage, but re-focussing is done when the object or person is moving around. (This is the default autofocus mode.)
Center Focus:	Focus straight forward at the middle of the room or on stage and re-focussing is done when the object or person moves.



Autofocus best practices:

- Avoid large objects and "busy backgrounds" in the picture to ensure that the camera will focus on the person or object in the picture.
- If you experience focussing issues, choose another autofocus strategy, or use **Focus Mode > manual** to configure the focus manually.

AF-Sensitivity

The level of speed to which the autofocus responds. This can be useful if you have people walking through the picture. If the setting is 'High', the camera responds immediately. If the setting is 'Low' or 'Medium', the camera will not react to sudden and short changes. The AF-Sensitivity is visible with Focus Mode > Auto and OnePush.



In some cases the autofocus will have some difficulties to focus. We strongly recommend to focus manually to avoid autofocus issues. See also [Troubleshooting/ Image](#) in this manual.

Exposure

If you click in the field after the option 'mode', you will see that you have the following Exposure options: Auto, Manual, SAE, AAE and Bright. These options are outlined below.

Auto Exposure Mode

In Automatic exposure mode, the camera determines the iris and shutter settings. See the settings below:

EV (Exposure Value): ON/OFF and Level

If the light conditions require this, you can create a quick adjustment to your current exposure settings without actually changing the fundamental values like iris and shutter.



Take care to not 'overdo' the settings or the picture will become washed out bright or too dark.

BLC (Back Light Compensation): ON/OFF

Compensation for having to film against bright light directly into the lens. See the pictures below:

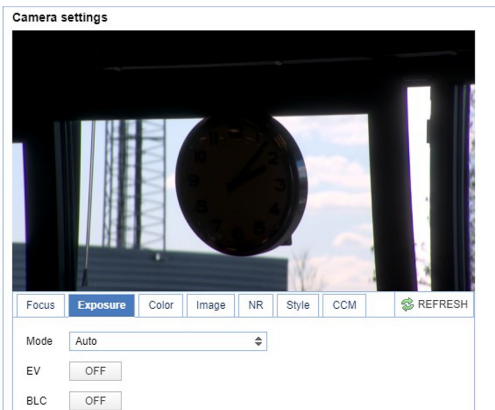

Figure 24: Camera Settings > Auto Expo (BLC OFF)

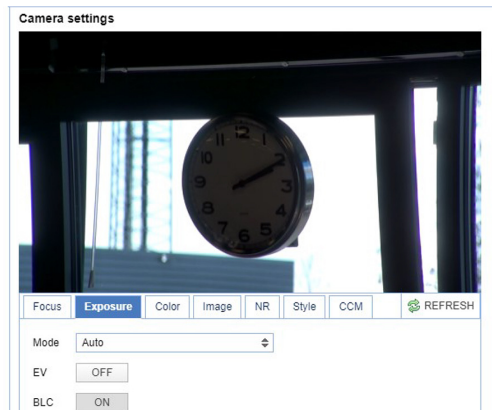

Figure 25: Camera Settings > Auto Expo (BLC ON)

Flicker

This setting handles the flickering of artificial lighting in its operating space. Options are 50Hz, 60Hz and OFF. See for more [Antiflickering](#) on the website.

G.Limit

Gain limit is the maximum level of artificial brightness and contrast that the camera can automatically add to the image. This setting will make a significant difference to the overall picture.



This setting add noise to the picture in dark areas and produce a washed out, greyish picture.

DRC

Dynamic Range Compression has a similar effect on the picture as the above mentioned gain limit. The DRC works by compressing the natural dynamic range of the image by taking out the darkest and lightest parts. This can be a particular helpful setting when the light conditions are challenging. The differences should be clearly visible in dark parts of the image, as they will become lighter/more grey as the level of DRC increases.

Manual Exposure Mode



Figure 26: WebGUI > VIDEO > Camera Settings > Manual Exposure Mode

In Manual exposure mode, you can manually set the shutter, Iris and DRC options.

Shutter

The shutter setting determines the amount of time per second that the sensor is exposed. The range of the shutter speed setting is 1/25th of a second (40 milliseconds) to 1/10000th of a second (0.1 milliseconds). If you shoot a video with a shutter time of 1/25th of a second, you can imagine that the video becomes blurry and overexposed. The faster the shutter is set to open and close, the sharper your filmed object will become. However, the amount of light that falls onto the sensor is also diminished. A higher shutter setting comes in handy when you have regularly a fast moving person or object before the camera. Otherwise keep the shutter as low as possible.



If you are inexperienced or if the light conditions change a lot, it's best practice to keep the camera on the automatic exposure setting.

Iris

The Iris is a part of a lens that regulates the amount of light that passes through the lens and onto the sensor, by altering the diameter of the hole through which the light enters. The diameter of the hole is measured in **F-stop** value. A higher value results in less light, while a lower setting results in more light. This setting affects the length of the depth of field. The higher F-stop you use, the deeper your depth of field. Reason: the smaller the aperture, the more focused the light beams will be, resulting in a more focused image. This means that the light beams are so "concentrated" that the focus point of the lens is at an area far from the lens (making the camera in the picture sharp), but the object at the front (the IR remote control) will be not in the focus area and become out of focus. A higher F-stop value comes in handy when the filmed person or object is in great distance from the camera (and zooming in more is not possible). At the other side the lower F-stop values are useful when the filmed person or object is close to the camera.

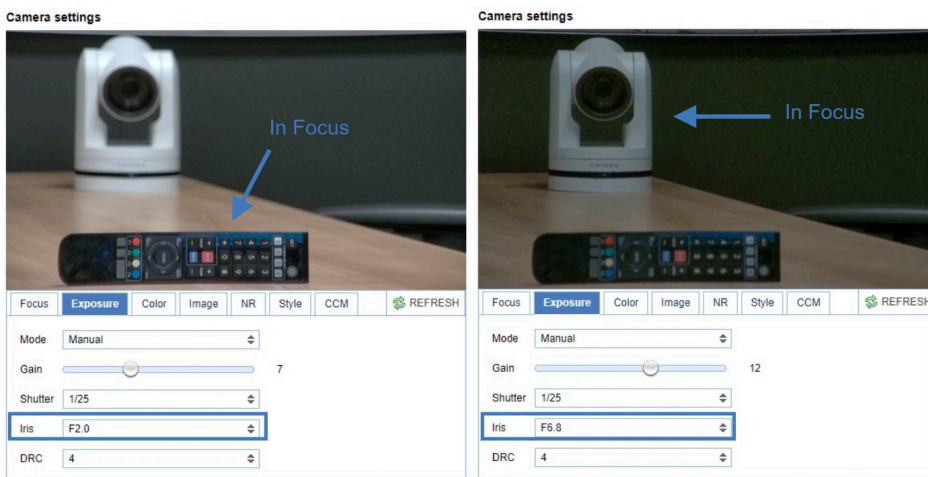

Figure 27: Exposure > Manual with Iris F2.0 (left) and Iris F6.8 (right)

DRC

Dynamic Range Compression has a similar effect on the picture as the above mentioned gain limit. The DRC works by compressing the natural dynamic range of the image by taking out the darkest and lightest parts. This can be a particular helpful setting when the light conditions are challenging. The differences should be clearly visible in dark parts of the image, as they will become lighter/more grey as the level of DRC increases.

SAE Mode (Shutter Auto Exposure)

The shutter speed is user-adjustable in this mode. The camera automatically determines the best Iris F-stop value for an optimal exposure setting. This setting will come with a cost. The higher the shutter speed, the more sharp the picture become, but also the more dark the picture will be.



The shutter speed is the amount of time that each frame of the sensor has been exposed to light.

To compensate for poor lighting conditions, it is possible to adjust the Gain and DRC (Dynamic Range Compression). The DRC works by compressing the natural dynamic range of the image, by taking out the darkest and lightest parts. This can be a particular helpful setting when the light conditions are challenging. The differences should be clearly visible in dark parts, as they will become lighter / more grey as the level of DRC increases.

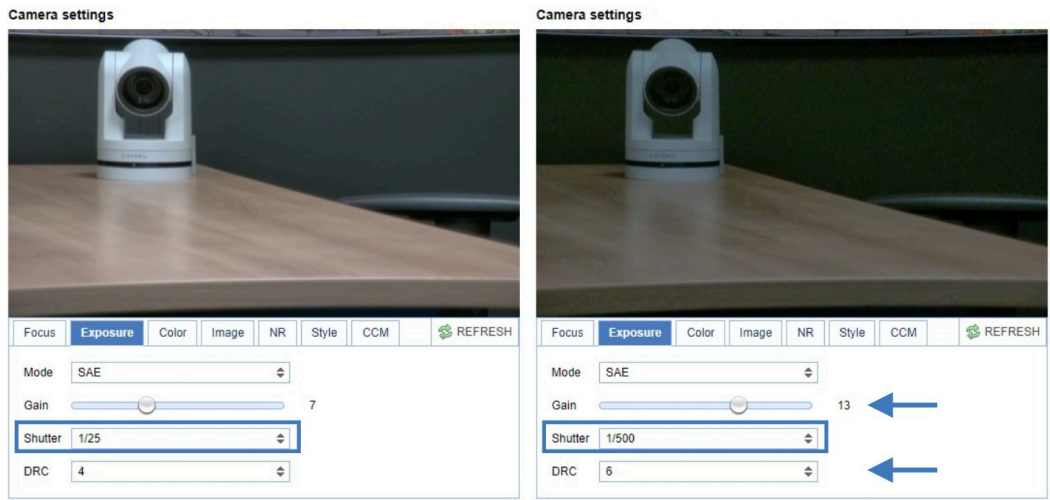

Figure 28: Exposure > Shutter speed at 1/25 (left) and 1/500 (right)

AAE Mode (Aperture Auto Exposure)

In this mode you can set the Iris F-stop value (aperture). The higher the F-stop value, the deeper the depth of field in the picture. The camera will automatically set the shutter speed based on the Iris F-stop set by the user. As the camera determines the preferable shutter speed, it is possible to turn the anti flicker setting to the required 50Hz or 60Hz to eliminate the effects of a shutter functioning at 1/50th of a second, for example. Like, with the shutter speed in SAE mode, there is a cost. The higher the F-stop value, the more dark the picture become. To compensate this you can set both the Gain Limit and the DRC.

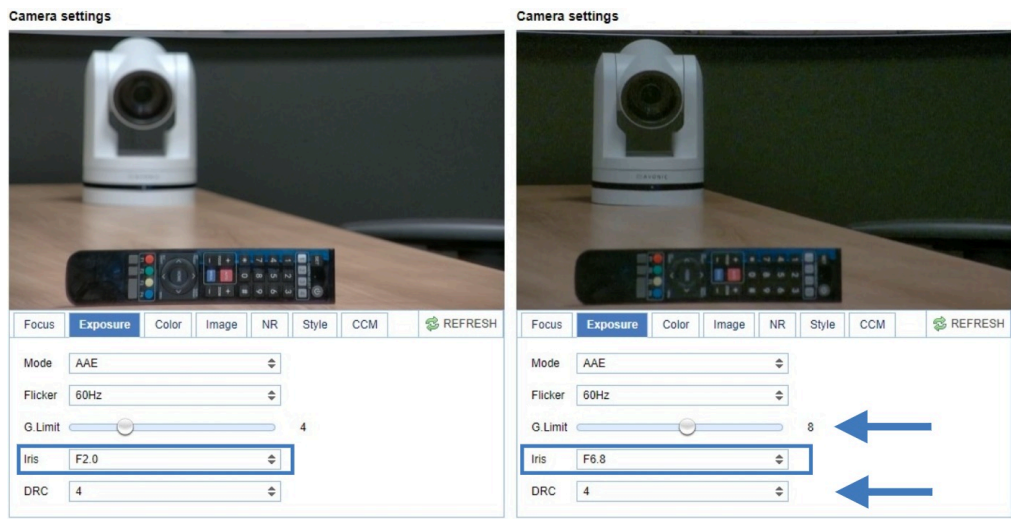

Figure 29: Exposure > AAE with Iris F1.8 (left) and Iris F6.8 (right)

Bright Mode

This mode is to try and create a decent image when the light conditions are exceptionally poor.



Figure 30: WebGUI > VIDEO > Camera Settings > Bright Exposure Mode

In this mode, you should keep the Bright level, Gain limit and DRC as low as possibly acceptable to avoid getting too much noise in the picture. If the level of noise in the image becomes unacceptable, you can use noise reduction to smooth the picture over.

Color

The color modes inside the camera are designed in such a way that the video output of the camera can match the current light conditions to produce accurate colors. There are several automatic preset modes and a manual mode to set the colors to the preference of the user.

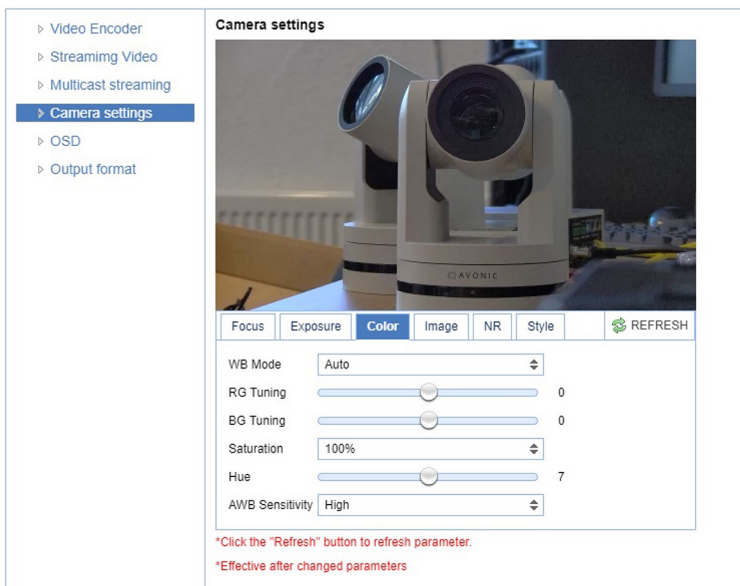
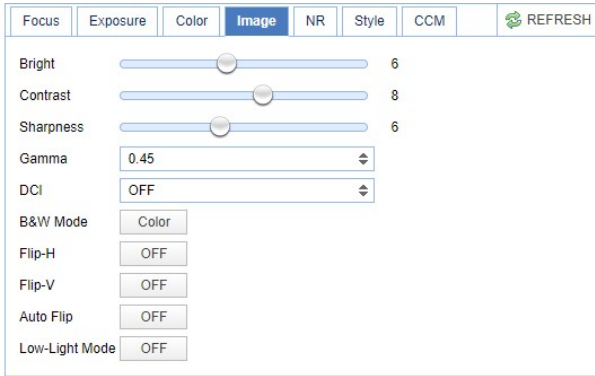

Figure 31: WebGUI > VIDEO > Camera Settings > Color

The settings are listed below.

WB mode	The camera continuously measures and defines the light conditions and acts accordingly (Auto). In this mode, there are some adjustments that can be made to tune the image to the preference of the user (in manual mode or when the white balance is set to a specific value).
RG Tuning	Red Gain Tuning, increase or decrease red.
BG Tuning	Blue Gain Tuning, increase or decrease blue.
Saturation	How saturated the image's colors are. 0% would produce a black and white image.
Hue or tint	The balance between green and red. 0 is green, 14 is red.
AWB Sensitivity	This setting indicates how quickly the camera responds to changing light settings.

Image



*Click the "Refresh" button to refresh parameter.

*Effective after changed parameters

Figure 32: WebGUI > VIDEO > Camera Settings > Image

These are settings that have an effect on the image post-processing. Basically, these settings are all artificial: they don't affect the optical parts of the camera itself. The settings are listed below.

Bright	The amount of detail that is visible in darker areas of the image. Be careful not to set this setting too high, as you will see that the image becomes 'milky-white'!
Contrast	The amount of detail that is visible in lighter areas of the image.
Sharpness	Artificial contrast, be careful no to set this too high as it will create a sort of 'halo' around sharp edges of filmed objects. The setting of sharpness coincides with the setting of noise reduction.
Gamma	The gamma curve selection has to do with the perception of the human eye to lighter and darker. If you select a higher rate of gamma, you will see that the picture become darker, but also with more detail in the picture.
DCI	The Dynamic Contrast affects the contrast of the picture. The higher the number, the more contrast you will have.
B&W Mode	Black and White Mode makes the picture black and white.
Flip-H, Flip-V, Auto flip	The Flip-H mode turns the picture horizontally, while the Flip-V mode turns it vertically by 180 degrees. When Auto Flip is on, the camera will automatically flip the picture horizontal and vertical.
Low-Light Mode	The Low-Light mode is designed for capturing video in situations where the camera is placed in an environment with very low or near-complete darkness. The frame rate will drop to 10 frames per second, to catch as much light on the sensor as possible. If this mode is required to capture a clear image, it is recommended to increase the lighting in the scene for improved results.

NR (Noise Reduction)

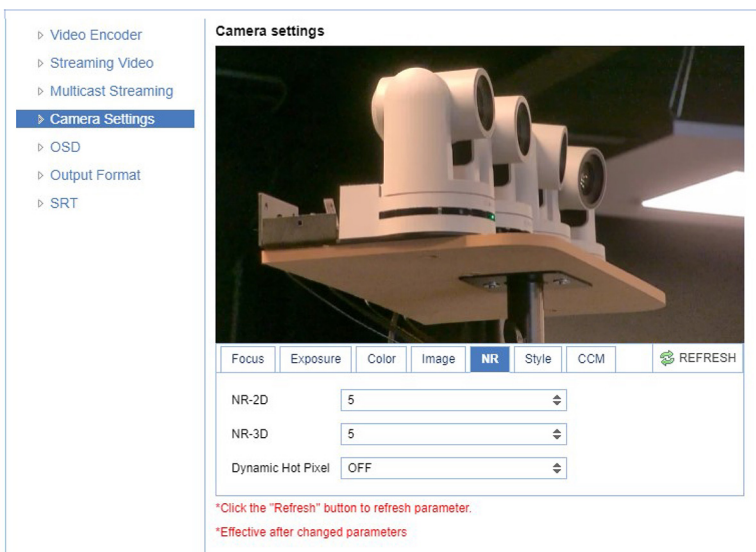

*Click the "Refresh" button to refresh parameter.

*Effective after changed parameters

Figure 33: WebGUI > VIDEO > Camera Settings > NR

Noise reduction can be used to soften the image when noise is present due to poor lighting conditions. The higher the amount of noise reduction, the softer the image will get, ultimately resulting in loss of details.

Be careful when adjusting the noise reduction, as it can take away the natural 'crispness' of the image. You will lose the natural 'crispness' of the image, if you set the dynamic contrast and gain too high (this will cause more noise). Better practice is to add light to the filmed object.

NR-2D	Used for still-standing objects.
NR-3D	Used for moving objects.
Dynamic Hot Pixel	A dynamic hot pixel is a defective pixel which look much brighter than it should and will sometimes become visible due to long exposure shots of the camera at a higher rate of light sensitivity. This is often visible as sparkles in the picture. The Dynamic Hot Pixels mode corrects the pixel so that the pixel will appear as normal on the filmed picture.

Style

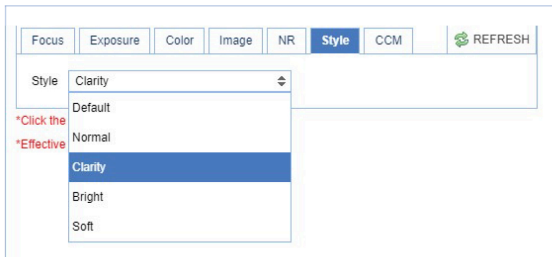

Figure 34: WebGUI > VIDEO > Camera Settings > Style

Here, you can choose the style you want, such as **Default** (standard setting), **Normal** (which makes the picture more 'natural'), **Clarity** (makes the picture more clear), **Bright** (which makes the picture more bright) and **Soft** (which softens the picture).

CCM (Customizable Color Matrix)

If you have obtained an optional license for SRT and the Customizable Color Matrix (CCM), the Camera Settings menu will include an additional tab in the camera settings: CCM. With this feature you can match the colors from the Avonic CM70 series cameras with cameras from other manufacturers. The colormatrix is a 3x3 "table" that affects red, green and blue in the filmed picture and their relation to it.



1. Open **Video > Camera Settings > CCM**
2. Click on **Enable CCM** to enable this feature. You will see the default setting with a natural picture.
3. Read the paragraphs below before you are changing these numbers!

Camera settings

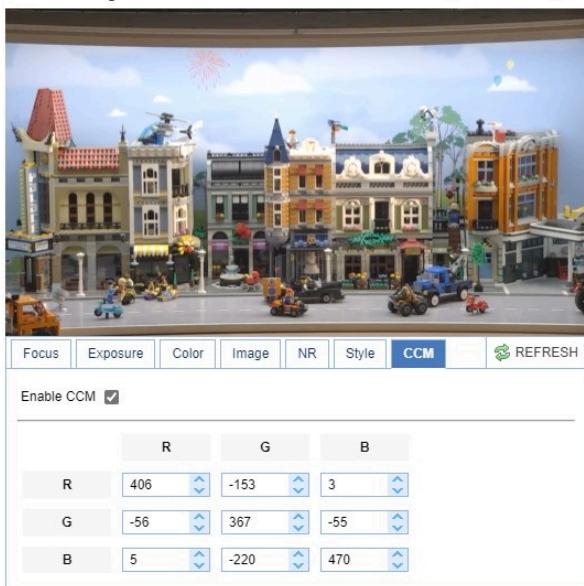

Channels and Signals

The color matrix becomes visible when the CCM feature is enabled. It has a vertical and a horizontal Red, Green, Blue (RGB) row. You can modify the colors within the image by entering numbers in the cells of the matrix.



- Channels:** Horizontal RGB row. This **corresponds** with red, green and blue parts in the picture, but changes also secondary colors, because these colors are having some red, green and blue in them.
- Signals:** Vertical RGB column. This **subtracts or adds** red, green, blue from or to the filmed picture.

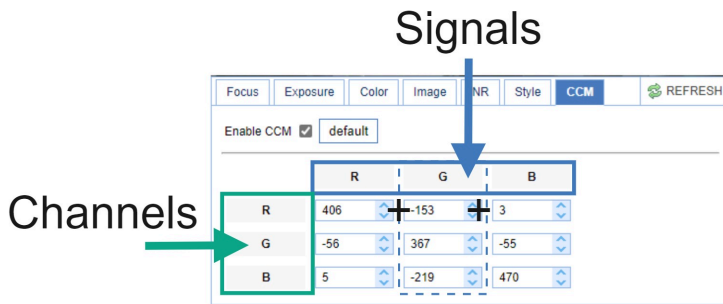

Matching and finetuning colors

Matching and finetuning colors is not so simple as it looks, because changing colors in a camera works different if you compare it with painting. It is important that you realize that the cells from the sensor (photovoltaic cells) do not carry any color information, only **luminance** information. In other words: the cells will make colors in the picture **more brighten or darker** in such a way that the balance between the colors shifts.

You need to know that the processor in the camera, for example, makes everything in the red parts red. That does not mean that everything in the red parts IS red! Even if there are a few pixels green or blue, the sensor notifies it and will make them red as well. That is why colors can look different in a camera, then when you are painting.



Best Practices:

- There is no database or any tutorial that can help to match colors between specific camera systems of different manufacturers. Every camera system works different and so the color matrix does. Changing a number in a cell, for example, in 256 in the matrix of the CM70 series camera, does not mean that this will change in exactly the same color in the picture from an another camera.
- Practice a lot to learn for yourself what the best settings are to match the colors between the CM70 series camera and a camera from an another manufacturer.
- Read the paragraphs "channels and signals," "subtracting and adding colors" to learn about the matrix.

Subtracting colors

You can subtract colors using numbers **above or below** zero in the **same cell** or in a cell of the **same row**.

- For example: If you change the number in the green channel > Red signal in a number **above zero**, it means that you are subtracting the red signal from the green channel, making green parts purple, because the camera sensor removes red into the green parts of the picture. Red and yellow parts become more green, as the red signal is decreased leaving a green tint behind. If you have a sharp eye, you can see that other colors in the picture become slightly lighter. By changing the same number in a number **below zero**, you have the same result, but other colors in the picture become slightly darker.
- If the number in the Green channel > Green Signal is changed with the same amount as in the Green channel > Red signal, green is subtracted from the picture, removing the greenish tint from the yellow and red parts. This makes the colors as they were before, but less intense and darker (because **light** is removed and not color).



Remember that:

- +256** in G-R = Red signal is **subtracted** from the green channel, changing the balance between green and red towards green. This means that red pixels in the picture will turn slightly into green and since there a lot of red pixels are in red and yellow parts, a greenish tint is "left behind" in the picture. **+256** in G-G = Green is **subtracted** from the green channel, changing the balance between red and green as it was by removing the greenish tint from the picture. Light is removed from the picture, colors become less intense and darker.
- +256** in a cell makes the picture slightly lighter, while **-256** in a cell makes the picture slightly darker.
- Subtracting** a color from the picture affects the colors from the whole picture, because there are also pixels from that color in other colors in the picture even if you cannot see them. See the pictures below:

Red and yellow parts green. left: +256, right: -256

Without the greenish tint. left: +256, right: -256

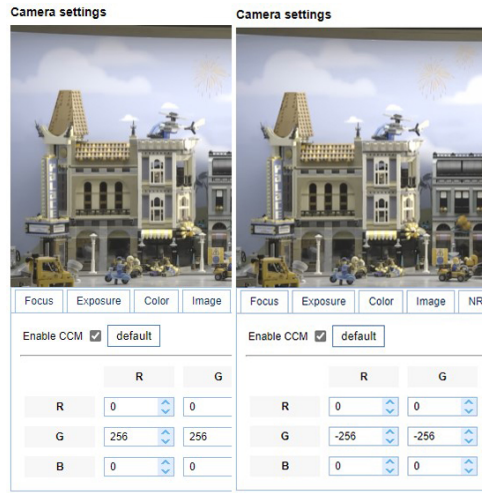
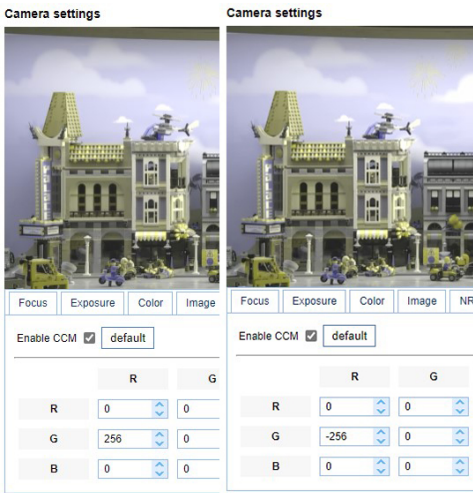

Adding colors

You can add colors by changing the balance between the red, green and blue signals. A color will be added if a number above zero is used in one cell and a number below zero is used in another cell of the same channel, or if the cells of different signals and channels are filled with a number. For example:

1. By changing the number in the Blue channel > Red signal to a number above zero and in the Blue channel > Blue signal in a number below zero, you can add blue to the picture, resulting in purple in red and yellow parts in green in blue parts.
2. By doing the opposite, changing the number in the Blue channel > Red signal to a number **below** zero and in the Blue signal > Blue channel to a number **above** zero, you can add red to the picture. However, since zero in a cell is NOT nothing, the color green will be added too in this case! This means that red parts in the picture will not become (blood) red, but orange and yellow parts become more saturated. Also the difference between the number above zero and below zero will play a role. The greater the difference between the two numbers, the more color is added and the more saturated the picture will become.



1. Adding colors is possible by using a number **above** and **below** zero in the same channel (row).
2. The bigger the difference between the numbers **above** zero and **below** zero, the more color is added to the picture and the more saturated the picture become.
3. The colors that will be shown, depends on the **balance** between red, green and blue signals.

+256 red and -256 blue

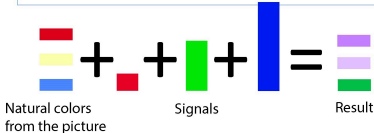
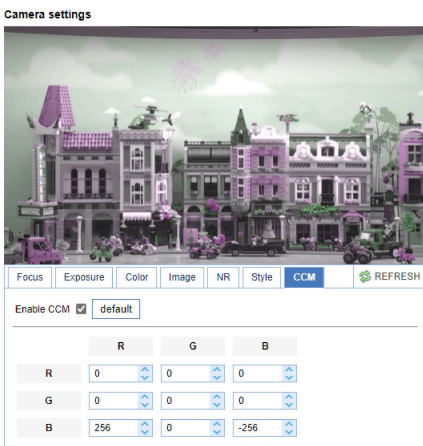

-512 red and +512 blue

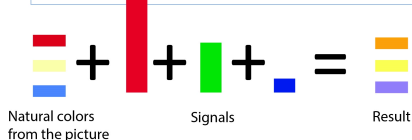
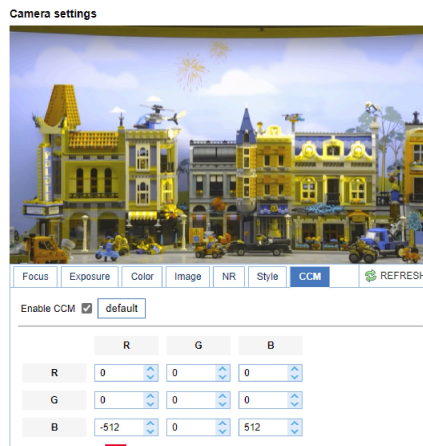

VIDEO - OSD

- Video Encoder
- Streaming Video
- Multicast streaming
- Camera settings
- OSD
- Output format

OSD



Show Time OSD Offset Title Time

Show Title

Time Font Color

Title Font Color

OSD Font Size

According to the resolution

Scale size automatically

Master Stream OSD Font Size

Slave Stream OSD Font Size

Figure 35: WebGUI > VIDEO > OSD

In this area, you can put a camera name and time as overlay on the IP stream (the overlay feature is exclusively available on the IP stream, not on other outputs).



Only the output of the camera will be shown with the main stream set to H264.

Fields

You can enable or disable **Show Time** and **Show Title** by marking or unmarking the checkbox next to the respective setting (the time and name settings can be found under the tab **SYSTEM**, sections **Attributes** and **Time**).



- Use the dropdown menus **Time Font Color** and **Title Font Color** to set the desired font colors.
- Use the directional arrows on the right to move the title and time to the preferred position on the screen.

OSD Font Size (related to Camera Name and Time)

You can use **Scale size automatically** for both main stream and sub stream. If checked, the camera name and time overlay will always scale with the image, keeping the proportions intact.



Click **SAVE** to apply your settings. A small confirmation dialogue appears in the bottom right corner.

VIDEO - Output Format

Figure 36: WebGUI > VIDEO > Output Format

This setting is related to the output resolution and frame rate on the HDMI and SDI connectors.

The WebGUI can be used to set the resolution of the main and sub IP streams. The resolution of the USB output is determined by the computer that is connected to it.



Click **SAVE** (not shown here) to apply your settings. A small confirmation dialogue appears in the bottom right corner.



Video output over IP cannot be a higher resolution than the physical SDI/HDMI output setting.

VIDEO - SRT

These settings are related to SRT streaming protocol. SRT is **only** available when you purchase our [optional license](#). With SRT you can define the port, passkey and encryption bit.



When not using Encryption, please make sure to set the **Crypto key length** to 0.

SRT Listener Mode and Caller Mode are both supported. You can define the Listener mode settings here, whereas the Caller Mode settings can be defined in the [Streaming Video](#) tab.

See the respective figures below for the Listener and Caller Mode Settings.

Figure 37: WebGUI > VIDEO > SRT (Listener Mode)

Stream	Main Stream	Sub Stream
Enable	<input type="checkbox"/>	<input type="checkbox"/>
Protocol Type	SRT	SRT
Host Address	192.168.5.11	192.168.5.11
Host Port	1935	1935
Stream Name	live/av0	live/av1
User Name		
Password		
Password for stream encryption		
Crypto key length in bytes	0	0

Figure 38: WebGUI > VIDEO > Streaming Video (Caller Mode)

NETWORK



Use the tabs on the NETWORK screen to define the appropriate **Port**, **Ethernet** and **DNS** settings.

Port Settings

Port Settings	Port Settings
Port Data	3000
Port Web	80
Port Onvif	2000
Port Soap	1936
Port RTMP	1935
Port Rtsp	554
Port Visca	1259
Port WebSocket	8088

Figure 39: WebGUI > NETWORK > Port Settings

You can define specific ports for the different streaming outputs and protocols the camera supports.



Make sure these settings don't interfere with other uses and services on the same network.



Click **SAVE** to apply your settings. A small confirmation dialogue appears in the bottom right corner.

NETWORK - Ethernet

In this section, you can specify the IP settings for the Ethernet adapter.

Ethernet	Ethernet
DHCP	<input type="checkbox"/>
IP Address	192.168.5.163
Subnet Mask	255.255.255.0
Default Gateway	192.168.178.1
MAC Address	98:14:D2:21:12:F0

Figure 40: WebGUI > NETWORK > Ethernet



Execute the following steps to save your settings:

1. Click **SAVE** to apply your settings. A small confirmation dialogue appears in the bottom right corner.
2. Reboot the camera.

NETWORK - DNS

Here, you can specify the **Preferred** and **Alternative DNS Server**.

Figure 41: WebGUI > NETWORK > DNS



Click **SAVE** to apply your settings. A small confirmation dialogue appears in the bottom right corner.

SYSTEM

You can use the **SYSTEM** tabs (described below) to define the desired system settings.

License

Figure 42: WebGUI > SYSTEM > License

If you have obtained the license for the premium features of this camera, you can enter the License key here to unlock these features. **Reboot is not required as the license is instantly activated.** See for more information [How to register a license in a CM70 series](#).



You can acquire a [license](#) through your local sales channel or directly at Avonic.



Execute the following steps to enter your license key:

1. Enter your license key in the **license** field.
2. Click **SAVE** to apply your settings. A small confirmation dialogue appears in the bottom right corner.
3. Refresh your webpage or log out and in again.

Attributes

Figure 43: WebGUI > SYSTEM > Attributes

Specifying a specific device name to be displayed in the OSD can be useful when using multiple cameras on the same LAN. The Device-ID is always 1 (addressing is done via IP). The language cannot be changed.



The ONVIF protocol does NOT accept spaces in the camera name.



Click **SAVE** to apply your settings. A small confirmation dialogue appears in the bottom right corner.

Time

Figure 44: WebGUI > SYSTEM > Time

You can **manually** set the time and date, or synchronize the time and date via a computer or an external server on the LAN or WAN.



Either click **SAVE** to apply your manual settings, or **SYNC** to synchronize the time and date.

User

Figure 45: WebGUI > SYSTEM > User

You can define different users with specific permission levels and different username / passwords combinations. There are 2 levels of users: **administrators** with access to all features, and **user-1 and user-2** with access to the preview and PTZ controls. Click **SAVE** to apply your settings.

It is also possible to fill in automatically your user name and password using your browser if you use password managers as LastPass for example.

The last option you have, is the (HTTP) Basic Authentication. Basic Authentication is a popular way to prove your identity when using websites. You provide your username and password, and the server checks if they are correct. If they match, access will be granted. If they don't match, you'll see a specific message. Remember, use always strong passwords and user names.



Use this in the following way:

1. Click Enable and SAVE.
2. In the lower right corner appears a notification to reboot the camera. Reboot the camera.
3. After the reboot is completed open the WebGUI again and you will see that your browser ask you for your username and password instead of the normal login.
4. Disable the Basic Authentication, click SAVE and reboot the camera again to return the normal login page of the WebGUI.

Update

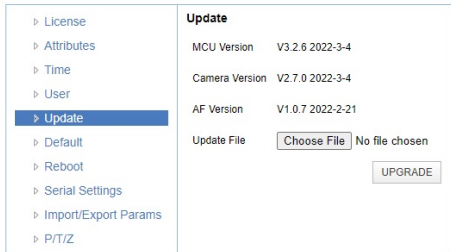

Figure 46: WebGUI > SYSTEM > Update

By default, this screen shows a readout of the current firmware versions. The **Update file** provides a firmware upgrade functionality via this screen. When the camera is done uploading and processing the update, it will automatically reboot. See [How to update a CM40 or CM70 series camera](#) on the website for more information.



Follow instructions below carefully and read the "How to" article above. If you experience issues during the update, follow [Troubleshooting > WebGUI > Firmware update failed](#).



Execute the following steps to perform a firmware upgrade.

1. Click **Choose File** to select the firmware update file.
2. Click **UPGRADE** to start the firmware upgrade wizard.
3. Follow the steps in the wizard and wait until the process finishes and reboots.
4. Refresh your browser and log in again after the reboot.

Default

If necessary, you can perform a factory reset. This restores all default settings. See also [How can I reset my CM40/ CM70 camera from the WebGUI?](#) for more information. If you want only to reset the IP configuration (IP address, Gateway and DNS server) read [How to reset the IP Configuration in a CM40/ CM70 camera](#).

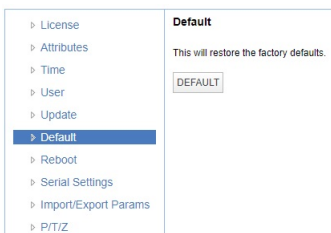

Figure 47: WebGUI > SYSTEM > Default



Click on the button **This will restore the factory defaults** to perform a factory reset. When completed, the camera automatically reboots. The camera will be ready for use again after the boot cycle.

Reboot

If necessary, you can manually perform a camera reboot. It is also possible to create a new reboot schedule to automatically reboot the camera at any time you want.

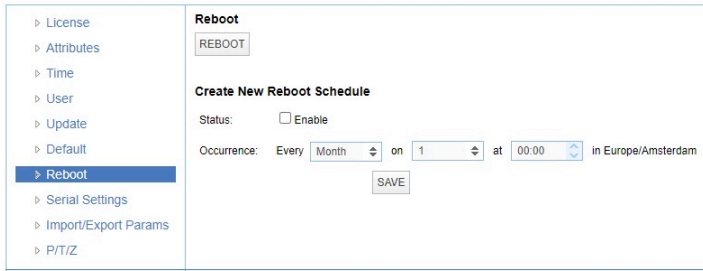

Figure 48: WebGUI > SYSTEM > Reboot



Click on the button **Reboot** to reboot the camera. It will be ready for use again after the boot cycle.



Follow instructions below if you want to create a new reboot schedule.

1. Enable "create new reboot: status".
2. Select at "occurrence" the month and day and select the time you want to reboot the camera. Take note that the **Amsterdam/ European timezone** is used.

Serial Settings

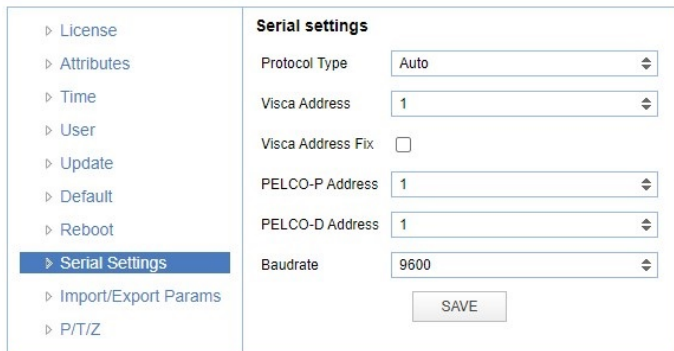

Figure 49: WebGUI > SYSTEM > Serial Settings

You can choose the preferred protocol to use and the accompanying address to go with it. Or you can select the default protocol type 'Auto' to let the camera detect which protocol is being used. **Addressing** is still needed, even with the automatic setting.



Click **SAVE** to apply your settings. A small confirmation dialogue appears in the bottom right corner.

Import/Export Parameters



Figure 50: WebGUI > SYSTEM > Import/Export

The CM70 series cameras have the ability to import or export a configuration.



Execute the following steps to import or export your configuration parameters:

1. Select the appropriate button to import or export your configuration parameters.
2. Follow the steps in the wizard that appears.



The exported settings do NOT include any presets that are stored in the camera!

P/T/Z

<ul style="list-style-type: none"> ▶ License ▶ Attributes ▶ Time ▶ User ▶ Update ▶ Default ▶ Reboot ▶ Serial Settings ▶ Import/Export Params <li style="background-color: #0070C0; color: white;">▶ P/T/Z 	<p>P/T/Z</p> <p>PTZ Speed <input checked="" type="radio"/> Slow <input type="radio"/> High</p> <p>Speed by zoom <input checked="" type="checkbox"/></p> <p>Image Freezing <input type="checkbox"/></p> <p>Low Power Mode <input checked="" type="checkbox"/></p> <p>Enable/Disable Infrared Receiver <input checked="" type="checkbox"/></p> <p>Zoom Speed <input type="text" value="8"/></p> <p>Preset Pan Speed <input type="text" value="25"/></p> <p>Preset Tilt Speed <input type="text" value="21"/></p> <p>Preset Zoom Speed <input type="text" value="8"/></p> <p style="text-align: center;"><input type="button" value="SAVE"/></p>
---	--

Figure 51: WebGUI > SYSTEM > P/T/Z

In this window, you can define various P/T/Z settings for your camera. These are:

PTZ Speed	This increases the maximum pan and tilt speed. This can be useful in a conference system where quick action is necessary. In "slow" mode the panning speed will be 100° per/sec and the tilting speed will be 35° per/sec, while in "high" mode this is 120° per/sec (panning speed) and 70° per/sec (tilting speed). The higher speed in "high" mode increases the sound production that is coming from the camera.
Speed by zoom	This mode affects PTZ speed when the camera is zoomed in to its max. If you move the stick of your controller when this mode is disabled, it will move too fast to control it. Enabling reduces this speed in relation to the current zoom factor.
Image Freezing *	You can freeze the image when the camera moves from one preset to another when you use your (remote) controller.
Low Power Mode:	The camera will go in stand by mode to reduce its power when this mode is enabled. In order to reduce the power, the camera will shut down the IP Port. To activate the camera again, use a serial connection or the IR Remote to set off the Low Power Mode.
Enable/ Disable Infrared Receiver:	It is possible to enable/disable the Infrared Receiver. When you disable the Infrared Receiver and the Low Power Mode is enabled, it will NOT be possible to activate the camera again using the IR Remote Control.
Zoom Speed	You can set the speed to which the camera will zoom in to the image. The higher the number, the faster the camera will zoom in. This works only when the remote controller is used to control the camera.
Preset Pan, Tilt and Zoom Speed	This mode affects the speed to which the camera is switching from one preset to another when you use your (remote) controller. The higher the number, the faster it will switch.



* If you are using audio during streaming, put it first **OFF** before freezing the image! Freezing the image could produce a paused audio output on the IP Stream. This leads to (audio) stuttering. The video stutters when it is re-engaged, but this is rather easily solvable by putting the iFrame value at 4 or 5 times per second. That is quick enough to counteract the video stutter.

MJPEG Snapshot

The Avonic CM70 series cameras are equipped with a MJPEG snapshot feature to, for example, implement into third party software. Every time the page is refreshed, the picture will be updated.



To access the MJPEG snapshot feature, use the following format: <http://IP/img/capjpg/snapshot.jpg>. See also [MJPEG Snapshot](#) on the website.

Using the Remote Control

The Product is provided with an IR Remote Control for full control of the camera and use of the OSD menu.



Figure 52: Remote Control

The various options (a. through n.) are outlined below.

a. Power



1. Put two AAA 1.5v batteries in the IR Remote Control. Use **ONLY** this type of batteries! Using other type of batteries can damage the IR Remote Control.
2. Press the **Power** button to turn on the camera. If the position preset '0' has been stored, this will be called after initialization.
3. Press the **Power** button again to turn the camera off. It will turn backwards when turned off, this is called the "privacy mode".

b. Set

This button has **no** function with this camera.

c. Camera Select

Up to 4 different cameras can be controlled with one IR remote Control. You can use the **camera select** buttons [1,2,3,4] to select the IR channel that is used by the remote control. The default camera IR channel is 1.



1. To control a camera on first use, select camera 1 (IR channel 1) on the remote control.
2. To control a second camera, you must first adjust the IR channel in the camera settings from 1 to 2. Do the following:
 - a. Deactivate the cameras in the room that are not intended to be modified (except for camera 1).
 - b. Select camera 1 on the remote control, because the camera is still configured to listen to IR channel 1.
 - c. Press [*]→[#]→[F2] to change the IR channel inside the camera to IR channel 2. The camera will confirm this on the screen.
 - d. Select camera 2 on the remote control to control this camera.

Key Combinations: (Default IR address is 1)

[*]→[#]→[F1]	Camera Address No. 1
[*]→[#]→[F2]	Camera Address No. 2
[*]→[#]→[F3]	Camera Address No. 3
[*]→[#]→[F4]	Camera Address No. 4



The Function buttons F1, F2, F3 and F4 are the colored buttons on the remote.

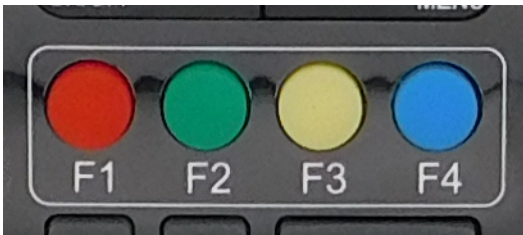

Figure 53: Function Buttons on Remote

d. Number Keys

The number keys are used to call presets.



Press the number [0-9] of the desired preset and the camera will respond accordingly (See 'h' on how to set & clear presets).

e. Focus + -



1. Push the button [manual focus] first before using the focus buttons.
2. Focus the camera with the [+] and [-] button.

If the camera does not respond, check if the camera is set to auto-focus.

f. Auto/Manual Focus



Set the camera to 'auto focus' or 'manual focus'.

If the camera is configured to 'auto focus', the buttons [Focus + -] are disabled.

If the camera is in 'manual focus' and the **Zoom** buttons are used, the camera automatically switches to 'auto focus'.

g. Zoom + -



Zoom the camera with these buttons.

h. Set & Clear Preset

A preset is a specific position of a camera that you can save in the camera. A preset is assigned to a number from 0-9.



1. To set a preset, first point the camera in a specific direction and a specific zoom position.
2. Assign the position to a number with the button **Set Preset**.
3. Call the preset by pressing one of the numbers 0-9 on the remote control.

Set Preset: [SET PRESET]→[<number>]

Call Preset: [<number>]

Clear Preset: [CLEAR PRESET]→[<number>]

If the position preset '0' has been stored, this position will be called after initialization.



Use ONLY presets between 0-9 when using the Remote Control. For presets 10 or higher you need a serial or IP connection.

i. PTZ Keys (up/down/left/right)



Use these keys to move the camera in the desired direction.

j. Home



Use this key to turn automatically the camera to its start up position. The camera will zoom out and turns to a position with the lens straight forward. This affects only the Pan, Tilt and Zoom position and NOT the focus level of the camera, or exposure and white balance settings.

k. BLC ON/OFF



Use this key to enable / disable the Back Light Compensation feature.

l. Menu



1. Use the **Menu** button to open the **On Screen Display (OSD)** menu. This menu is visible on the HDMI/SDI output.
2. If the menu is not in English, press **[*]→[#]→[4]** to change the Menu language into English.

m. Function Keys (F1/F2/F3/F4)

Used to configure the IR channel of the camera. See '**c. Camera Select**' above for instructions.

n. Blank Buttons

These buttons have NO function with this camera.

Other Key Combinations

The following key combinations on the Remote Control have specific functions. These are:

Combination	Function
[*] → [#] → [4]	Menu set to English
[*] → [#] → [6]	Restore factory defaults
[*] → [#] → [9]	Flip switch (just temporary flip to view the image flipped)
[*] → [#] → [Auto]	Enter into the aging mode, only for quality control purposes
[*] → [#] → [Manual]	Restore the default username, password, and IP address
[#] → [#] → [#]	Clear all presets
[#] → [#] → [0]	Switch the video format to 1080p60*
[#] → [#] → [1]	Switch the video format to 1080p50*
[#] → [#] → [2]	Switch the video format to 1080i60*
[#] → [#] → [3]	Switch the video format to 1080i50*
[#] → [#] → [4]	Switch the video format to 720p60*
[#] → [#] → [5]	Switch the video format to 720p50*
[#] → [#] → [6]	Switch the video format to 1080p30*
[#] → [#] → [7]	Switch the video format to 1080p25*
[#] → [#] → [8]	Switch the video format to 720p30*
[#] → [#] → [9]	Switch the video format to 720p25*



The camera returns to the video output setting of the system select after a reboot.



Use ONLY presets between 0-9 when using the Remote Control. For presets 10 or higher you need a serial or IP connection.

Tally Light Functionality

If you have acquired the [optional license \(LC70-1\)](#), you gain the ability to control the tally light of the camera. Without this the LED on the front of the camera cannot be managed. The tally light can only be controlled using VISCA commands and cannot be configured through the camera's WebGUI or OSD menu. See for the commands [How to control a tally light on the CM70 series camera?](#) or the [VISCA commands](#) in appendix A in this manual.



OSD Menu

Each camera is provided with an **On-Screen Display (OSD) Menu**.

This is an integrated on-screen menu that can be accessed within the camera to change specific functions that affect how the camera processes an image.

The OSD Menu is visible on the HDMI and SDI outputs.

The OSD menu can be accessed by the Remote Control or an Avonic PTZ controller. See also [How can I open the OSD menu of my camera on the website](#).

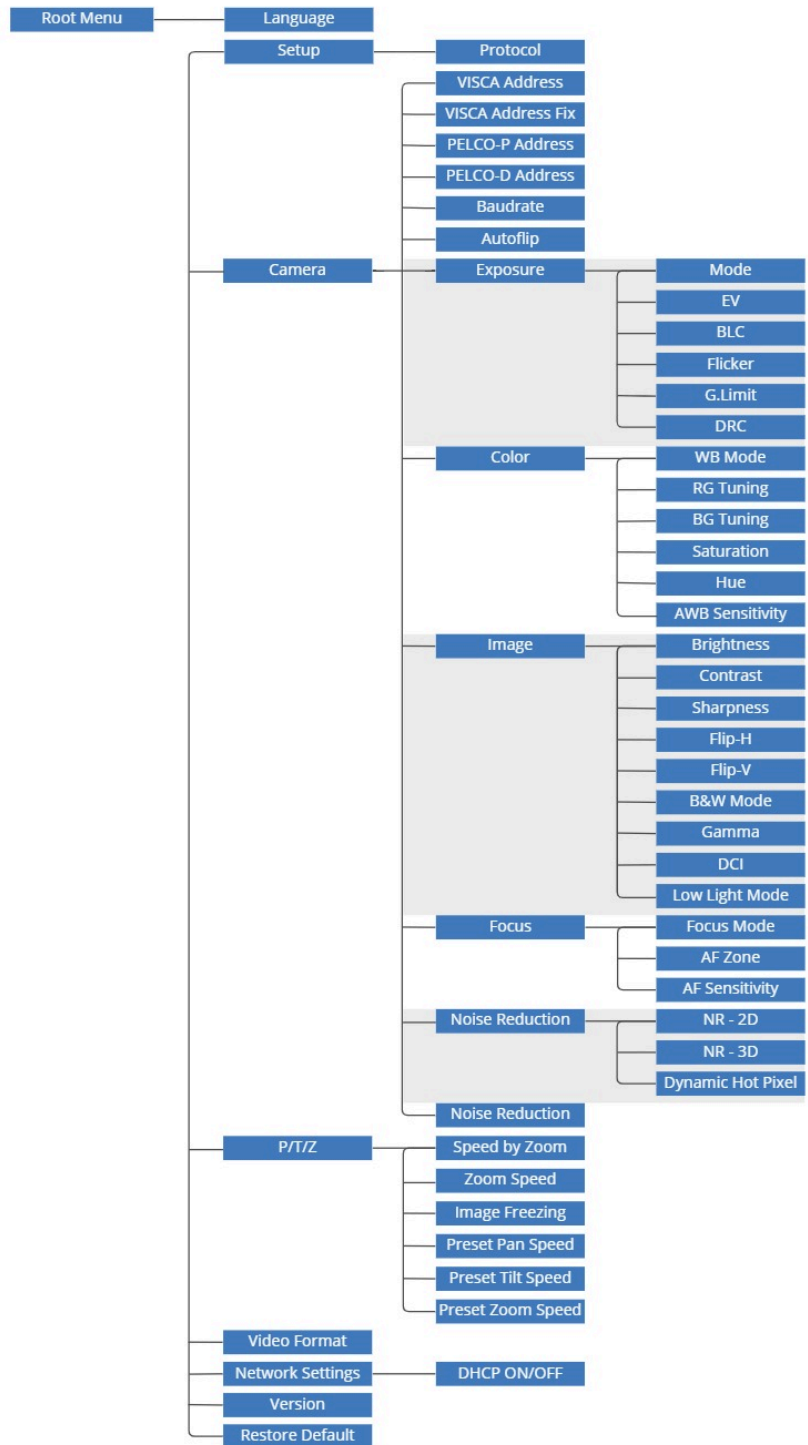

Figure 54: OSD menu structure

1. MENU

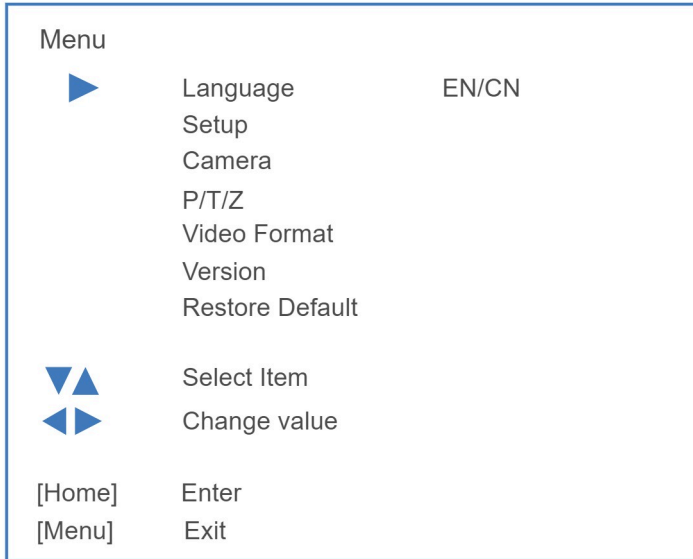

Figure 55: OSD - MENU



1. Press the **MENU** button to display the main menu on the screen.
2. Use the arrow buttons to move the cursor to the item to be set. Press the **HOME** button to enter the corresponding sub-menu.
3. Press [**◀▶**] to change settings. Press [**MENU**] again to go back.

2. SETUP



Figure 56: OSD - SETUP

3. CAMERA

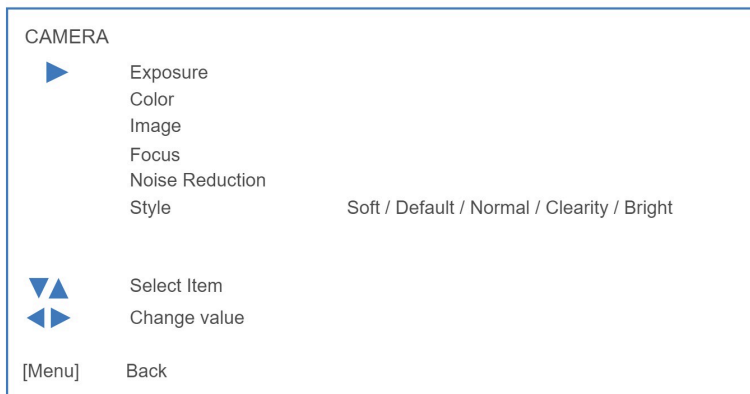

Figure 57: OSD - CAMERA

3.1 EXPOSURE

EXPOSURE		
▶	Mode	Auto / Manual / SAE / AAE / Bright
	Iris	F11 ~ F1.8 / Close
	Shutter	1/25 ~ 1/10000
	EV	ON / OFF
	EV Level	-7 ~ +7
	BLC	ON / OFF
	Flicker	50Hz / 60Hz / OFF
	G.Limit	0 ~ 15
	DRC	1 ~ 8 / CLOSE
⬇️⬆️	Select Item	
⬅️⬆️	Change value	
[Menu]	Back	

Figure 58: OSD - EXPOSURE

3.2 COLOR

COLOR		
▶	WB Mode	Auto / 2400 ~ 7100 100k increments / Manual / One Push
	RG Tuning	-10 ~ 10
	BG Tuning	-10 ~ 10
	RG	0 ~ 255
	BG	0 ~ 255
	Saturation	60% ~ 200%
	Hue	0 ~ 14
	AWB Sensitivity	Low / Middle / High
⬇️⬆️	Select Item	
⬅️⬆️	Change value	
[Menu]	Back	

Figure 59: OSD - COLOR

3.3 IMAGE

The Flip function can be set, although the camera has an automatic flip function.

IMAGE		
▶	Brightness	0 ~ 14
	Contrast	0 ~ 14
	Sharpness	0 ~ 15
	Flip-H	ON / OFF
	Flip-V	ON / OFF
	B&W Mode	Color / B&W
	Gamma	0.45 / 0.50 / 0.55 / 0.63 / Default
	DCI	1 ~ 8 / Close
	Low Light Mode	ON / OFF
⬇️⬆️	Select Item	
⬅️⬆️	Change value	
[Menu]	Back	

Figure 60: OSD - IMAGE

3.4 FOCUS

FOCUS		
▶	Focus Mode	Auto / Manual / OnePush
	AF-Zone	Front Focus / Back Focus / Meeting / Education Tracking / Moving Objects / Center Focus
	AF-Sensitivity	Low / Middle / High
▼▲	Select Item	
◀▶	Change value	
[Menu]	Back	

Figure 61: OSD - FOCUS

3.5 NOISE REDUCTION

NOISE REDUCTION		
▶	NR-2D	1 ~ 7 / Auto / OFF
	NR-3D	1 ~ 8 / Auto / OFF
	Dynamic Hot Pixel	1 ~ 5 / OFF
▼▲	Select Item	
◀▶	Change value	
[Menu]	Back	

Figure 62: OSD - NOISE REDUCTION

3.6 STYLE

STYLE		
▶	Style	Default / Normal / Clarity / Bright / Soft
▼▲	Select Item	
◀▶	Change value	
[Menu]	Back	

Figure 63: OSD - STYLE

4. PTZ

PTZ		
▶	Speed by Zoom	ON / OFF
	Zoom Speed	1 ~ 8
	Image Freezing	ON / OFF
	Preset Pan Speed	1 ~ 25
	Preset Tilt Speed	1 ~ 21
	Preset Zoom Speed	1 ~ 8
▼▲	Select Item	
◀▶	Change value	
[Menu]	Back	

Figure 64: OSD - PTZ

5. VIDEO FORMAT

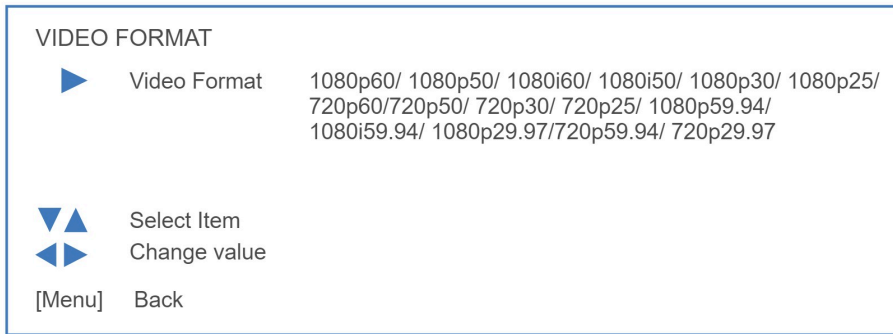

Figure 65: OSD - VIDEO FORMAT

6. NETWORK SETTINGS

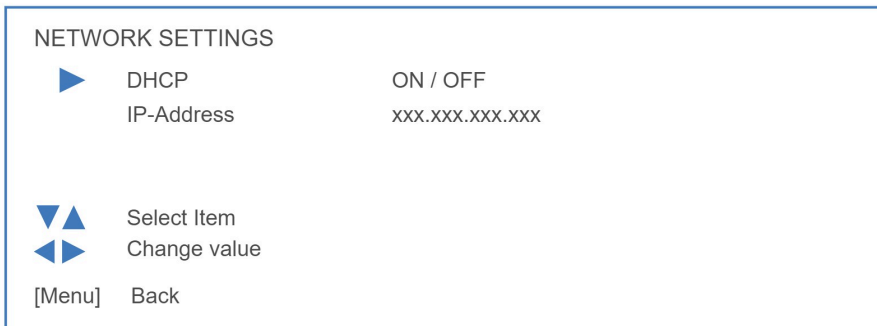

Figure 66: OSD - NETWORK SETTINGS

Read for more [CM40 & CM70 series network setup guide](#) on the website.

7. VERSION

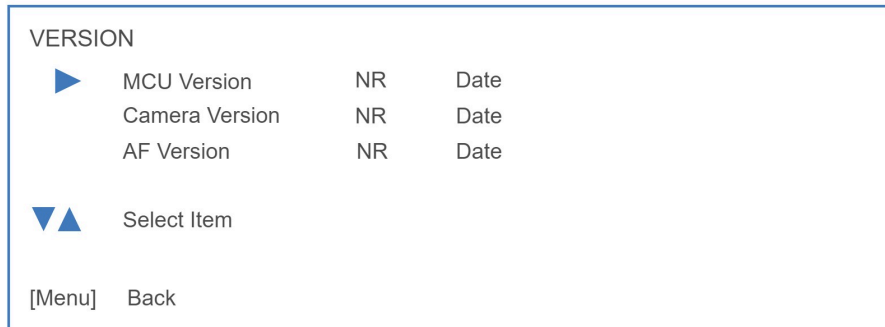

Figure 67: OSD - VERSION

8. RESTORE DEFAULT

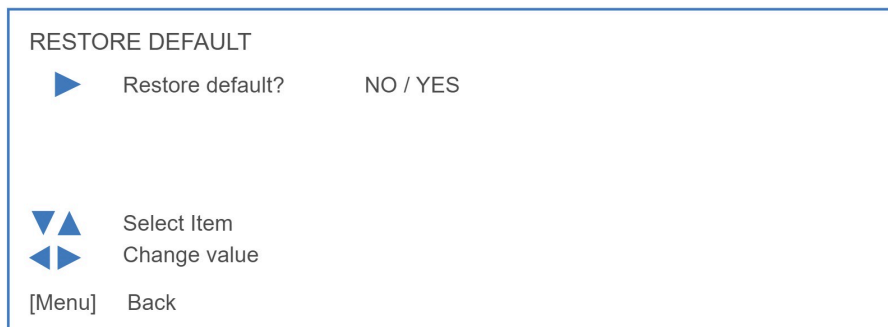



Figure 68: OSD - RESTORE DEFAULT

Using the System Select

The rear of the Product is provided with a System Select that can be used to manually select a video format. This System Select is important for the video quality during video recording or streaming.

See the table below for a description of the possible settings and the associated video output quality.



0	1080p60	8	720p30
1	1080p50	9	720p25
2	1080i60	A	1080p59.94
3	1080i50	B	1080i59.94
4	720p60	C	720p59.94
5	720p50	D	1080p29.97
6	1080p30	E	720p29.97
7	1080p25	F	Default (via OSD)

Figure 69: System Select

A few notes on the System Select:

- The setting 'F' is the **default** setting. If you set the system select to 'F', you can set the video format via the [OSD Menu](#). If you change the system select to another setting than F, it is not possible to change it again using the OSD menu. Change it back (manually) to use the OSD video format setting.
- The **highest** video output quality 1080p60 (setting '0').
- The **lowest** video output quality is 720p25 (setting '7').



It is recommended to set up the video output through the WebGUI or the OSD Menu, because this is much easier, than selecting the [video output](#) manually. If this is not possible, you can use the System Select.



IMPORTANT

- After changing the System Select, you need to restart the camera to take effect.
- 720p30, 720p29.97 and 720p25 are not supported by the SDI output.
- There are five ways to select the video output of the camera (OSD / direct button combination on the remote control / WebGUI / System Select/ HTTP API >"VideoOUT"command). The System Select takes priority after a reboot, except on setting F, where all the outputs are defined digitally.
- If you have made a change to the System Select, a "hard reboot" is needed. Click the Reboot button and when the reboot is finished, set the camera off and unplug all cables connected to the camera. Replug them again and start the camera.

MAINTENANCE

Camera Maintenance



Take the following actions to maintain the camera:

- Turn the power switch off and disconnect the AC powercord of the AC adaptor to the outlet, if you will not use the camera for a long time.
- Use a soft cloth or tissue to clean the camera cover.
- Use a soft dry cloth to clean the lens. If the camera is very dirty, clean it with diluted neutral detergent.



Do not use any type of solvents, which may damage the surface.

Usage Precautions



Take the following precautions to ensure good image quality:

- Do not film extreme bright objects for a prolonged period of time, such as sunlight, light sources, etc.
- Do not operate in unstable lighting conditions, otherwise the produced image could be less than optimal.
- Do not operate close to powerful electromagnetic radiation, such as TV or radio transmitters, etc.

TRANSPORT AND STORAGE

Specific guidelines apply for transportation and storage of the camera. Follow the guidelines below:



Transport:

1. The camera needs protection against vibration and shock. Ensure that the camera cannot move inside its box and inside the transportation vehicle. Ensure also that the box is properly sealed.
2. Avonic's address and/or the address of the local distributor should be clearly visible on the package.
3. Keep the transportation vehicle dry and maintain the temperature and humidity when transporting the camera. See '**Operating humidity**' and '**Storage temperature**' in the provided **Datasheet** for the applicable values.



Storage:

1. Maintain adequate ventilation in your storage room and ensure that any (other) materials does not obstruct the ventilation.
2. Do NOT store the camera in a storage room together with (highly) flammable materials or where the air contains such chemicals.
3. Ensure that the camera has protection against vibration and shock inside the storage room and cannot move or fall of.
4. Keep the storage room dry and maintain the temperate and humidity when storing the camera. See '**Operating humidity**' and '**Storage temperature**' in the provided **Datasheet** for the applicable values.

DISPOSAL AND RECYCLING

In general, the term 'E-Waste' or 'Waste of Electrical and Electronic Equipment' applies to items of all types of electrical and electronic equipment and its parts that have been discarded by the owner as waste without the intention of re-use.



E-Waste, like the camera and **ALL** of its accessories, needs to be disposed **separately** from normal waste! See the symbol below that can be found on the product and package label:



Avonic is NOT responsible for personal data left in the settings of the camera as far as this is possible (like camera names, IP Addresses, user names, passwords etc.) **Delete** personal data **BEFORE** you send the camera back to your local distributor or Avonic!



Send the camera and all its accessories to [Avonic](#) or your **local distributor**. See [Package Contents](#) to see what you have to send back. Follow the instructions from the [Return Procedure](#) and [Transport and Storage](#).

Avonic outsources the disposal and recycling of its E-Waste camera materials to **Stichting Open**.



See <https://stichting-open.org/> for more information about the disposal and recycling.

TROUBLESHOOTING

General

-  1. Turn the camera off and on again and check if the problem persists.
- 2. If it does, restore to factory default.

Power Issues

-  If the camera does NOT perform a self-test and / or if the power LED is OFF:
 1. Check the net power.
 2. Check the power supply.
 3. Check the physical power button on the back of the camera.

Image

No image

- 
 1. Check the power of the camera and monitor.
 2. Check the quality and length of the video cable.
 3. Check if the video specifications of your monitor matches the specifications of the camera.
 4. Check if the Iris under **Exposure settings** is set to 'closed'.

Abnormal image

- 
 1. Check the quality and length of the video cable.
 2. Check the cable connections.
 3. Check if the Iris under **Exposure settings** is set to 'closed'.

Dithering or flickering image



- 
 1. Check the camera fixation and nearby vibration sources.
 2. Check the [Anti-flickering](#) setting in the OSD.
 3. Check the [Noise Reduction](#) settings in the OSD.

Color issues

-  Check the OSD settings for [exposure](#), white balance, color temp, Red and Bluetuning.

 When experiencing image problems, you may also check [Appendix D - CMOS Image Sensor Characteristics](#)

Autofocus Issues

- 
 - Check the [autofocus](#) (position, speed etc.) before streaming
 - Check [Video/Camera Settings](#) in de WebGUI or the OSD menu (for example: if the image is too bright, too dark, or too noisy, the camera will have difficulties to focus)
-  Check environmental conditions and the subject of focussing. The camera will have difficulties to focus in the following situations:
 - Light: Strong light, low light/dark areas and backlight conditions
 - Moving subjects
 - Small objects before a plain or solid background
 - Blurry or unsharp subjects: filming through wet glass or dirty objects

- Distance: filming two or more different subjects, some near and some far away
- Position in the image: subject positioned in the corners of the picture
- Faces: partly hidden faces, sideways filmed faces, diagonal or up side down
- When the camera itself moves, or when the iris is narrowed down



When you experience one or more of the above mentioned problems check also our [Appendix - CMOS characteristics](#)

Control

No self-test (PTZ cameras only) and no power LED



1. Check the net power
2. Check the power supply

Remote Controller does not work



1. Check the power of the controller.
2. Check the RS-232 or RS-485 cable quality, length, polarity and network architecture.
3. Check the serial communication settings on the camera and controller.
4. Check the VISCA / PELCO address settings on the camera and controller.
5. Check the IP network settings on the camera and controller.

Camera does not respond to commands send over IP



1. Check if the [Low Power Mode](#) is set to ON. If so disable it.

WebGUI

Cannot enter WebGUI



1. Check the network cable.
2. Check if the computer is connected to the same subnet as the camera.
3. Use an **incognito** window in your browser, sometimes cache issues arise when using multiple cameras that have the same default IP address
4. Reset the factory default IP settings by pressing [*] [#] **[Manual]** and **Reboot**.

Firmware update failed



1. Check firmware file integrity, download it again.
2. Make sure you are trying to flash the UVC file for the correct color camera (ARM is generic, UVC is color-dependent).

APPENDIX A - VISCA SETTINGS AND COMMAND LIST

VISCA is a professional camera control protocol used with PTZ cameras. It works by sending commands to the camera either over a serial or over an IP connection, in return the camera sends ACK acknowledgment and COM completion answers to let the sender know the commands have been received and completed. The [list](#) below describes the commands, ranges and camera answers.

The VISCA Settings and Command list is available as an appendix in this manual and as an separate document that you can download on the [product website](#).

VISCA over Serial Connection

VISCA is based on RS232 Serial communications at 9600 bit/s, 8N1, no flow control. VISCA uses a serial repeater network configuration to communicate between the controller (device #0) and up to 7 peripherals (#1 through #7). The daisy chain cable configuration means that a message walks the chain until it reaches the target device identified in the data packet. Responses then walk the rest of the way down the chain and back up again to reach the sender. Some packets are broadcast to all devices.

A command data packet consists of:

- Address byte (1) message header
- Information bytes (1..14)
- Terminating byte (1) 0xFF



You can use **Hercules SETUP Utility** application and a serial connection to make this work.

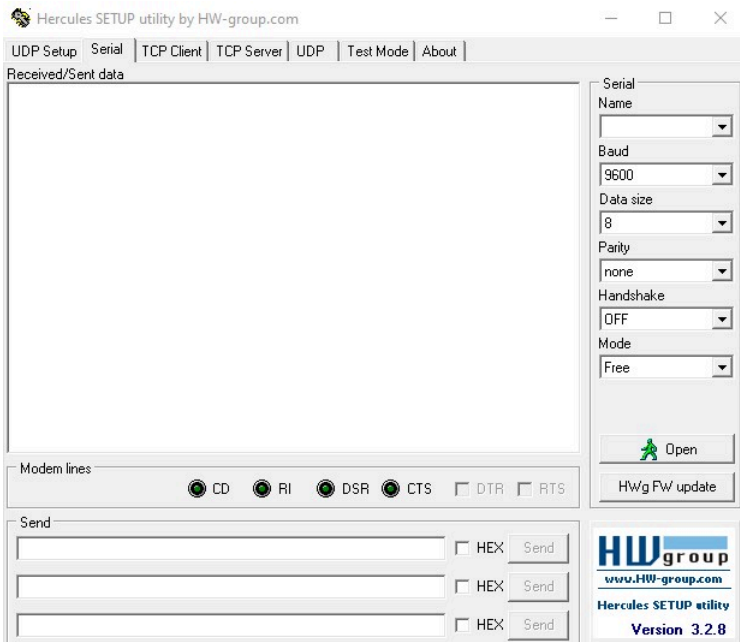

VISCA over IP

Avonic IP cameras are implemented with a TCP and an UDP server. The TCP as well as the UDP port are by default set to port [1259](#).



The default VISCA address setting is **always 1** when using VISCA over IP. As all cameras are uniquely identified by their IP address, all VISCA addresses are set to 1, the serial addressing plays no part. For VISCA over IP, every command starts with **81 xx xx xx**.



To control the camera, you need an TCP or UDP supported application, like **Hercules SETUP utility** or **Packet Sender** for example. Follow instructions below:

1. Open the TCP/ UDP supported application.
2. Fill in the camera's IP Address, TCP/UDP port number and connect the application to your camera.
Once the connection between client and server is configured, the client will be able to send PTZ commands to the server. The server then parses and executes the PTZ command.
3. Fill in the command to be sent to the camera. The camera will send you the return commands.
4. If you see the returned commands (in exception with UDP), the camera has executed the command. You can check this in the WebGUI of the camera.



Default settings:

- TCP port 1259
- UDP port 1259 (same port as TCP; is correct)
- VISCA address 1

The pictures below are showing an example of a VISCA command (Focus near) with their return commands. The green RX commands in the picture "Receive message" is the ACK command (to let the sender know that the command is received and executed) and the COM command (to confirm that the command has been successfully executed and completed). You can find these commands in the [Camera Return Command list](#) and the [Inquiry Command list](#).



The pictures below are ONLY an example to show you how a TCP supported application works. The pictures could be different from the application you are using.

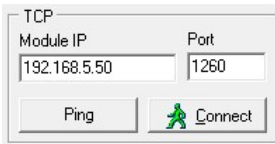

TCP configuration window showing Module IP: 192.168.5.50 and Port: 1260. Buttons for Ping and Connect are visible.

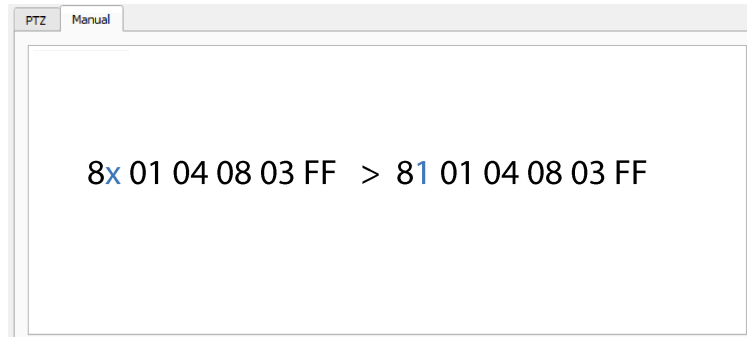

PTZ Manual window showing the command: 8x 01 04 08 03 FF > 81 01 04 08 03 FF

VISCA IP address and port

VISCA command example

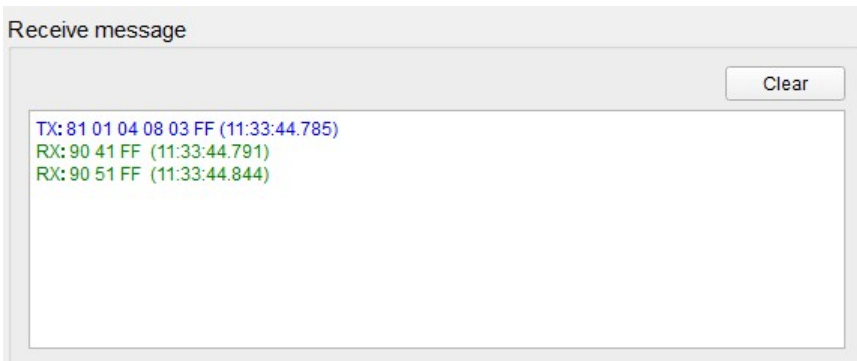

Receive message window showing TX: 81 01 04 08 03 FF (11:33:44.785), RX: 90 41 FF (11:33:44.791), and RX: 90 51 FF (11:33:44.844). A Clear button is present.

VISCA over IP using the full Sony VISCA protocol

All Avonic cameras are capable of being controlled using the UDP Sony version of VISCA consisting of long VISCA commands, including headers and message counters. The advantage of using this version of VISCA is the fact that the camera responds with the same header **counter** as was used in the command. This makes it possible to match each response to each command sent. This is especially helpful when programming automated camera control systems.



For the following example Hercules SETUP utility is used to recall preset 1 using VISCA. Follow instructions below:

1. Set the local port and camera port. Both must be set to **52381**. Any other port won't work!

The camera will send its answers back to the port that was used to send the command (port 52381).



Make sure that you have your **sent and receive** window set to display HEX data.

In the example below the camera is switched between:

- Preset 1: VISCA command 81 01 01 3F 02 01 FF and
- Preset 2: VISCA command 81 01 01 3F 02 02 FF



1. Type the command in the **Send** box. The command consists of the **(camera) address**, marked in blue and 7 bytes marked in red. This means that the complete VISCA command looks like this:
 - Preset 1: VISCA command 010000070000000181**0101F0201FF**
 - Preset 2: VISCA command 010000070000000581**013F0202FF**

The Visca over IP header consists of the 3rd and 4th bytes of the complete header. They indicate length of the payload (VISCA command). At this point, the value can vary depending on what VISCA command is sent. Using the example of **Preset Recall 1** from above:

- 010000070000000181**01013F0201FF** the 4th byte is '7' meaning the payload of the VISCA command is 7 bytes. Another point in the header is the message counter possibility on the 8th byte, in this instance it's '1'. On the second command where **Preset 2** was recalled, the message counter was set to '5'.



1. Click on **Send**. If you have done this correct, you should get the same as on the picture below:

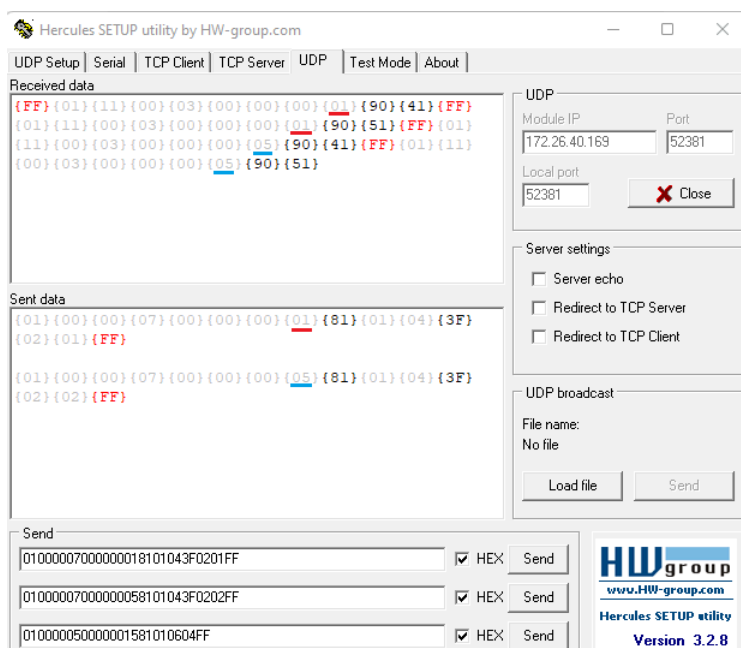

Camera Return Commands

All parameter values are in HEX.

- x = Camera Address
- y = Socket Number
- z = Camera Address + 8



This is one list for all Avonic PTZ Cameras (CM40 series, CM70 and CM90 series). Some features are CM70 and/or CM90 series specific and will not work in the CM40 series cameras.

Return/complete Command			
Command	Function	Command Packet	Comments
ACK/Completion Messages	ACK	90 4y FF (y: Socket No.)	Return when the command is accepted.
	Completion	90 5y FF (y: Socket No.)	Return when the command has been executed.

Error Command			
Command	Function	Command Packet	Comments
Error Messages	Syntax Error	90 60 02 FF	Returned when the command format is different or when a command with illegal command parameters is accepted.
	Command Buffer Full	90 60 03 FF	Indicates that two sockets are already being used (executing two commands) and the command could not be accepted when received.
	Command Canceled	90 6y 04 FF (y: Socket No.)	Returned when a command which is being executed in a socket specified by the cancel command is canceled. The completion message for the command is not returned.
	No Socket	90 6y 05 FF (y: Socket No.)	Returned when no command is executed in a socket specified by the cancel command, or when an invalid socket number is specified.
	Command Not Executable	90 6y 41 FF (y: Execution command Socket No. Inquiry command: 0)	Returned when a command cannot be executed due to current conditions. For example, when commands controlling the focus manually are received during auto-focus.

Camera Control Commands

All parameter values are in HEX

- x = Camera Address
- y = Socket Number
- z = Camera Address + 8

Camera Control Commands			
Command	Function	Command Packet	Comments
Address Set	Broadcast	88 30 01 FF	Address setting
CAM_Power	On	8x 01 04 00 02 FF	Power ON
	Off	8x 01 04 00 03 FF	Power OFF
	Reboot	8x 0A 01 06 01 FF	Reboot
CAM_Zoom	Stop	8x 01 04 07 00 FF	
	Tele (Standard speed)	8x 01 04 07 02 FF	
	Wide (Standard speed)	8x 01 04 07 03 FF	
	Tele (Variable speed)	8x 01 04 07 2p FF	p = 0(low speed) -F(high speed)
	Wide (Variable speed)	8x 01 04 07 3p FF	
	Direct	8x 01 04 47 0p 0q 0r 0s FF	pqrs(0-F): Zoom Position
	Zoom Wide ~ Tele	00 00 00 00 ~ 04 00 00 00 (PQRS)	
CAM_Focus	Stop	8x 01 04 08 00 FF	
	Far (Standard speed)	8x 01 04 08 02 FF	
	Near (Standard speed)	8x 01 04 08 03 FF	
	Far (Variable speed)	8x 01 04 08 2p FF	p = 0(low) - F(high)
	Near (Variable speed)	8x 01 04 08 3p FF	
	Direct Focus Position	8x 01 04 48 0p 0q 0r 0s FF	min p = 0, q = 0, r = 0, s = 0 max p = 0, q = 6, r = E, s = A
	Auto Focus	8x 01 04 38 02 FF	AF On
	Manual Focus	8x 01 04 38 03 FF	AF Off
	Auto/Manual	8x 01 04 38 10 FF	AF Toggle On/Off
	OnePush mode	8x 01 04 38 04 FF	
	OnePush trigger	8x 01 04 18 01 FF	
Focus Near ~ Far	Variable ~ 00 00 00 00 (PQRS)	pqrs: Focus Position	
CAM_WB	Auto	8x 01 04 35 00 FF	Normal Auto
	Indoor mode	8x 01 04 35 01 FF	Indoor mode
	Outdoor mode	8x 01 04 35 02 FF	Outdoor mode
	OnePush mode	8x 01 04 35 03 FF	One Push WB mode
	OnePush trigger	8x 01 04 10 05 FF	One Push WB Trigger
	Manual	8x 01 04 35 05 FF	Manual Control mode

Camera Control Commands			
Command	Function	Command Packet	Comments
CAM_Bgain	Reset	8x 01 04 04 00 FF	Manual Control of BGain
	Up	8x 01 04 04 02 FF	
	Down	8x 01 04 04 03 FF	
	Direct	8x 01 04 44 00 00 0p 0q FF	pq: B Gain
CAM_Rgain	Reset	8x 01 04 03 00 FF	Manual Control of RGain
	Up	8x 01 04 03 02 FF	
	Down	8x 01 04 03 03 FF	
	Direct	8x 01 04 43 00 00 0p 0q FF	pq: R Gain
CAM_AE	Full Auto	8x 01 04 39 00 FF	Automatic Exposure mode
	Manual	8x 01 04 39 03 FF	Manual Control mode
	Shutter priority	8x 01 04 39 0A FF	Shutter Priority Automatic Exposure mode
	Iris priority	8x 01 04 39 0B FF	Iris Priority Automatic Exposure mode
	Bright	8x 01 04 39 0D FF	Bright Mode (Manual control)
CAM_Iris	Reset	8x 01 04 0B 00 FF	Iris Setting (CAM_AE is set to Manual)
	Up	8x 01 04 0B 02 FF	
	Down	8x 01 04 0B 03 FF	
	Direct Iris Position	8x 01 04 4B 00 00 0p 0q FF	(Manual and Iris Priority) min p = 0 q = 0 max p = 0, q = C
CAM_Shutter	Direct	8x 01 04 4A 00 00 0p 0q FF	min p = 0 q = 0 max p = 1 q = 0
CAM_Gain	Reset	8x 01 04 0C 00 FF	Gain Setting
	Direct	8x 01 04 0C 00 00 0p 0q FF	pq: Gain Position 0 ~ 20 (0 = 00 HEX) Manual exposure
	Gain Limit	8x 01 04 2C 0p FF	p: Gain Position 0 ~ 15 (0 = 00 HEX) Auto exposure
CAM_Bright (only works with exposure mode Bright enabled)	Reset	8x 01 04 0D 00 FF	Bright Setting
	Up	8x 01 04 0D 02 FF	
	Down	8x 01 04 0D 03 FF	
	Direct	8x 01 04 0D 00 00 0p 0q FF	pq: Bright Position (0 ~ 23 max p = 1 and q = 7)
CAM_ExpComp(EV and EV Level)	On	8x 01 04 3E 02 FF	Exposure Compensation On/Off
	Off	8x 01 04 3E 03 FF	
	Reset	8x 01 04 0E 00 FF	Exposure Compensation Amount Setting
	Up	8x 01 04 0E 02 FF	
	Down	8x 01 04 0E 03 FF	
	Direct	8x 01 04 4E 00 00 0p 0q FF	
CAM_BackLight	On	8x 01 04 33 02 FF	Back Light Compensation On/Off
	Off	8x 01 04 33 03 FF	
CAM_NR(2D)Level	-	8x 01 04 53 0p FF	p: NR Setting (0: Off, level 1 to 7, 8 = AUTO)

Camera Control Commands			
Command	Function	Command Packet	Comments
CAM_NR(3D)Level	-	8x01 04 54 0p FF	p: NR Setting (0: Off, level 1 to 8)
CAM_Flicker	-	8x01 04 23 0p FF	p: Flicker Settings (0: Off, 1: 50Hz, 2: 60Hz)
CAM_DHotPixel	-	8x01 04 56 0p FF	p: Dynamic Hot Pixel Setting (0: Off, level 1 to 5)
CAM_Aperture (sharpness)	Reset	8x01 04 02 00 FF	Aperture Control
	Up	8x01 04 02 02 FF	
	Down	8x01 04 02 03 FF	
	Direct	8x01 04 42 00 00 0p 0q FF	pq: Aperture Gain
CAM_PictureEffect	Off	8x01 04 63 00 FF	Picture Effect Setting
	B&W	8x01 04 63 04 FF	
CAM_Memory(preset)	Reset	8x01 04 3F 00 pp FF	pp: Memory Number (=0 to 127)
	Set	8x01 04 3F 01 pp FF	
	Recall	8x01 04 3F 02 pp FF	
CAM_LR_Reverse	On	8x01 04 61 02 FF	Image Flip Horizontal On/Off
	Off	8x01 04 61 03 FF	
CAM_PictureFlip	On	8x01 04 66 02 FF	Image Flip Vertical On/Off
	Off	8x01 04 66 03 FF	
Freeze (CM70 series ONLY)	Freeze ON	8x04 04 62 02 FF	Freeze ON immediately
	Freeze OFF	8x04 04 62 03 FF	Freeze OFF immediately
	Preset Freeze ON	8x04 04 62 22 FF	Freeze ON when running preset
	Preset Freeze OFF	8x04 04 62 23 FF	Freeze OFF when running preset
SYS_Menu	Off	8x01 06 06 03 FF	Turns the OSD menu On/Off
	On	8x01 06 06 02 FF	
CAM_ColorGain	Direct	8x01 04 49 00 00 00 0P FF	p: Color Gain setting 0h (60%) to Eh (200%)

Camera Control Commands			
Command	Function	Command Packet	Comments
Pan_tiltDrive	Up	8x01 06 01 VV WW 03 01 FF	VV: Pan speed 0x01 (low speed) to 0x18 (high speed) WW: Tilt speed 0x01 (low speed) to 0x14 (high speed) YYYY: Pan Position ZZZZ: Tilt Position
	Down	8x01 06 01 VV WW 03 02 FF	
	Left	8x01 06 01 VV WW 01 03 FF	
	Right	8x01 06 01 VV WW 02 03 FF	
	Upleft	8x01 06 01 VV WW 01 01 FF	
	Upright	8x01 06 01 VV WW 02 01 FF	
	DownLeft	8x01 06 01 VV WW 01 02 FF	
	DownRight	8x01 06 01 VV WW 02 02 FF	
	Stop	8x01 06 01 VV WW 03 03 FF	

Camera Control Commands			
Command	Function	Command Packet	Comments
	AbsolutePosition	8x 01 06 02 VV WW 0Y 0Y 0Y 0Y 0Z 0Z 0Z 0Z FF	
	RelativePosition	8x 01 06 03 VV WW 0Y 0Y 0Y 0Y 0Z 0Z 0Z 0Z FF	
	Pan range: -170° ~ +170°	0F 06 07 00 ~ 50 00 09 09 (YYYY)	
	Tilt range: -30° ~ +90°	0F 0E 04 05 ~ 00 05 01 00 (ZZZZ)	
	Home	8x 01 06 04 FF	
	Reset	8x 01 06 05 FF	
Pan_tiltLimitSet	LimitSet	8x 01 06 07 00 0W 0Y 0Y 0Y 0Y 0Z 0Z 0Z 0Z FF	W: 1 UpRight 0: Down-Left YYYY: Pan Limit Position ZZZZ: Tilt Position
	LimitClear	8x 01 06 07 01 0W 07 0F 0F 0F 0F 0F 0F 0F FF	
CAM_AFsensitivity	High	8x 01 04 58 01 FF	AF Sensitivity High/Normal/Low
	Normal	8x 01 04 58 02 FF	
	Low	8x 01 04 58 03 FF	
CAM_SettingReset	Reset	8x 01 04 A0 10 FF	Reset Factory Setting
CAM_Brightness	Direct	8x 01 04 A1 00 00 0p 0q FF	pq: Brightness Position
CAM_Contrast	Direct	8x 01 04 A2 00 00 0p 0q FF	pq: Contrast Position
CAM_Flip	Off	8x 01 04 A4 00 FF	Single Command For Video Flip
	Flip-H	8x 01 04 A4 01 FF	
	Flip-V	8x 01 04 A4 02 FF	
	Flip-HV	8x 01 04 A4 03 FF	
CAM_Autoflip	Autoflip ON	8x 01 02 70 02 FF	Autoflip ON
	Autoflip OFF	8x 01 02 70 03 FF	Autoflip OFF
CAM_SettingSave	Save	8x 01 04 A5 10 FF	Save Current Setting
CAM_Iridix	Direct	8x 01 04 A7 00 00 0p 0q FF	pq: Iridix Position
CAM_AWBSensitivity	High	8x 01 04 A9 00 FF	High
	Normal	8x 01 04 A9 01 FF	Normal
	Low	8x 01 04 A9 02 FF	Low
CAM_AFZone	Front Focus	8x 01 04 AA 00 FF	AF Zone select
	Back Focus	8x 01 04 AA 01 FF	
	Meeting	8x 01 04 AA 02 FF	
	Moving Objects	8x 01 04 AA 03 FF	
	Center Focus	8x 01 04 AA 04 FF	
CAM_ColorHue	Direct	8x 01 04 4F 00 00 00 0p FF	p: Color Hue setting 0h (- 14 degrees) to Eh (+14 degrees)
Pan-tilt_MaxSpeed	High SpeedPan/Tilt ON	8x 0A 01 31 03 FF	High Speed PTON
	High SpeedPan/Tilt OFF	8x 0A 01 31 02 FF	High Speed PTOFF
ARM/MCU_Version	Inquiry ARM/MCU Version	8x 09 0A 01 03 FF	Returned version in HEX, for example: 02 05 00 (version 2.5.0)
CAM/UVC_Version	Inquiry Cam/UVC version	8x 09 00 02 FF	Returned version in HEX, for example: 02 05 09 (version 2.5.9)

Camera Control Commands			
Command	Function	Command Packet	Comments
CAM_TallyLight(Cm7x only with license active)	Red	8x01 7E01 0A00 0203 FF	Tally Light RedON
	Green	8x01 7E01 0A00 0302 FF	Tally Light GreenON
	Off	8x01 7E01 0A00 0303 FF	Tally Light OFF
Preset_H_Speed	Horizontal (Pan) speed between presets	8x01 0301 qq FF	qq= speed setting1 ~ 25 (1 = 00 HEX, 25 = 18 HEX)
Preset_V_Speed	Vertical (Tilt) speed between presets	8x01 0302 qq FF	qq = speed setting1 ~ 21 (1 = 00 HEX, 21 = 14 HEX)
Preset_Z_Speed	Zoom speed between presets	8x01 0303 qq FF	qq = speed setting1 ~ 8 (1 = 00 HEX, 8 = 07 HEX)
Blue_Tuning (autowhitebalance active)	more or less blue while maintaining auto white balance active	8x0A 01 13 pp FF	pp = setting -10 ~ +10(00~14 HEX)
Red_Tuning (autowhitebalance active)	more or less red while maintaining auto white balance active	8x0A 01 12 pp FF	pp = setting -10 ~ +10(00~14 HEX)

Camera Control Commands			
Command	Function	Command Packet	Comments
VideoSystem_Set (CM40 series: It is possible to set the video format, but since the video format is dictated by the computer the camera is connected with, the picture will NOT change to that format.)		8x01 06 35 00 pp FF	pp: Video Format
			00: 1080p60
			01: 1080p50
			02: 1080i60
			03: 1080i50
			04: 720p60
			05: 720p50
			06: 1080p30
			07: 1080p25
			08: 720p30
			09: 720p25
			0A: 1080p59.94
			0B: 1080i59.94
0C: 720p59.94			
0D: 1080p29.97			
0E: 720p29.97			

Inquiry Commands

all parameter values are in hex

- x = camera address
- y = socket number
- z = camera address + 8

Inquiry Commands			
Command	Function	Command Packet	Comments
CAM_ZoomPosInq	8x 09 04 47 FF	90 50 0p 0q 0r 0s FF	pqrs: Zoom Position
CAM_FocusAFModelnq	8x 09 04 38 FF	90 50 02 FF	Auto Focus
		90 50 03 FF	Manual Focus
		90 50 04 FF	OnePush Focus
CAM_FocusPosInq	8x 09 04 48 FF	90 50 0p 0q 0r 0s FF	pqrs: Focus Position
CAM_WBModelnq	8x 09 04 35 FF	90 50 00 FF	Auto
		90 50 01 FF	Indoor mode
		90 50 02 FF	Outdoor mode
		90 50 03 FF	OnePush mode
		90 50 05 FF	Manual
CAM_RGainInq	8x 09 04 43 FF	90 50 00 00 0p 0q FF	pq: R Gain
CAM_BGainInq	8x 09 04 44 FF	90 50 00 00 0p 0q FF	pq: B Gain
CAM_GainInq (CM70 series ONLY)	8x 09 04 0C FF	90 50 00 FF	Manual Exposure Direct Gain
CAM_AEModelnq	8x 09 04 39 FF	90 50 00 FF	Full Auto
		90 50 03 FF	Manual
		90 50 0A FF	Shutter priority
		90 50 0B FF	Iris priority
		90 50 0D FF	Bright
CAM_ShutterPosInq	8x 09 04 4A FF	90 50 00 00 0p 0q FF	pq: Shutter Position
CAM_IrisPosInq	8x 09 04 4B FF	90 50 00 00 0p 0q FF	pq: Iris Position
CAM_BrightPosInq	8x 09 04 4D FF	90 50 00 00 0p 0q FF	pq: Bright Position
CAM_ExpComp-Modelnq	8x 09 04 3E FF	90 50 02 FF	On
		90 50 03 FF	Off
CAM_ExpCompPosInq	8x 09 04 4E FF	90 50 00 00 0p 0q FF	pq: ExpComp Position
CAM_Backlight-Modelnq	8x 09 04 33 FF	90 50 02 FF	On
		90 50 03 FF	Off
CAM_Noise2DLevel	8x 09 04 53 FF	90 50 0p FF	Noise Reduction (2D) p: 0 to 7, 8 = AUTO
CAM_Noise3DLevel	8x 09 04 54 FF	90 50 0p FF	Noise Reduction (3D) p: 0 to 8
CAM_FlickerModelnq	8x 09 04 55 FF	90 50 0p FF	p: Flicker Settings(0: OFF, 1: 50Hz, 2: 60Hz)
CAM_Aperture-Modelnq (Sharpness)	8x 09 04 05 FF	90 50 02 FF	Auto Sharpness
		90 50 03 FF	Manual Sharpness
CAM_ApertureInq(Sharpness)	8x 09 04 42 FF	90 50 00 00 0p 0q FF	pq: Aperture Gain
CAM_PictureEffectModelnq	8x 09 04 63 FF	90 50 00 FF	Color
		90 50 04 FF	B&W

Inquiry Commands			
Command	Function	Command Packet	Comments
CAM_MemoryInq	8x 09 04 3F FF	90 50 0p FF	p: Memory (Preset) number last operated.
SYS_MenuModelInq	8x 09 06 06 FF	90 50 02 FF	On
		90 50 03 FF	Off
CAM_LR_ReverseInq	8x 09 04 61 FF	90 50 02 FF	On
		90 50 03 FF	Off
CAM_PictureFlipInq	8x 09 04 66 FF	90 50 02 FF	On
		90 50 03 FF	Off
CAM_ColorGainInq	8x 09 04 49 FF	90 50 00 00 00 0p FF	p: Color Gain setting 0h (60%) to Eh (200%)
CAM_BTuningInq	81 09 0A 01 13 FF	90 50 pp FF	pp = setting -10 ~ +10 (00~14 HEX)
CAM_RTuningInq	81 09 0A 01 12 FF	90 50 pp FF	pp = setting -10 ~ +10 (00~14 HEX)
VideoSystemInq (CM40 series: It is possible to set the video format, but since the video format is dictated by the computer the camera is connected with, the picture will not change to that format.)	8x 09 06 23 FF	90 50 00 FF	1920x1080p60
		90 50 01 FF	1920x1080p50
		90 50 02 FF	1920x1080i60
		90 50 03 FF	1920x1080i50
		90 50 04 FF	1280x720p60
		90 50 05 FF	1280x720p50
		90 50 06 FF	1920x1080p30
		90 50 07 FF	1920x1080p25
		90 50 08 FF	1280x720p30
		90 50 09 FF	1280x720p25
		90 50 0A FF	1920x1080p59.94
		90 50 0B FF	1920x1080i59.94
		90 50 0C FF	1280x720p59.94
		90 50 0D FF	1920x1080p29.97
90 50 0E FF	1280x720p29.97		
Pan-tiltMaxSpeedInq	8x 09 06 11 FF	90 50 ww zz FF	ww: Pan Max Speed zz: Tilt Max Speed
Pan-tiltPosInq	8x 09 06 12 FF	90 50 0w 0w 0w 0w 0z 0z 0z 0z FF	www: Pan Position zzz: Tilt Position
CAM_GainLimitInq	8x 09 04 2C FF	90 50 0q FF	p: Gain Limit
	8x 09 04 2C FF	90 50 07 FF	Auto exposure
CAM_DHotPixelInq	8x 09 04 56 FF	90 50 0q FF	p: Dynamic Hot Pixel Setting (0: Off, level 1 to 6)
CAM_AFSensitivityInq	8x 09 04 58 FF	90 50 01 FF	High
		90 50 02 FF	Normal
		90 50 03 FF	Low
CAM_BrightnessInq	8x 09 04 A1 FF	90 50 00 00 0p 0q FF	pq: Brightness Position
CAM_ContrastInq	8x 09 04 A2 FF	90 50 00 00 0p 0q FF	pq: Contrast Position

Inquiry Commands			
Command	Function	Command Packet	Comments
CAM_FlipInq	8x 09 04 A4 FF	90 50 00 FF	Off
		90 50 01 FF	Flip-H
		90 50 02 FF	Flip-V
		90 50 03 FF	Flip-HV
CAM_IridixInq	8x 09 04 A7 FF	90 50 00 00 0p 0q FF	pq: Iridix Position
CAM_AFZone	8x 09 04 AA FF	90 50 00 FF	Front Focus
		90 50 01 FF	Back Focus
		90 50 02 FF	Meeting
		90 50 03 FF	Moving Objects
		90 50 04 FF	Center Focus
CAM_ColorHueInq	8x 09 04 4F FF	90 50 00 00 00 0p FF	p: Color Hue setting 0h (-14 degrees) to Eh (+14 degrees)
CAM_AWBSensitivityInq	81 09 04 A9 FF	90 50 00 FF	High
		90 50 01 FF	Normal
		90 50 02 FF	Low
CAM_ZoomPosInq	8x 09 04 47 FF	90 50 0p 0q 0r 0s FF	pqrs: Zoom Position
CAM_FocusAFModelInq	8x 09 04 38 FF	90 50 02 FF	Auto Focus
		90 50 03 FF	Manual Focus
CAM_FocusPosInq	8x 09 04 48 FF	90 50 0p 0q 0r 0s FF	pqrs: Focus Position

Inquiry Commands			
Command	Function	Command Packet	Comments
CAM_WBModelInq	8x 09 04 35 FF	90 50 00 FF	Auto
		90 50 01 FF	Indoor mode
		90 50 02 FF	Outdoor mode
		90 50 03 FF	OnePush mode
		90 50 05 FF	Manual
CAM_RGainInq	8x 09 04 43 FF	90 50 00 00 0p 0q FF	pq: R Gain
CAM_BGainInq	8x 09 04 44 FF	90 50 00 00 0p 0q FF	pq: B Gain
CAM_AEModelInq	8x 09 04 39 FF	90 50 00 FF	Full Auto
		90 50 03 FF	Manual
		90 50 0A FF	Shutter priority
		90 50 0B FF	Iris priority
		90 50 0D FF	Bright
CAM_ShutterPosInq	8x 09 04 4A FF	90 50 00 00 0p 0q FF	pq: Shutter Position
CAM_IrisPosInq	8x 09 04 4B FF	90 50 00 00 0p 0q FF	pq: Iris Position
CAM_BrightPosInq	8x 09 04 4D FF	90 50 00 00 0p 0q FF	pq: Bright Position
CAM_PowerInq	8x 09 04 00 FF	y0 50 02 FF	On
		y0 50 03 FF Off	Off (Standby)

APPENDIX B - DIMENSIONS

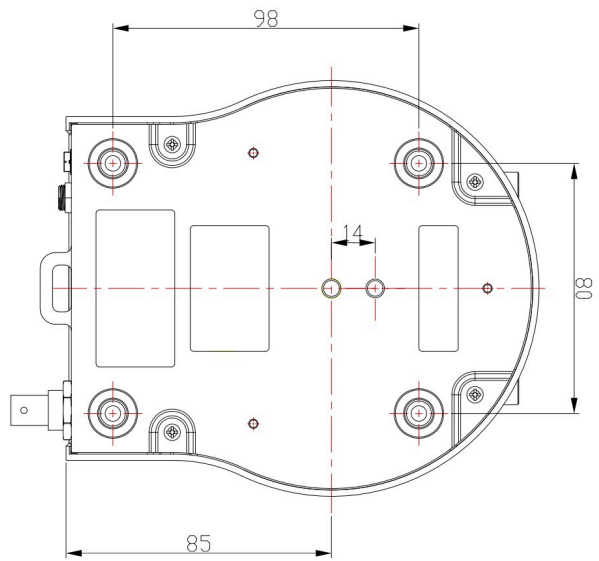
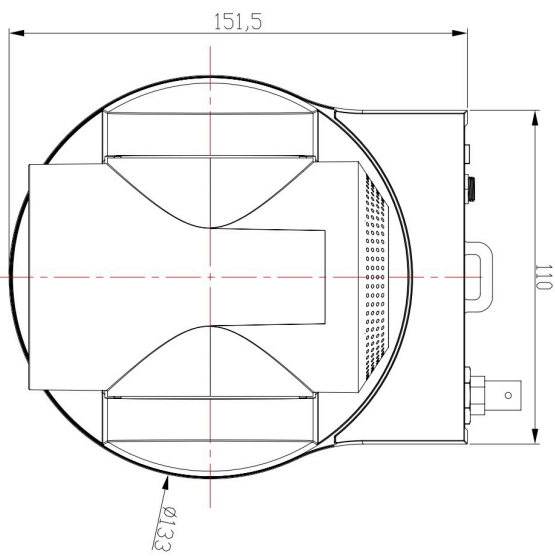
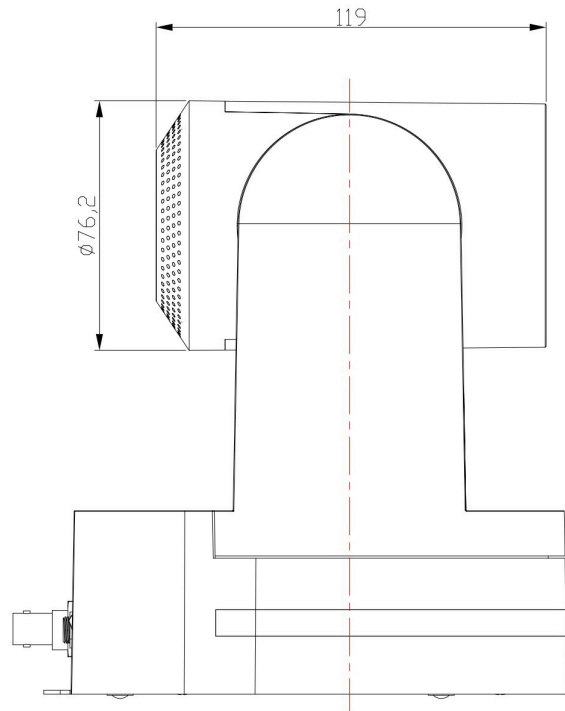
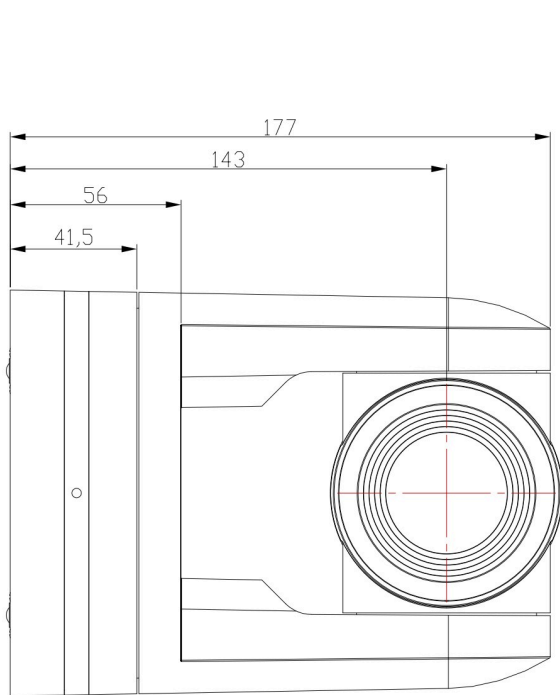

APPENDIX C - HTTP API

With the HTTP API you can control the camera by using a web browser like Microsoft Edge or Google Chrome. It is possible to change multiple settings at once using this feature. This document is available as an Appendix in the CM70 series manual and as a separate document that can be downloaded on the [product website](#).

How to use HTTP API

All codes in the [HTTP API code list](#) are clickable. Do **NOT** click **left** on these codes!



Follow instructions below:

1. **Click right** and click (left) to COPY the link.

The screenshot shows a table titled "HTTP API code list" with sections for "IR Remote Control" and "PTZ". A context menu is open over a link in the "IR Remote Control" section, showing options like "Copy link", "Rotate clockwise", and "Inspect".

IR Remote Control			
IR Enable/Disable			
Command	Code	Command	Setting
szCmd	http://192.168.5.126/ajaxcom?szCmd={\"SetEnv\":{\"ArmPtz\":{\"btrCtrlEnable\":0}}}	btrCtrlEnable	0: ON 1: OFF

PTZ			
PTZControl			
Command	Setting	Function	Command
nChanel	0		
byValue	0,100 used to control the speed of ptz		

2. Paste the link in your browser like this (all the brackets are replaced by percentages. This is normal, ignore it):

```
http://192.168.5.126/ajaxcom?szCmd=%7B%22SysCtrl%22:%7B%22PtzCtrl%22:%7B%22nChanel%22:0,%22szPtzCmd%22:%22left_start%22,%22byValue%22:50%7D%7D%7D
```

3. The IP Address in this link is an **example of an IP address**. Change this IP Address to the one you use for your camera. See [Network > Ethernet > IP Address](#).
4. Change the settings in the link. In this case:

```
http://192.168.5.126/ajaxcom?szCmd=%7B%22SysCtrl%22:%7B%22PtzCtrl%22:%7B%22nChanel%22:0,%22szPtzCmd%22:%22left_start%22,%22byValue%22:50%7D%7D%7D
```

5. Press **ENTER**. If **correct**, you get in return:

```
http://192.168.5.126/ajaxcom?szCmd=%7B%22SysCtrl%22:%7B%22PtzCtrl%22:%7B%22nChanel%22:0,%22szPtzCmd%22:%22left_start%22,%22byValue%22:50%7D%7D%7D
{"nRetVal":0, "szError":""}
```

If **failed**, you get in return.

```
http://192.168.5.126/ajaxcom?szCmd=%7B%22SysCtrl%22:%7B%22PtzCtrl%22:%7B%22nChanel%22:0,%22szPtzCmd%22:%22left_start%22,%22byValue%22:50%7D%7D%7D
{"nRetVal":-1879048185, "szError":""}
```

6. In case of a failed return, check the following:
 - Syntax errors in the code/ correct numbers in the key values. Some camera settings are having a specific range. The SRT key for example has a range of 0 - 32. If you have typed 33 it would exceed the range of this key.
 - No long white spaces between the key values of the code. For example this " code " is error and this "code" is right.
 - If you have entered the correct IP address of the camera.
7. If you have performed the process accurately, you can verify the settings within the camera's WebGUI.

Curl

It is also possible to change the camera settings at once by using the **Command Prompt** from Windows.



Follow instructions below:

1. Click on **Start** in the left corner of your screen in Windows.
2. Type **Notepad** and open this application.
3. Copy and paste the following http link from the [HTTP API code list](#) (for example: `http://192.168.5.126/ajaxcom?szCmd={\"GetEnv\":{\"VideoParam\":{\"nChannel\":-1}}}`)
4. Type **curl**, change the default IP address in the IP Address of your camera, and surround it by quotation marks.
5. Add **--data-raw** between the http link and the code.
6. Type **szCmd** and surround it by quotation marks.
7. **Double** the quotation marks between the brackets! See the example below.

```

4      5      6      7
curl "http://172.26.40.147/ajaxcom" --data-raw "szCmd={\"SetEnv\":{\"VideoParam\":{\"stAF\":{\"emAFMode\":3,\"nChannel\":0}}}"
    |          |          |          |
    Changed link (IP address camera) Code from the HTTP API code list
  
```

8. Modify the parameters in the code. In the example above **EmAFmode:3** and **nChannel:0** See the [HTTP API code list](#).
9. Click on **Start** in Windows again, type **CMD** and press **Enter**.
10. Copy and paste the link/ code from notepad in **Command Prompt** and press **Enter**. If correct it returns: `{\"nRetVal\":0,\"szError\":\"\"}`

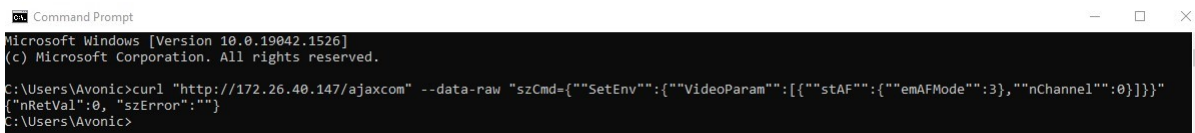

{\"GetEnv\"}

You can use the HTTP API to **display the current settings** of the camera in your browser or in the **Command Prompt** application. You need the {\"GetEnv\"} codes from the HTTP API code list to do this. If correct you see the following in your webbrowser, or in Command Prompt:

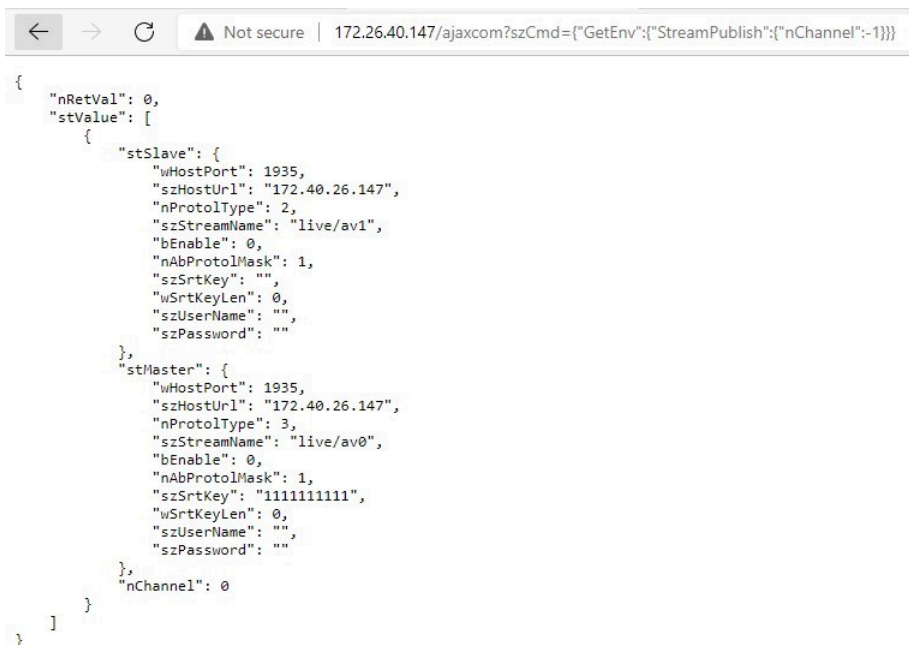

```

Microsoft Windows [Version 10.0.19044.1526]
(c) Microsoft Corporation. All rights reserved.

C:\Users\Avonic>curl "http://172.26.40.147/ajaxcom" --data-raw "szCmd={"GetEnv":{"StreamPublish":{"nChannel":-1}}}"
{
  "nRetVal": 0,
  "stValue": [
    {
      "stSlave": {
        "wHostPort": 1935,
        "szHostUrl": "172.40.26.147",
        "nProtoType": 2,
        "szStreamName": "live/av1",
        "bEnable": 0,
        "nAbProtoMask": 1,
        "szSrtKey": "",
        "wSrtKeyLen": 0,
        "szUserName": "",
        "szPassword": ""
      },
      "stMaster": {
        "wHostPort": 1935,
        "szHostUrl": "172.40.26.147",
        "nProtoType": 3,
        "szStreamName": "live/av0",
        "bEnable": 0,
        "nAbProtoMask": 1,
        "szSrtKey": "1111111111",
        "wSrtKeyLen": 0,
        "szUserName": "",
        "szPassword": ""
      }
    },
    {
      "nChannel": 0
    }
  ]
}
C:\Users\Avonic>

```

HTTP API code list

IR Remote Control

IR Enable/Disable			
Command	Code	Command	Setting
szCmd	http://192.168.5.126/ajaxcom?szCmd={"SetEnv":{"ArmPtz":{"blrCtrlEnable":0}}}	blrCtrlEnable	0: ON
			1: OFF

PTZ

PTZControl			
Command	Setting	Function	Command
Code: http://192.168.5.126/ajaxcom?szCmd={"SysCtrl":{"PtzCtrl":{"nChanel":0,"szPtzCmd":"left_start","byValue":50}}}			
nChanel	0		
byValue	0,100 used to control the speed of ptz		
szPtzCmd			
		left start	left_start
		left stop	left_stop
		leftup start	leftup_start
		leftup stop	leftup_stop
		leftdown start	leftdown_start
		leftdown stop	leftdown_stop
		rightstart	right_start
		rightstop	right_stop
		rightup start	rightup_start
		rightdown start	rightdown_start
		rightdown stop	rightdown_stop
		upstart	up_start
		upstop	up_stop
		downstart	down_start
		downstop	down_stop

PTZ speed

Set PTZ Speed			
Command	Code	Command	Setting
szCmd	http://192.168.5.126/ajaxcom?szCmd={"SetEnv":{"PTZSpeed":{"nPTZSpeed":1}}	nPTZSpeed	0: Slow 1: High

Speed by Zoom

Set Speed By Zoom			
Command	Code	Command	Setting
szCmd	http://192.168.5.126/ajaxcom?szCmd={"SetEnv":{"ArmPtz":{"bSpeedByZoom":0}}	bSpeedByZoom	1: on 0: off

Image Freezing

Set Image Freezing			
Command	Code	Command	Setting
szCmd	http://192.168.5.126/ajaxcom?szCmd={"SetEnv":{"ArmPtz":{"blmageFreezing":0}}	blmageFreezing	1: on 0: off

Low power mode

Set Low Power Mode			
Command	Code	Command	Setting
szCmd	http://192.168.5.126/ajaxcom?szCmd={"SetEnv":{"ArmPtz":{"emLowPowerMode":0}}	emLowPowerMode	2: on 3: off

Zoom Speed

Set Zoom Speed			
Command	Code	Command	Setting
szCmd	http://192.168.5.126/ajaxcom?szCmd={"SetEnv":{"ArmPtz":{"nZoomSpeed":0}}	nZoomSpeed	0-7

Preset Pan Speed

Set Preset Pan Speed			
Command	Code	Command	Setting
szCmd	http://192.168.5.126/ajaxcom?szCmd={"SetEnv":{"ArmPtz":{"nPresetPanSpeed":0}}	nPresetPanSpeed	0-24

Preset Tilt Speed

Set Preset Tilt Speed			
Command	Code	Command	Setting
szCmd	http://192.168.5.126/ajaxcom?szCmd={"SetEnv":{"ArmPtz":{"nPresetTiltSpeed":0}}	nPresetTiltSpeed	0-20

Preset Zoom Speed

Set Preset Zoom Speed			
Command	Code	Command	Setting
szCmd	http://192.168.5.126/ajaxcom?szCmd={"SetEnv":{"ArmPtz":{"nPresetZoomSpeed":0}}	nPresetZoomSpeed	0-7

Focus Mode

Focus Mode Commands			
Focus Mode			
Code	http://192.168.5.126/ajaxcom?szCmd={"SetEnv":{"VideoParam":{"stAF":{"emAFMode":3,"nChannel":0}}}}		
Command	Setting		
nChanel	0		
emAFMode	2: Auto		
	3: Manual		
	4 OnePush		
Zoom and focus			
Code	http://192.168.5.126/ajaxcom?szCmd={"SysCtrl":{"PtzCtrl":{"nChanel":0,"szPtzCmd":"zoomdec_start","byValue":0}}}		
Command	Setting	Function	Command
nChanel	0		
byValue	0		
szPtzCmd			
		Zoom add start	zoomadd_start
		Zoom add stop	zoomadd_stop
		Zoom decrease stop	zoomdec_start
		Zoom decrease stop	zoomdec_stop
		Focus add start	focusadd_start
		Focus add stop	focusadd_stop
		Focus decrease start	focusdec_start
		Focus decrease stop	focusdec_stop

Preset

Preset Commands			
Code	http://192.168.5.126/ajaxcom?szCmd={"SysCtrl":{"PtzCtrl":{"nChanel":0,"szPtzCmd":"preset_set","byValue":0}}}		
Command	Setting	Function	Command
nChanel	0s		
ByValue	0, 254		
szPtzCmd			
		Set preset	preset_set
		Call preset	preset_call
		Clean preset	preset_clean

Audio

Audio Configure	
Get audio configure	
Code	http://192.168.5.126/ajaxcom?szCmd={"GetEnv":{"Audio":{}}}
Set audio configure	
Code	http://192.168.5.126/ajaxcom?szCmd={"SetEnv":{"Audio":{"nSampleBits":16,"nAudioSmstMask":[33554888,33554888,33554433],"bEnable":0,"nInpVolume":4,"nBitRate":64,"nEncType":7,"byAudioCodeList":[6,7,2],"nSampleRate":44100,"nChannel":1}}}

Audio Configure			
Function	Code	Command	Setting
Enable	<code>http://192.168.5.126/ajaxcom?szCmd={"SetEnv":{"Audio":{"bEnable":1}}}</code>	bEnable	0: off 1: on
Encode Type	<code>http://192.168.5.126/ajaxcom?szCmd={"SetEnv":{"Audio":{"nEncType":7}}}</code>	nEncType	6: Mp3AAC 7: G.711A 2:
Sample Rate	<code>http://192.168.5.126/ajaxcom?szCmd={"SetEnv":{"Audio":{"nSampleRate":32000}}}</code>	nSampleRate (Only supporting these sample rates and g.711a can only be 8000.)	16000 32000 44100 48000
Sample Bits	<code>http://192.168.5.126/ajaxcom?szCmd={"SetEnv":{"Audio":{"nSampleBits":16}}}</code>	nSampleBits	16
Bit Rate	<code>http://192.168.5.126/ajaxcom?szCmd={"SetEnv":{"Audio":{"nBitRate":96}}}</code>	nBitRate	32 48 64 96 128
Channel	<code>http://192.168.5.126/ajaxcom?szCmd={"SetEnv":{"Audio":{"nChannel":2}}}</code>	nChannel	1: Mono 2: Stereo
Input Volume	<code>http://192.168.5.126/ajaxcom?szCmd={"SetEnv":{"Audio":{"nInpVolume":5}}}</code>	nInpVolume (range 1 to 10)	Exp:[1, 10]

Video

Video encoder

Video Encode	
Get video encode parameters	
Code	<code>http://192.168.5.126/ajaxcom?szCmd={"GetEnv":{"VideoEncode":{"nChannel":-1}}}</code>
Set video encode parameters	
Code	<code>http://192.168.5.126/ajaxcom?szCmd={"SetEnv":{"VideoEncode":{"stSlave":{"byFrameMinQP":20,"byImageQuality":1,"szStreamName":"live/av1","dwVideoCodecMask":160,"emBitRateCtrl":0,"byImageSizeList":[26,7,9,27,4,5],"dwMaxBitRate":40960,"nFrameRate":25,"nMaxFrameRate":30,"emVideoCodec":5,"nFrameInterval":75,"emImageSize":27,"nBitRate":512,"byProfile":2},"stMaster":{"byFrameMinQP":20,"byImageQuality":0,"szStreamName":"live/av0","dwVideoCodecMask":160,"emBitRateCtrl":0,"byImageSizeList":[5,4,9],"dwMaxBitRate":40960,"nFrameRate":25,"nMaxFrameRate":60,"emVideoCodec":5,"nFrameInterval":75,"emImageSize":5,"nBitRate":4096,"byProfile":2,"nChannel":0}}}}</code>

Video encode settings

Video Encode Settings			
Function	Code	Command	Setting
Compressed Format	<code>http://192.168.5.126/ajaxcom?szCmd={"SetEnv":{"VideoEncode":{"stMaster":{"emVideoCodec":5,"nChannel":0}}}</code>	emVideoCodec	5: H.264 7: H.265 (BP profile only)
Profile	<code>http://192.168.5.126/ajaxcom?szCmd={"SetEnv":{"VideoEncode":{"stMaster":{"byProfile":0,"nChannel":0}}}</code>	byProfile	0: BP 1: MP 2: HP
	<code>http://192.168.5.126/ajaxcom?szCmd={"GetEnv":{"VideoEncode":{"nChannel":-1}}}</code> and receive its returning value. Compared to webpage and this, you can know the different value meaning different image size.	byImageSizeList (Lists all imagesize, different products have different image size)	

Video Encode Settings			
Image Size	<code>http://192.168.5.126/ajaxcom?szCmd={"SetEnv":{"VideoEncode":{"stMaster":{"emlImageSize":4,"nChannel":0}}}}</code>	emlImageSize	5: 1920*1080 4: 1280*720 9: 640*480 27: 320*180 26: 640*360
Rate Control	<code>http://192.168.5.126/ajaxcom?szCmd={"SetEnv":{"VideoEncode":{"stMaster":{"emBitRateCtrl":1,"nChannel":0}}}}</code>	emBitRateCtrl	0: CBR 1: VBR

Video Encode Settings			
Function	Code	Command	Setting
Image Quality	<code>http://192.168.5.126/ajaxcom?szCmd={"SetEnv":{"VideoEncode":{"stMaster":{"bylImageQuality":5,"nChannel":0}}}}</code>	bylImageQuality	0: worst quality 1: between 2: between 3: between 4: between 5: Best quality
Bit Rate (kb/s)	<code>http://192.168.5.126/ajaxcom?szCmd={"SetEnv":{"VideoEncode":{"stMaster":{"dwMaxBitRate":200,"nChannel":0}}}}</code>	dwMaxBitRate	[64, 40960]
Frame Rate (F/S)	<code>http://192.168.5.126/ajaxcom?szCmd={"SetEnv":{"VideoEncode":{"stMaster":{"nFrameRate":25,"nChannel":0}}}}</code>	nFrameRate	[5, 60]
Frame Interval	<code>http://192.168.5.126/ajaxcom?szCmd={"SetEnv":{"VideoEncode":{"stMaster":{"nlFrameInterval":70,"nChannel":0}}}}</code>	nlFrameInterval	[1, 300]
Frame Min QP	<code>http://192.168.5.126/ajaxcom?szCmd={"SetEnv":{"VideoEncode":{"stMaster":{"bylFrameMinQP":70,"nChannel":0}}}}</code>	bylFrameMinQP	[10, 51]
Stream Name	<code>http://192.168.5.126/ajaxcom?szCmd={"SetEnv":{"VideoEncode":{"stMaster":{"szStreamName":"live/av01","nChannel":0}}}}</code>	szStreamName	user-defined

Video Streaming

Stream Publish			
Get stream publish parameters			
Code	<code>http://192.168.5.126/ajaxcom?szCmd={"GetEnv":{"StreamPublish":{"nChannel":-1}}}}</code>		
Set stream publish parameters			
Code	<code>http://192.168.5.126/ajaxcom?szCmd={"SetEnv":{"StreamPublish":{"stSlave":{"wHostPort":1935,"szHostUrl":"192.168.5.11","nProtoType":2,"szStreamName":"live/av1","bEnable":0,"nAbProtoMask":1,"szSrtKey":"","wSrtKeyLen":0,"szUserName":"","szPassword":"","stMaster":{"wHostPort":1935,"szHostUrl":"192.168.5.11","nProtoType":3,"szStreamName":"live/av0","bEnable":0,"nAbProtoMask":1,"szSrtKey":"111111111","wSrtKeyLen":0,"szUserName":"","szPassword":"","nChannel":0}}}}</code>		
NOTE: When modifying one param, you should take along wHostPort. Otherwise, the host port will be zero.			
Function	Code	Command	Setting
Enable	<code>http://192.168.5.126/ajaxcom?szCmd={"SetEnv":{"StreamPublish":{"stMaster":{"wHostPort":1935,"bEnable":1,"nProtoType":3,"nChannel":0}}}}</code>	bEnable	0: off 1: on
Protol Type		nProtoType	2: srt 3: rtmp
Host Address	<code>http://192.168.5.126/ajaxcom?szCmd={"SetEnv":{"StreamPublish":{"stMaster":{"wHostPort":1935,"nProtoType":3,"szHostUrl":"192.168.5.12","nChannel":0}}}}</code>	szHostUrl	user-defined

Stream Publish			
Host Port	<code>http://192.168.5.126/ajaxcom?szCmd={"SetEnv":{"StreamPublish":{"stMaster":{"wHostPort":19355,"nProtoType":3,"nChannel":0}}}}</code>	wHostPort	[0,65535]
Stream Name	<code>http://192.168.5.126/ajaxcom?szCmd={"SetEnv":{"StreamPublish":{"stMaster":{"wHostPort":19355,"nProtoType":3,"szStreamName":"live/1213","nChannel":0}}}}</code>	szStreamName	user-defined
User Name	<code>http://192.168.5.126/ajaxcom?szCmd={"SetEnv":{"StreamPublish":{"stMaster":{"wHostPort":19355,"nProtoType":3,"szUserName":"123","nChannel":0}}}}</code>	szUserName	user-defined
Password	<code>http://192.168.5.126/ajaxcom?szCmd={"SetEnv":{"StreamPublish":{"stMaster":{"wHostPort":19355,"nProtoType":3,"szPassword":"123","nChannel":0}}}}</code>	szPassword	user-defined
SrtKey (SRT Effectie)	<code>http://192.168.5.126/ajaxcom?szCmd={"SetEnv":{"StreamPublish":{"stMaster":{"wHostPort":19355,"nProtoType":3,"szSrtKey":"0123456789","nChannel":0}}}}</code>	szSrtKey	user-defined
SrtKeyLen (SRTEffectie)	<code>http://192.168.5.126/ajaxcom?szCmd={"SetEnv":{"StreamPublish":{"stMaster":{"wHostPort":19355,"nProtoType":3,"wSrtKeyLen":0,"nChannel":0}}}}</code>	wSrtKeyLen	[0-32]

(RTP) Multicast Streaming

RTP Multicast	
Get rtp multicast parameters	
Code	<code>http://192.168.5.126/ajaxcom?szCmd={"GetEnv":{"StreamRTPMulticast":{"nChannel":-1}}}</code>
Set rtp multicast parameters	
Code	<code>http://192.168.5.126/ajaxcom?szCmd={"SetEnv":{"StreamRTPMulticast":{"stSlave":{"nProtoType":0,"bEnable":0,"wMultiCastPort":4002,"szMultiCastUrl":"224.1.2.3","stMaster":{"nProtoType":1,"bEnable":0,"wMultiCastPort":4000,"szMultiCastUrl":"224.1.2.3","nChannel":0}}}}</code>
NOTE: When modifying one param you should take along bEnable and awMultiCastPort. Otherwise, it will be set to 0. Suggesting that when setting env, you can distinguish the stMaster and stSlave.	

RTP Multicast Settings

RTP Multicast Settings			
Function	Code	Command	Setting
Enable	<code>http://192.168.5.126/ajaxcom?szCmd={"SetEnv":{"StreamRTPMulticast":{"stMaster":{"bEnable":1,"wMultiCastPort":4004,"nChannel":0}}}}</code>	bEnable	0: off 1: on
Protol Type	<code>http://192.168.5.126/ajaxcom?szCmd={"SetEnv":{"StreamRTPMulticast":{"stMaster":{"bEnable":1,"nProtoType":1,"wMultiCastPort":4004,"nChannel":0}}}}</code>	nProtoType	0: RTP 1: TS
Multicast Address	<code>http://192.168.5.126/ajaxcom?szCmd={"SetEnv":{"StreamRTPMulticast":{"stMaster":{"bEnable":0,"szMultiCastUrl":"224.1.2.23","wMultiCastPort":4004,"nChannel":0}}}}</code>	SzMultiCastUrl	224.0.0.0~ 255.255.255.0
Multicast Port	<code>http://192.168.5.126/ajaxcom?szCmd={"SetEnv":{"StreamRTPMulticast":{"stMaster":{"bEnable":1,"wMultiCastPort":4004,"nChannel":0}}}}</code>	wMultiCastPort	Even [0, 65535]

Camera Settings

Video Parameters			
Get video parameters			
Code	<code>http://192.168.5.126/ajaxcom?szCmd={"GetEnv":{"VideoParam":{"nChannel":-1}}}</code>		
Set video parameters			
Focus			
Function	Code	Command	Setting
Focus Mode	<code>http://192.168.5.126/ajaxcom?szCmd={"SetEnv":{"VideoParam":{"stAF":{"emAFMode":2,"nChannel":0}}}}</code>	emAFMode	2: Auto 3: Manual 4: OnePush

Video Parameters				
AF-Zone	http://192.168.5.126/ajaxcom?szCmd={"SetEnv":{"VideoParam":[{"stAF":{"emAFZone":1},"nChannel":0}]}}	emAFZone	0:	Front Focus
			1:	Back Focus
			2:	Meeting
			3:	Moving
			4:	Objects
			5:	Center Focus
AF-Sensitivity	http://192.168.5.126/ajaxcom?szCmd={"SetEnv":{"VideoParam":[{"stAF":{"nSensitivity":1},"nChannel":0}]}}	nSensitivity	1:	High
			2:	Middle
			3:	Low

Exposure

Camera Settings				
Exposure				
Mode	http://192.168.5.126/ajaxcom?szCmd={"SetEnv":{"VideoParam":[{"stExp":{"emExpMode":0},"nChannel":0}]}}	emExpMode	0:	Auto
			3:	Manual
			10:	SAE
			11:	AAE
			13:	Bright
Exposure: Auto				
EV	http://192.168.5.126/ajaxcom?szCmd={"SetEnv":{"VideoParam":[{"stExp":{"expcomp_mode":2},"nChannel":0}]}}	expcomp_mode	2:	ON
			3:	OFF
EV Level	http://192.168.5.126/ajaxcom?szCmd={"SetEnv":{"VideoParam":[{"stExp":{"expcomp":8},"nChannel":0}]}}	expcomp	[0, 14]	
BLC	http://192.168.5.126/ajaxcom?szCmd={"SetEnv":{"VideoParam":[{"stExp":{"backligh":2},"nChannel":0}]}}	backlight	2:	ON
			3:	OFF

Camera Settings				
Exposure: Auto				
Function	Code	Command	Setting	
Flicker	http://192.168.5.126/ajaxcom?szCmd={"SetEnv":{"VideoParam":[{"stExp":{"antiflicker":0},"nChannel":0}]}}	antiflicker	0:	OFF
			1:	50HZ
			2:	60HZ
G.Limit	http://192.168.5.126/ajaxcom?szCmd={"SetEnv":{"VideoParam":[{"stExp":{"gainLimit":5},"nChannel":0}]}}	gainLimit	[0, 15]	
DRC	http://192.168.5.126/ajaxcom?szCmd={"SetEnv":{"VideoParam":[{"stExp":{"drc":6},"nChannel":0}]}}	drc	[0, 8]	
Exposure: Manual				
shutter	http://192.168.5.126/ajaxcom?szCmd={"SetEnv":{"VideoParam":[{"stExp":{"stShutter":{"nShutter":16},"nChannel":0}]}}	nShutter	[0, 16]	
Iris	http://192.168.5.126/ajaxcom?szCmd={"SetEnv":{"VideoParam":[{"stExp":{"stIris":{"nIris":12},"nChannel":0}]}}	nIris	[0, 12]	
DRC	http://192.168.5.126/ajaxcom?szCmd={"SetEnv":{"VideoParam":[{"stExp":{"drc":8},"nChannel":0}]}}	drc	[0, 8]	
Exposure: SAE				
shutter	http://192.168.5.126/ajaxcom?szCmd={"SetEnv":{"VideoParam":[{"stExp":{"stShutter":{"nShutter":16},"nChannel":0}]}}	nShutter	[0, 16]	
DRC	http://192.168.5.126/ajaxcom?szCmd={"SetEnv":{"VideoParam":[{"stExp":{"drc":7},"nChannel":0}]}}	drc	[0, 8]	

Camera Settings				
Exposure: AEE				
Flicker	<code>http://192.168.5.126/ajaxcom?szCmd={"SetEnv":{"VideoParam":{"stExp":{"antiflicker":0},"nChannel":0}}}</code>	Antiflicker	0: 1: 2:	OFF 50HZ 60HZ
G.Limit	<code>http://192.168.5.126/ajaxcom?szCmd={"SetEnv":{"VideoParam":{"stExp":{"gainLimit":5},"nChannel":0}}}</code>	gainLimit	[0, 15]	
Iris	<code>http://192.168.5.126/ajaxcom?szCmd={"SetEnv":{"VideoParam":{"stExp":{"stIris":{"nlris":12},"nChannel":0}}}</code>	nlris	[0, 12]	
DRC	<code>http://192.168.5.126/ajaxcom?szCmd={"SetEnv":{"VideoParam":{"stExp":{"drc":6},"nChannel":0}}}</code>	drc	[0, 8]	
Exposure: Bright				
Bright	<code>http://192.168.5.126/ajaxcom?szCmd={"SetEnv":{"VideoParam":{"stExp":{"bright":0},"nChannel":0}}}</code>	bright	[0, 23]	
Flicker, G.Limit, DRC	You can find the same configure at AAE			

Color and Image

Camera Settings				
Color				
Function	Code	Command	Setting	
WB Mode	<code>http://192.168.5.126/ajaxcom?szCmd={"SetEnv":{"VideoParam":{"stColor":{"stWbMode":{"emWbMode":0},"nChannel":0}}}</code>	emWbMode	0: Auto 1: 3000K 7: 3500K 2: 4000K 8: 4500K 4: 5000K	9: 5500K 10: 6000K 6: 6500K 11: 7000K 5: Manual 3: OnePush
RG Tuning	<code>http://192.168.5.126/ajaxcom?szCmd={"SetEnv":{"VideoParam":{"stColor":{"rgaintuning":0},"nChannel":0}}}</code>	rgaintuning	[0, 20]	
BG Tuning	<code>http://192.168.5.126/ajaxcom?szCmd={"SetEnv":{"VideoParam":{"stColor":{"bgaintuning":20},"nChannel":0}}}</code>	bgaintuning	[0, 20]	
Saturation	<code>http://192.168.5.126/ajaxcom?szCmd={"SetEnv":{"VideoParam":{"stColor":{"saturation":0},"nChannel":0}}}</code>	saturation	[0, 14]	
Hue	<code>http://192.168.5.126/ajaxcom?szCmd={"SetEnv":{"VideoParam":{"stColor":{"hue":14},"nChannel":0}}}</code>	hue	[0, 14]	
AWB Sensitivity	<code>http://192.168.5.126/ajaxcom?szCmd={"SetEnv":{"VideoParam":{"stColor":{"awbsens":0},"nChannel":0}}}</code>	awbsens	0: 1: 2:	Low Middle High
Image				
Bright	<code>http://192.168.5.126/ajaxcom?szCmd={"SetEnv":{"VideoParam":{"stImg":{"luminance":0},"nChannel":0}}}</code>	luminance	[0, 4]	
Contrast	<code>http://192.168.5.126/ajaxcom?szCmd={"SetEnv":{"VideoParam":{"stImg":{"contrast":0},"nChannel":0}}}</code>	contrast	[0, 14]	
Sharpness	<code>http://192.168.5.126/ajaxcom?szCmd={"SetEnv":{"VideoParam":{"stImg":{"sharpness":1},"nChannel":0}}}</code>	sharpness	[0, 15]	
Gamma	<code>http://192.168.5.126/ajaxcom?szCmd={"SetEnv":{"VideoParam":{"stImg":{"gamma":0},"nChannel":0}}}</code>	gamma	[0, 4]	0: Default 1: 0.45 2: 0.50 3: 0.55 4: 0.63
DCI	<code>http://192.168.5.126/ajaxcom?szCmd={"SetEnv":{"VideoParam":{"stImg":{"dci":0},"nChannel":0}}}</code>	dci	[0, 8] 0:	OFF

Camera Settings				
B&W Mode	<code>http://192.168.5.126/ajaxcom?szCmd={"SetEnv":{"VideoParam":{"stImg":{"nBWMMode":0},"nChannel":0}}}</code>	nBWMMode	0: 4:	Color B & W
Flip-H	<code>http://192.168.5.126/ajaxcom?szCmd={"SetEnv":{"VideoParam":{"stImg":{"nFlipH":3},"nChannel":0}}}</code>	nFlipH	2: 3:	ON OFF

Camera Settings				
Image				
Function	Code	Command	Setting	
Flip-V	<code>http://192.168.5.126/ajaxcom?szCmd={"SetEnv":{"VideoParam":{"stImg":{"nFlipV":2},"nChannel":0}}}</code>	nFlipV	2: 3:	ON OFF
AutoFlip	<code>http://192.168.5.126/ajaxcom?szCmd={"SetEnv":{"VideoParam":{"stImg":{"nAutoFlipV":2},"nChannel":0}}}</code>	nAutoFlipV		ON OFF
DZoom	<code>http://192.168.5.126/ajaxcom?szCmd={"SetEnv":{"VideoParam":{"stImg":{"nEZoom":3},"nChannel":0}}}</code>	nEZoom	2: 3:	ON OFF

Noise Reduction

Camera Settings				
Function	Code	Command	Setting	
NR-2D	<code>http://192.168.5.126/ajaxcom?szCmd={"SetEnv":{"VideoParam":{"stNR":{"noise2D":0},"nChannel":0}}}</code>	noise2D	[0, 8]	
NR-3D	<code>http://192.168.5.126/ajaxcom?szCmd={"SetEnv":{"VideoParam":{"stNR":{"noise3D":0},"nChannel":0}}}</code>	noise3D	[0, 8]	0: OFF 8: Auto
Dynamic Hot Pixel	<code>http://192.168.5.126/ajaxcom?szCmd={"SetEnv":{"VideoParam":{"stNR":{"dhotpixel":3},"nChannel":0}}}</code>	dhotpixel	[0, 5]	0: OFF
Style	<code>http://192.168.5.126/ajaxcom?szCmd={"SetEnv":{"VideoParam":{"stColor":{"nStyleInx":0},"nChannel":0}}}</code>	nStyleInx	[0, 4]	0: Default 1: Normal 2: Clarity 3: Bright 4: Soft

Video OSD

Video OSD	
Get video parameters	
Code	<code>http://192.168.5.126/ajaxcom?szCmd={"GetEnv":{"VideoOsd":{"nChannel":-1}}}</code>
Set set video parameters	
Code	<code>http://192.168.5.126/ajaxcom?szCmd={"SetEnv":{"VideoOsd":{"stTime":{"bEnable":1,"nIndex":0,"nXPos":0,"szText":"","nYPos":10000,"stFtColor":{"byAlpha":128,"byRed":255,"byGreen":255,"byBlue":255},"stBkColor":{"byAlpha":0,"byRed":0,"byGreen":0,"byBlue":0},"stTitle":{"bEnable":0,"nIndex":0,"nXPos":0,"szText":"","nYPos":0,"stFtColor":{"byAlpha":128,"byRed":255,"byGreen":255,"byBlue":255},"stBkColor":{"byAlpha":0,"byRed":0,"byGreen":0,"byBlue":0},"nChannel":0}}}}</code>
NOTE: All params can be saved by this command and also you can set one param alone.	

Function	Code	Command	Setting
Show Time	<code>http://192.168.5.126/ajaxcom?szCmd={"SetEnv":{"VideoOsd":{"stTime":{"bEnable":1},"nChannel":0}}}</code>	bEnable	0: Not show 1: Show
Show Title	<code>http://192.168.5.126/ajaxcom?szCmd={"SetEnv":{"VideoOsd":{"stTitle":{"bEnable":1},"nChannel":0}}}</code>	bEnable	0: Not Show 1: Show

Video OSD			
Set video parameters			
Function	Code	Command	Setting

Video OSD			
Time FontColor	http://192.168.5.126/ajaxcom?szCmd={"SetEnv":{"VideoOsd":{"stTime":{"stFtColor":{"byAlpha":128,"byRed":255,"byGreen":255,"byBlue":0},"nChannel":0}}}}	byAlpha	128
		white	rgb (255,255,255)
		black	rgb (0,0,0)
		yellow	rgb (255,255,0)
		red	rgb (255,0,0)
		blue	rgb (0,0,255)
Title FontColor	http://192.168.5.126/ajaxcom?szCmd={"SetEnv":{"VideoOsd":{"stTitle":{"stFtColor":{"byAlpha":128,"byRed":255,"byGreen":255,"byBlue":0},"nChannel":0}}}}	byAlpha	128
		white	rgb (255,255,255)
		black	rgb (0,0,0)
		yellow	rgb (255,255,0)
		red	rgb (255,0,0)
		blue	rgb (0,0,255)
OSD Offsetx pos	Time: http://192.168.5.126/ajaxcom?szCmd={"SetEnv":{"VideoOsd":{"stTime":{"nXPos":9200,"nChannel":0}}}}	nXPos	[0, 10000]
OSD Offsetx pos	Title: http://192.168.5.126/ajaxcom?szCmd={"SetEnv":{"VideoOsd":{"stTitle":{"nXPos":9200,"nChannel":0}}}}	nXPos	[0, 10000]
OSD Offsety pos	Time: http://192.168.5.126/ajaxcom?szCmd={"SetEnv":{"VideoOsd":{"stTime":{"nYPos":1200,"nChannel":0}}}}	nYPos	[0, 10000]
	Title: http://192.168.5.126/ajaxcom?szCmd={"SetEnv":{"VideoOsd":{"stTitle":{"nYPos":1200,"nChannel":0}}}}		

OSD Font Size			
Get OSD font size parameters			
Code	http://192.168.5.126/ajaxcom?szCmd={"GetEnv":{"TTFtFontSize":{"nChannel":-1}}}		
Set video parameters			
Code	http://192.168.5.126/ajaxcom?szCmd={"SetEnv":{"TTFtFontSize":{"nFontSize":[48,48],"bAutoSize":1}}}		
Function	Code	Command	Setting
		bAutoSize	0: off, 1: on
		nFontSize	[8,200]

Output Format

(Video) Output Format			
Get video out parameters			
Code	http://192.168.5.126/ajaxcom?szCmd={"GetEnv":{"VideoOut":{"nChannel":-1}}}		
Set video out parameters			
Code	http://192.168.5.126/ajaxcom?szCmd={"SetEnv":{"VideoOut":{"nNetMode":2,"emVoutFormat":9,"byFormatList":[10,9,4,3,8,7,6,5,26,25,20,21,22,23,24]}}}		
Function	Code	Command	Setting
		nNetMode: default value 2, do not modify it	<ul style="list-style-type: none"> - HD output - HD output + SD network - SD output + HD network

(Video) Output Format				
		emVoutFormat: Setting the current video out format.	10: 9: 4: 3:	1080P60 1080P50 1080P30 1080P25
			8:	1080i60
			7:	1080i50
			6:	720P60
			5:	720P50
			26:	720P30
			25:	720P25
			20:	1080P59.94
			21:	1080i59.94
			22:	1080P29.97
			23:	720P59.94
			24:	720P29.97

SRT

SRT			
Get network SRT parameters			
Code	<code>http://192.168.5.126/ajaxcom?szCmd={"GetEnv":{"NetWork":{"nChannel":-1}}}</code>		
Set network SRT parameters			
Code	<code>http://192.168.5.126/ajaxcom?szCmd={"SetEnv":{"NetWork":{"stSrt":{"wSrtLen":0,"wSrtPort":9000,"szSrtPin":"xxxxxxxxx"}}}}</code>		
Function	Code	Command	Setting
crypto key length in bytes		wSrtLen	[0-32]
Port SRT		wSrtPort	Default 9000
Password stream encryption		szSrtPin	user-defined

Network

Network configure and port settings

Network Configure			
Get network port parameters			
Code	<code>http://192.168.5.126/ajaxcom?szCmd={"GetEnv":{"NetWork":{"nChannel":-1}}}</code>		
Set network port parameters			
Code	<code>http://192.168.5.126/ajaxcom?szCmd={"SetEnv":{"NetWork":{"stNetPort":{"wPortSoap":1936,"wPortData":3000,"wPortWeb":80,"wPortRtsp":554,"wPortVisca":1259,"wPortOnvif":2000,"wPortRtmp":1935}}}}</code>		
	You can also set one of these parameters like this: <code>http://192.168.5.126/ajaxcom?szCmd={"SetEnv":{"NetWork":{"stNetPort":{"wPortSoap":1936}}}}</code>		
Port Settings			
Function	Code	Command	Setting
Port Data		wPortData	[0, 65535]

Network Configure			
Port Web		wPortWeb	[0, 65535]
Port Onvif		wPortOnvif	[0, 65535]
Port Soap		wPortSoap	[0, 65535]
Port Rtmp		wPortRtmp	[0, 65535]
Port Rtsp		wPortRtsp	[0, 65535]
Port Visca		wPortVisca	[0, 65535]

Ethernet

Ethernet			
Get Ethernet parameters			
Code	http://192.168.5.126/ajaxcom?szCmd={"GetEnv":{"NetWork":{"nChannel":-1}}}		
Set Ethernet parameters			
Code	http://192.168.5.126/ajaxcom?szCmd={"SetEnv":{"NetWork":{"stEth":{"byValid":5,"szIPAddr":"192.168.5.126","szSubMask":"255.255.255.0","szMacAddr":"E4:77:D4:01:8A:49","szGateway":"192.168.5.1","bDefault":1}}}}		
Function	Code	Command	Setting
DHCP	http://192.168.5.126/ajaxcom?szCmd={"SetEnv":{"NetWork":{"stEth":{"byValid":5}}}}	byValid	5:off 7:on
IP Address	http://192.168.5.126/ajaxcom?szCmd={"SetEnv":{"NetWork":{"stEth":{"szIPAddr":"192.168.5.127"}}}}		
Subnet Mask	http://192.168.5.126/ajaxcom?szCmd={"SetEnv":{"NetWork":{"stEth":{"szSubMask":"255.255.255.0"}}}}		
Default Gateway	http://192.168.5.126/ajaxcom?szCmd={"SetEnv":{"NetWork":{"stEth":{"szGateway":"192.168.5.1"}}}}		

DNS

DNS			
Get dns parameters			
Code	http://192.168.5.126/ajaxcom?szCmd={"GetEnv":{"NetWork":{"nChannel":-1}}}		
Set dns parameters			
Code	http://192.168.5.126/ajaxcom?szCmd={"SetEnv":{"NetWork":{"stDns":{"szDns1":"8.8.8.8","szDns2":"0.0.0.0"}}}}		
Function	Code	Command	Setting
Preferred DNS Server	http://192.168.5.126/ajaxcom?szCmd={"SetEnv":{"NetWork":{"stDns":{"szDns1":"8.8.8.8"}}}}		
Alternative DNS Server	http://192.168.5.126/ajaxcom?szCmd={"SetEnv":{"NetWork":{"stDns":{"szDns2":"8.8.8.8"}}}}		

System

System Configure			
Get sysattr parameters			
Code	http://192.168.5.126/ajaxcom?szCmd={"GetEnv":{"SysAttr":{"nChannel":-1}}}		
Set sysattr parameters			
Code	http://192.168.5.126/ajaxcom?szCmd={"SetEnv":{"SysAttr":{"nLanguage":0,"szDeviceID":"1","emVideoStandard":1,"szDevName":"testname"}}}		
Function	Code	Command	Setting
Device Name		szDevName	user-defined, cannot use white space
Device ID		szDeviceID	cannot modify
Language		nLanguage	0: Simplified Chinese 2: English

License

License	
Get License parameters	
Code	http://192.168.5.126/ajaxcom?szCmd={"QueryState":{"QueryLicenseState":{}}}
Set License parameters	
Code	http://192.168.5.126/ajaxcom?szCmd={"SetEnv":{"LicenseKey":{"bLicenseEnable":0,"szKeyText":"483B4EB1D0"}}}

Time

SysTime	
Get system time parameters	
Code	http://192.168.5.126/ajaxcom?szCmd={"QueryState":{"QuerySysTime":{}}}
Set system time parameters	
Code	http://192.168.5.126/ajaxcom?szCmd={"SetEnv":{"SysTime":{"nDateSprtr":2,"nDateFormat":0,"nZone":1,"nHourType":0,"stNtp":{"bEnable":1,"nHostPort":123,"nUpdateInterval":2,"szHostUrl":"ntp4.aliyun.com"}}}}

Function	Code	Command	Setting
Date Format	http://192.168.5.126/ajaxcom?szCmd={"SetEnv":{"SysTime":{"nDateFormat":0}}}	nDateFormat	0: YYYY-MM-DD 1: MM-DD-YYYY 2: DD-MM-YYYY
Date Sprtr	http://192.168.5.126/ajaxcom?szCmd={"SetEnv":{"SysTime":{"nDateSprtr":0}}}	nDateSprtr	0: . 1: - 2: /

SysTime			
Function	Code	Command	Setting
Zone	http://192.168.5.126/ajaxcom?szCmd={"SetEnv":{"SysTime":{"nZone":0}}}	nZone	[0, 32] 0: GMT 1: GMT+01:00 2: GMT+02:00 3: GMT+03:00 4: GMT+03:30 5: GMT+04:00 6: GMT+04:30 7: GMT+05:00 13: GMT+08:00 20: GMT-01:00 31: GMT-11:00 32: GMT-12:00

SysTime			
Function	Code	Command	Setting
Hour Type	http://192.168.5.126/ajaxcom?szCmd={"SetEnv":{"SysTime":{"nHourType":0}}}	nHourType	0: 24 Hours 1: 12 Hours
NTP Enable	http://192.168.5.126/ajaxcom?szCmd={"SetEnv":{"SysTime":{"stNtp":{"bEnable":1}}}}	bEnable	0: off 1: on
Update Interval	http://192.168.5.126/ajaxcom?szCmd={"SetEnv":{"SysTime":{"stNtp":{"nUpdateInterval":2}}}}	nUpdateInterval	[1, 10]
Host URL	http://192.168.5.126/ajaxcom?szCmd={"SetEnv":{"SysTime":{"stNtp":{"szHostUrl":"time.nist.gov"}}}}	szHostUrl	user-defined, ntp server address
Host Port	http://192.168.5.126/ajaxcom?szCmd={"SetEnv":{"SysTime":{"stNtp":{"nHostPort":123}}}}	nHostPort	user-defined: [0, 65535]
Time Settings	http://192.168.5.126/ajaxcom?szCmd={"SysCtrl":{"SetTime":{"bTimeType":1,"nZone":19,"stDateTime":{"dwYear":2018,"byHour":15,"byMinute":38,"byDay":1,"byMonth":11,"bySecond":2}}}}		Synchronize with computer time or set manual:
Synchronize NTP Server	http://192.168.5.126/ajaxcom?szCmd={"SysCtrl":{"SyncNtp":""}}		

User

SysUser			
Get sysuser parameters			
Code	http://192.168.5.126/ajaxcom?szCmd={"GetEnv":{"SysUser":{}}}		
Set sysuser parameters			
Code	http://192.168.5.126/ajaxcom?szCmd={"SetEnv":{"SysUser":{"stUsers":[{"nUserType":0,"szUserName":"admin","szPassword":"admin"}, {"nUserType":1,"szUserName":"user1","szPassword":"user1"}, {"nUserType":1,"szUserName":"user2","szPassword":"user2"}]}}		
Function	Code	Command	Setting
Authority		nUserType	0: admin 1: user1 or user 2
User Name		szUserName	user-defined: no white space
Password		szPassword	user-defined, no white space. This command must set three users at the same time.

Update

Update	
Get update parameters	
Code	http://192.168.5.126/ajaxcom?szCmd={"QueryState":{"QueryVersion":{}}}
Code	Get the return value and split it like this: szText.Format("%d.%d.%d-%d-%d", (stVersion.dwCamVersion>>16)&0xFF, (stVersion.dwCamVersion>>8)&0xFF, (stVersion.dwCamVersion0xFF), (stVersion.dwCamDate>>16)&0xFFFF, (stVersion.dwCamDate>>8)&0xFF, (stVersion.dwCamDate&0xFF));
Set update parameters	Not supported update with API, you can do this through webpage.

Default and Reboot

Default	
Code	http://192.168.5.126/ajaxcom?szCmd={"SysCtrl":{"Default":{}}}
Reboot	
Code	http://192.168.5.126/ajaxcom?szCmd={"SysCtrl":{"Reboot":{}}}



The URL supports to set all params at one time and also can set one of them by splitting URL into one other command. Different commands can be found at different settings.

APPENDIX D - CMOS SENSOR CHARACTERISTICS

The following occurrences that may appear in images are specific to CMOS (Complementary Metal Oxide Semiconductor) image sensors. They do not indicate malfunctions.

White Flecks

Although the CMOS image sensors are produced with high-precision technologies, fine white flecks may be generated on the screen in rare cases. These flecks are caused by natural and / or artificial radiation, which causes a “false exposure” on the image sensor. The shape of these spots may vary from dots to lines or other —sometimes irregular— shapes. These spots occur in random locations of the image, occur only in a single frame and are more visible in dark images. This is a principle issue of all image sensors and **is not a malfunction**.

The white flecks especially tend to be seen in the following cases:

- When operating at a high ambient temperature
- When you have raised the gain (sensitivity)

The white flecks may be reduced by turning the camera off, then on again.

Aliasing

When fine patterns, stripes, or lines are shot, they may appear jagged or flickering. **Aliasing** refers to the effect that is produced when a signal is imperfectly reconstructed from the original signal. It occurs when a signal is not sampled at a high enough frequency to create an accurate representation.

This effect is shown in the following example of a **sinusoidal function**:

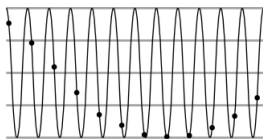

In this example, the dots represent the sampled data and the curve represents the original signal. Because there are not enough sampled data points, the resulting pattern produced by the sampled data is a poor representation of the original.

Focal Plane

Owing to the characteristics of the pickup elements (CMOS image sensors) for reading video signals, subjects that quickly move across the screen may appear slightly skewed (i.e., tilted to the left or right, depending on the direction of camera or subject movement). Since a CMOS sensor typically captures one row at a time within approximately 1/60th or 1/50th of a second (depending on the refresh rate), it may result in a “rolling shutter” effect. In such cases, the image is skewed.

Flash Band

If you film a strobe or quick-flashing light, brightness may differ between the upper and lower halves of the picture. See the Focal Plane explanation above for a clarification of this occurrence.

Flicker

If you are recording under lighting that is produced by discharge tubes (such as fluorescent, sodium or mercury-vapor lamps), the screen may flicker, colors may vary, or horizontal stripes may appear distorted. In such cases, set the anti-flicker setting to 'on'. Depending on lighting types, such occurrences may not be improved with the anti-flicker setting.



It is recommended to set the shutter speed to 1/100s in areas of 50 Hz power supply frequency, and to 1/60s in areas of 60 Hz power supply frequency.

APPENDIX E - DATASHEET (SPECIFICATIONS)

SPECIFICATIONS CM70-IP

Camera

Resolution	Up to 1080p60
Video Systems	1920x1080/ 1280x720 p60/ 50/ 30/ 25/ 59.94/ 29.97
Sensor	1/3" CMOS, 2.12mp, 16:9
Shutter	Auto, Manual, 1/25 ~ 1/10000
Scanning mode	Progressive, Interlaced (not over IP)
Zoom/Aperture/Focal length	20x optical/ F1.8-F11/ 4.4-88.8 mm
Minimal Illumination	0.05 LUX
White Balance	Auto, Manual, OnePush, 2400K-7100K in steps of 100K
Backlight Compensation	supported
Digital Noise Reduction	2D & 3D DNR
Signal Noise Ratio	>55 dB
Horizontal FOV wide ~ tele	60.38° ~ 3.72°
Vertical FOV wide ~tele	35.80° ~ 2.14°
Horizontal rotation	-170° ~ +170°
Vertical rotation	-30° ~ +90°
Pan speed range	1.7 ~ 120°/s
Tilt speed range	1.7 ~ 70°/s
H&V image flip	supported
Number of presets	255
Preset accuracy	0.1

IP features

Video coding standard	H.265 / H.264 / MJPEG
H.265 Profiles	main
H.264 Profiles	main, base high
Main stream resolution	1920x1080 / 1280x720
Main stream max frame rate	60fps
Main stream bitrate	64 ~ 40960 Kbps
Sub stream resolution	320x180 / 320x240 / 640x360 / 1280x720 / 1920x1080
Sub stream max frame rate	30fps
Sub stream bitrate	64 ~ 40960 Kbps
Video bitrate type	Variable, Fixed
Support protocols	RTSP, RTMP, ONVIF, SRT, Multicast, Unicast
Audio standard	AAC / mp3 / G.711A
Audio bitrate	32, 64, 96, 128 Kbps
Audio sample rate	16, 32, 44.1, 48 KHz
Audio line in	balanced audio line in via 5-way Phoenix connector.

Input / Output Interface

HDMI output	1.4
SDI output	3G-SDI, SMPTE 425M level A, 10-bit YCbCr 4:2:2
USB Output	USB 2.0 (max. 1080p30)
Network interface	RJ45 100 Mbit
Control	UVC, IR Remote, IP, Serial
Serial communication	RS232 mini DIN-8, RS485 2pin Phoenix
Serial control protocol	VISCA over Serial, PELCO-P, PELCO-D
IP control protocol	VISCA OVER IP, ONVIF, HTTP API

General Specifications

Input voltage	12V
PoE	PoE 12W (802.3af)
Power consumption	12W
Power supply	12V2A
Power connector	EIAJ-4 - Philmore 255 plug
Operating temperature	-5°C ~ 40°C
Storage temperature	-20°C ~ 60°C
Operating humidity	20% ~ 95% non-condensing
Bottom fastening screw thread	1/4" 20 UNC
Color	Black, White
Dimensions product wxhxd	133 x 180 x 153 mm excl. connectors
Weight product	1,6 kgs
Dimensions box	26 x 24 x 24 cm
Weight box	2,4 kg
Included	power adapter, remote control, RS232 cable, RS485 2-way Phoenix connector, Balanced Audio, Line-In 5-way Phoenix connector

Versions

Black	CM70-IP-B
White	CM70-IP-W

Compliance

Markings	CE, FCC, cULus
Medical	EN-IEC 60601-1-2 (2015) certified (class A, home- and professional healthcare environment)

SPECIFICATIONS CM71-IP

Camera

Resolution	Up to 1080p60
Video Systems	1920x1080/1280x720 p60/ 50/ 30/ 25/ 59.94/ 29.97
Sensor	1/3" CMOS, 2.12mp, 1.6:9
Shutter	Auto, Manual, 1/25 ~ 1/10000
Scanning mode	Progressive, Interlaced (not over IP)
Zoom/Aperture/Focal length	12x optical/ F1.8-F11/ 3.9-46.8 mm
Minimal Illumination	0.05 LUX
White Balance	Auto, Manual, OnePush, 2400K-7100K in steps of 100K
Backlight Compensation	supported
Digital Noise Reduction	2D & 3D DNR
Signal Noise Ratio	>55 dB
Horizontal FOV wide ~ tele	70.4° ~ 6.6°
Vertical FOV wide ~tele	42.4° ~ 3.7°
Horizontal rotation	-170° ~ +170°
Vertical rotation	-30° ~ +90°
Pan speed range	1.7 ~ 120°/s
Tilt speed range	1.7 ~ 70°/s
H&V image flip	supported
Number of presets	255
Preset accuracy	0.1

IP features

Video coding standard	H.265 / H.264 / MJPEG
H.265 Profiles	main
H.264 Profiles	main, base, high
Main stream resolution	1920x1080 / 1280x720
Main stream max frame rate	60fps
Main stream bitrate	64 ~ 40960 Kbps
Sub stream resolution	320x180 / 320x240 / 640x360 / 1280x720 / 1920x1080
Sub stream max frame rate	30fps
Sub stream bitrate	64 ~ 40960 Kbps
Video bitrate type	Variable, Fixed
Support protocols	RTSP, RTMP, ONVIF, SRT, Multicast, Unicast
Audio standard	AAC / mp3 / G.711A
Audio bitrate	32, 64, 96, 128 Kbps
Audio sample rate	16, 32, 44.1, 48 Khz
Audio line in	balanced audio line in via 5-way Phoenix connector.

Input / Output Interface

HDMI output	1.4
SDI output	3G-SDI, SMPTE 425M level A, 10-bit YCbCr 4:2:2
USB Output	USB 2.0 (max. 1080p30)
Network interface	RJ45 100 Mbit
Control	UVC, IR Remote, IP, Serial
Serial communication	RS232 mini DIN-8, RS485 2pin Phoenix
Serial control protocol	VISCA over Serial, PELCO-P, PELCO-D
IP control protocol	VISCA OVER IP, ONVIF, HTTP API

General Specifications

Input voltage	12V
PoE	PoE 12W (802.3af)
Power consumption	12W
Power supply	12V2A
Power connector	EIAJ-4 - Philmore 255 plug
Operating temperature	-5°C ~ 40°C
Storage temperature	-20°C ~ 60°C
Operating humidity	20% ~ 95% non-condensing
Bottom fastening screw thread	1/4" 20 UNC
Color	White
Dimensions product wxhxd	133 x 180 x 153 mm excl. connectors
Weight product	1.6 kgs
Dimensions box	26 x 24 x 24 cm
Weight box	2.5 kg
Included	power adapter, remote control, RS232 cable, RS485 2-way Phoenix connector, Balanced Audio Line-In 5-way Phoenix connector

Versions

White	CM71-IP-W
-------	-----------

Compliance

Markings	CE, FCC, cULus
Medical	EN-IEC 60601-1-2 (2015) certified (class A, home- and professional healthcare environment)

SPECIFICATIONS CM73-IP

Camera

Resolution	Up to 1080p60
Video Systems	1920x1080/1280x720 p60/ 50/ 30/ 25/ 59.94/ 29.97
Sensor	1/3" CMOS, 2.12mp, 1.6:9
Shutter	Auto, Manual, 1/25 ~ 1/10000
Scanning mode	Progressive, Interlaced (not over IP)
Zoom/Aperture/Focal length	30x optical/ F1.8-F11/ 4.3-129.0 mm
Minimal Illumination	0.05 LUX
White Balance	Auto, Manual, OnePush, 2400K-7100K in steps of 100K
Backlight Compensation	supported
Digital Noise Reduction	2D & 3D DNR
Signal Noise Ratio	>55 dB
Horizontal FOV wide ~ tele	64.14° ~ 2.55°
Vertical FOV wide ~tele	38.01° ~ 1.48°
Horizontal rotation	-170° ~ +170°
Vertical rotation	-30° ~ +90°
Pan speed range	1.7 ~ 120°/s
Tilt speed range	1.7 ~ 70°/s
H&V image flip	supported
Number of presets	255
Preset accuracy	0.1

IP features

Video coding standard	H.265 / H.264 / MJPEG
H.265 Profiles	main
H.264 Profiles	main, base, high
Main stream resolution	1920x1080 / 1280x720
Main stream max frame rate	60fps
Main stream bitrate	64 ~ 40960 Kbps
Sub stream resolution	320x180 / 320x240 / 640x360 / 1280x720 / 1920x1080
Sub stream max frame rate	30fps
Sub stream bitrate	64 ~ 40960 Kbps
Video bitrate type	Variable, Fixed
Support protocols	RTSP, RTMP, ONVIF, SRT, Multicast, Unicast
Audio standard	AAC / mp3 / G.711A
Audio bitrate	32, 64, 96, 128 Kbps
Audio sample rate	16, 32, 44.1, 48 Khz
Audio line in	balanced audio line in via 5-way Phoenix connector.

Input / Output Interface

HDMI output	1.4
SDI output	3G-SDI, SMPTE 425M level A, 10-bit YCbCr 4:2:2
USB Output	USB 2.0 (max. 1080p30)
Network interface	RJ45 100 Mbit
Control	UVC, IR Remote, IP, Serial
Serial communication	RS232 mini DIN-8, RS485 2pin Phoenix
Serial control protocol	VISCA over Serial, PELCO-P, PELCO-D
IP control protocol	VISCA OVER IP, ONVIF, HTTP API

General Specifications

Input voltage	12V
PoE	PoE 12W (802.3af)
Power consumption	12W
Power supply	12V2A
Power connector	EIAJ-4 - Philmore 255 plug
Operating temperature	-5°C ~ 40°C
Storage temperature	-20°C ~ 60°C
Operating humidity	20% ~ 95% non-condensing
Bottom fastening screw thread	1/4" 20 UNC
Color	Black, White
Dimensions product wxhxd	133 x 180 x 153 mm. excl. connectors
Weight product	1.6 kgs
Dimensions box	26 x 24 x 24 cm
Weight box	2.4 kg
Included	power adapter, remote control, RS232 cable, RS485 2-way Phoenix connector, Balanced Audio Line-In 5-way Phoenix connector
Versions	
Black	CM73-IP-B
White	CM73-IP-W

Compliance

Markings	CE, FCC, cULus
Medical	EN-IEC 60601-1-2 (2015) certified (class A, home- and professional healthcare environment)

APPENDIX F - LIST OF SUPPORT ARTICLES

Settings

- [Anti flickering](#)
- [CM40 & CM70 series network setup guide](#)
- [CM7x IP main and sub streams](#)
- [Do I need an additional license to enable NDI on my CM70 series camera?](#)
- [How to set, call and clear presets in the camera web GUI](#)
- [How can I open the OSD menu of my camera?](#)
- [How to use the Select Switch / Rotary dial?](#)
- [How to give a DHCP IP address to a CM4x/CM7x camera?](#)
- [How to give a static IP Address to a CM4x/CM7x camera?](#)
- [Live Preview solutions](#)
- [MJPEG Snapshot](#)
- [Quick CM7x onsite setup for a local IP stream](#)

Maintenance

- [How to update a CM40 or CM70 series came](#)
- [How can I reset my CM4x/CM7x camera from the web GUI?](#)
- [How to register a license in a CM7x series](#)
- [How can I reset my CM4x/CM7x camera with an IR remote control?](#)
- [How to reset the IP configuration in a CM4x/CM7x camera?](#)
- [HTTP Basic Authentication \(BA\)](#)
- [Where to find the correct firmware for my camera?](#)

Troubleshooting

- [AUTOFLIP, FLIP-H, FLIP-V functions](#)
- [How do I change the HDMI or SDI output resolution of my camera?](#)
- [How do I know the IP address assigned to my camera?](#)
- [Latency introduction](#)
- [Why doesn't my CM70 series camera respond to the power on command over IP?](#)
- [Why is my camera out-of-focus?](#)

Audio

- [Audio support in Avonic cameras](#)
- [Balanced Audio Connection in CM7x](#)
- [Embedded audio and CM7x USB video output](#)
- [How to set the audio delay in a CM7x?](#)

Control

- [Camera control solutions](#)
- [Good practice externally controlling Avonic cameras using conference software](#)
- [How to use the CM70 series HTTP API](#)
- [How to control the Tally light on a CM70-series camera?](#)
- [How to open the camera's web GUI?](#)
- [Is it possible to control the PTZ speed when recalling a preset?](#)
- [What settings are stored in Avonic camera presets?](#)
- [What ONVIF version and profile are used by Avonic?](#)

Streaming

- [CM40 or CM70 series Streaming to YouTube](#)
- [SRT Streaming with CM70 series camera](#)
- [Which Protocol should I use to stream my video?](#)

Quick Start Guides

- [Are all the camera outputs simultaneous?](#)
- [CM4x/CM70 series IR remote Shortcuts](#)
- [CM4x/CM7x IR remote control buttons](#)
- [CM40 & CM70 series Camera Quick-start Guide](#)
- [Camera mount solutions](#)
- [Quick CM7x onsite setup with an IR Remote Control](#)

Technical Background

- [CCM - Customizable Color Matrix](#)
- [General camera recommendations and settings](#)
- [HDMI - High-Definition Multimedia Interface](#)
- [MJPEG, H.264 or H.265 codec?](#)
- [Output framerate vs. sensor exposure time](#)
- [SRT - Secure, Reliable Transport](#)
- [SDI - Serial digital interface](#)
- [Unicast, Multicast and Broadcast](#)
- [USB - Universal Serial Bus](#)

Index

A

AAE Mode (Aperture Auto Exposure) [32](#), [83](#)
AF Sensitivity [29](#), [53](#), [68](#), [82](#)
AF Version [43](#), [54](#), [89](#)
AF Zone [29](#), [53](#), [68](#), [82](#)
Audio [25](#), [78](#)
Auto Exposure Mode [30](#)
AWB Mode [52](#)
AWB Sensitivity [33](#), [52](#), [68](#), [83](#)

B

Balanced Audio [16](#)
Baudrate [17](#), [44](#), [51](#)
BG Tuning [33](#), [52](#), [59](#), [66](#), [69](#), [83](#)
BLC (Back Light Compensation) [30](#), [48](#), [52](#), [66](#), [82](#)
Bright [34](#), [66](#)
Bright (Exposure) Mode [33](#), [83](#)
BW (Black and White) Mode [34](#), [52](#), [84](#)

C

Camera Version [43](#), [54](#), [89](#)
CAT [16](#)
CBR [26](#)
CCM (Customizable Color Matrix) [35](#)
Ceiling Mount (AV-MT250) [15](#)
CMOS [90](#)
Color [23](#), [24](#), [33](#), [52](#), [59](#), [83](#)
COM port [17](#)
Contrast [34](#), [68](#), [83](#)
Controller [17](#), [17](#), [18](#), [50](#)

D

DC12V [15](#)
DCI (Dynamic Contrast) [34](#), [52](#), [83](#)
Device ID [41](#), [87](#)
Device Name [41](#), [87](#)
DHCP [20](#), [54](#), [87](#)
DNS Server [41](#), [87](#)
DRC (Dynamic Range Compression) [30](#), [31](#), [52](#), [82](#)
Dynamic Hot Pixel [34](#), [53](#), [67](#), [84](#)

E

Ethernet [40](#), [87](#)
EV (Exposure Value) [30](#), [52](#)
EV (level) [66](#), [82](#)
Export Configuration [44](#)
Exposure [23](#), [24](#), [30](#), [52](#), [59](#), [66](#), [82](#)

F

Factory Reset [43](#), [54](#), [68](#), [89](#)
Firmware [43](#), [54](#), [60](#), [68](#), [89](#)
Flicker [30](#), [59](#), [67](#), [82](#), [90](#)
Flip-H, Flip-V, Autoflip [34](#), [52](#), [67](#), [68](#), [84](#)
Focus [22](#), [24](#), [29](#), [29](#), [47](#), [53](#), [59](#), [65](#), [78](#), [81](#)

G

G.Limit (Gain Limit) [30](#), [52](#), [66](#), [82](#)
Gamma [34](#), [52](#), [83](#)

H

H264 [21](#), [26](#), [28](#), [38](#)
H265 [26](#)
HDMI [15](#), [17](#), [17](#), [39](#), [48](#), [50](#)
HTTP API [74](#)
HTTP Basic Authentication [42](#)
Hue [52](#), [68](#), [83](#)

I

Image [23](#), [24](#), [34](#)
Image Freezing [45](#), [53](#), [67](#), [77](#)
Import Configuration [44](#)
IP Address [19](#), [20](#), [54](#), [74](#), [87](#)
IR Remote Control [17](#), [46](#), [49](#), [50](#), [60](#), [76](#)
IR Remote Control Keys [46](#), [49](#)
Iris [31](#), [52](#), [59](#), [66](#), [82](#)

K

Kensington Lock [15](#)

L

LAN [17](#), [19](#), [41](#), [42](#)
Language [41](#), [51](#), [87](#)
License [41](#), [88](#)
Login [20](#)
Low Light Mode [34](#), [52](#)
Low Power Mode [45](#), [77](#)

M

Manual Exposure Mode [31](#)
MCU Version [43](#), [54](#), [68](#), [89](#)
Mini DIN-8 [18](#)
MJPEG [45](#)
Multicast [27](#), [81](#)

N

Network [40](#), [54](#), [60](#), [86](#)
Noise Reduction [23](#), [24](#), [34](#), [53](#), [59](#), [84](#)
NR-2D [34](#), [53](#), [66](#), [84](#)
NR-3D [34](#), [53](#), [67](#), [84](#)

O

OSD (On Screen Display) [38](#), [48](#), [50](#), [84](#)

P

Password [19](#), [20](#), [42](#), [81](#), [89](#)
PELCO-D [44](#), [51](#)
PELCO-P [44](#), [51](#)

PoE [15, 19](#)
Port [40](#)
Power [65](#)
Preset [45, 48, 53, 69, 77, 78](#)
PTZ [21, 45, 48, 53, 67, 76](#)

R

Reboot [43, 89](#)
Reboot Schedule [43](#)
Reset IP configuration (IP Address, Gateway, DNS server) [43](#)
RG Tuning [33, 52, 59, 66, 69, 83](#)
RJ45 [15](#)
RS-232 [15, 17, 17, 60, 61](#)
RS-485 [15, 17, 17, 18, 60](#)
RTMP [27](#)
RTP [26, 27, 81](#)
RTSP [26](#)

S

SAE Mode (Shutter Auto Exposure) [32, 82](#)
Saturation [52, 83](#)
SDI [15, 17, 17, 39, 48, 50, 55](#)
Serial [17, 44](#)
Sharpness [34, 52, 67, 83](#)
Shutter [31, 52, 66, 82](#)
Speed by Zoom [45, 53, 77](#)
SRT [27, 39, 74, 81, 86](#)
Style [35, 53, 84](#)
System Select [15, 55](#)

T

Tally Light [49, 69](#)
TCP [19, 61](#)
Time and Date [42, 84, 88](#)

U

UDP [19, 61](#)
Unicast [27](#)
USB [15, 17, 17](#)
Username [19, 20, 42, 81, 89](#)
UVC Version [68](#)

V

VBR [26](#)
Video Encoder [26, 79](#)
Video Format [55, 69, 85](#)
Video Output Format [39](#)
Video Streaming [27, 80](#)
VISCA [44, 51, 60, 61](#)
VISCA over IP [19, 61](#)

W

Wall Mount (AV-MT200) [15](#)
WB (White Balance) Mode [33, 52, 59, 65, 83](#)
WebGUI [20, 60](#)

X

XLR [16, 25](#)

Z

Zoom [47, 65](#)
Zoom Speed [45, 53, 77](#)



Avonic PTZ Camera 12x, 20x, 30x zoom
CM70-IP • CM71-IP • CM73-IP

© August 2023 • Version 1.5.2