

OMEGA™

4K / UHD

Two-Input Switcher

for HDMI and USB-C with USB Hub



Version Information

Version	Release Date	Notes
7	Jul 2024	Updated EDIDs for firmware 1.0.6

Sales, Marketing, and Customer Support

Main Office

Atlona Incorporated
1234 Lakeshore Dr Ste. 150
Coppell, TX 75019
United States

Office: +1.408.962.0515

Sales and Customer Service Hours
Monday - Friday: 8:00 a.m. - 6:30 p.m. (MST)

<https://atlona.com/>

International

+41 43 508 4321 (EMEA)
+65 6305 7575 (APAC)

Sales and Customer Service Hours
Monday - Friday: 09:00 - 17:00 (UTC +1)

Operating Notes



IMPORTANT: Visit <https://atlona.com/product/at-ome-mh21/> or <https://atlona.com/product/at-ome-mh21-cp/> for the latest firmware updates and User Manual.

Warranty



To view the product warranty, use the following link or QR code:

<https://atlona.com/warranty/>.

Safety and Certification



CAUTION: TO REDUCE THE RISK OF ELECTRIC SHOCK DO NOT OPEN ENCLOSURE OR EXPOSE TO RAIN OR MOISTURE. NO USER-SERVICEABLE PARTS INSIDE REFER SERVICING TO QUALIFIED SERVICE PERSONNEL.



The exclamation point within an equilateral triangle is intended to alert the user to the presence of important operating and maintenance instructions in the literature accompanying the product.



The information bubble is intended to alert the user to helpful or optional operational instructions in the literature accompanying the product.

1. Read these instructions.
2. Keep these instructions.
3. Heed all warnings.
4. Follow all instructions.
5. Do not use this product near water.
6. Clean only with a dry cloth.
7. Do not block any ventilation openings. Install in accordance with the manufacturer's instructions.
8. Do not install or place this product near any heat sources such as radiators, heat registers, stoves, or other apparatus (including amplifiers) that produce heat.
9. Do not defeat the safety purpose of a polarized or grounding-type plug. A polarized plug has two blades with one wider than the other. A grounding type plug has two blades and a third grounding prong. The wide blade or the third prong are provided for your safety. If the provided plug does not fit into your outlet, consult an electrician for replacement of the obsolete outlet.
10. Protect the power cord from being walked on or pinched particularly at plugs, convenience receptacles, and the point where they exit from the product.
11. Only use attachments/accessories specified by Atlona.
12. To reduce the risk of electric shock and/or damage to this product, never handle or touch this unit or power cord if your hands are wet or damp. Do not expose this product to rain or moisture.
13. Unplug this product during lightning storms or when unused for long periods of time.
14. Refer all servicing to qualified service personnel. Servicing is required when the product has been damaged in any way, such as power-supply cord or plug is damaged, liquid has been spilled or objects have fallen into the product, the product has been exposed to rain or moisture, does not operate normally, or has been dropped.



FCC Compliance

FCC Compliance and Advisory Statement: This hardware device complies with Part 15 of the FCC rules. Operation is subject to the following two conditions: 1) this device may not cause harmful interference, and 2) this device must accept any interference received including interference that may cause undesired operation. This equipment has been tested and found to comply with the limits for a Class A digital device, pursuant to Part 15 of the FCC Rules. These limits are designed to provide reasonable protection against harmful interference in a commercial installation. This equipment generates, uses, and can radiate radio frequency energy and, if not installed or used in accordance with the instructions, may cause harmful interference to radio communications. However there is no guarantee that interference will not occur in a particular installation. If this equipment does cause harmful interference to radio or television reception, which can be determined by turning the equipment off and on, the user is encouraged to try to correct the interference by one or more of the following measures: 1) reorient or relocate the receiving antenna; 2) increase the separation between the equipment and the receiver; 3) connect the equipment to an outlet on a circuit different from that to which the receiver is connected; 4) consult the dealer or an experienced radio/TV technician for help. Any changes or modifications not expressly approved by the party responsible for compliance could void the user's authority to operate the equipment. Where shielded interface cables have been provided with the product or specified additional components or accessories elsewhere defined to be used with the installation of the product, they must be used in order to ensure compliance with FCC regulations.

Copyright, Trademark, and Registration

© 2025 Atlona Inc. All rights reserved. "Atlona" and the Atlona logo are registered trademarks of Atlona Inc. Pricing, specifications and availability subject to change without notice. Actual products, product images, and online product images may vary from images shown here.

HDMI™ The terms HDMI, HDMI High-Definition Multimedia Interface, and the HDMI Logo are trademarks or registered trademarks of HDMI licensing Administrator, Inc.

Dolby, Dolby Atmos, and the double-D symbol are registered trademarks of Dolby Laboratories Licensing Corporation.

For DTS patents, see <http://patents.dts.com>. Manufactured under license from DTS, Inc. DTS, the Symbol, DTS and the Symbol together, and Digital Surround are registered trademarks and/or trademarks of DTS, Inc. in the United States and/or other countries. © DTS, Inc. All Rights Reserved.

All other trademark(s), copyright(s), and registered technologies mentioned(s) in this document are the properties of their respective owner(s).

Table of Contents

Introduction	7
Features	7
Package Contents	7
Panel Description	8
AT-OME-MH21	8
AT-OME-MH21-CP	9
Installation	10
Audio	10
RS-232 / IR	11
Connection Instructions	12
Connection Diagram	13
IP Configuration	14
Switching the IP Mode	14
Displaying the IP Address	14
Setting the IP Address using the Web Server	15
Auto IP Mode	16
Resetting to Factory-Default Settings	16
Device Operation	17
LED Indicators	17
Web Server	18
Registration	18
Logging In	19
Selecting the Input	20
Auto Switching	21
Enabling / Disabling Auto Switching	21
Scaling	22
Notes on Scaling	23
Audio Management	24
Audio Output Muting	24
De-embedding External Analog Audio	24
HDCP Content	25
EDID Management	26
Using the Downstream EDID	26
EDID Presets	27
Storing EDID Data	28
User Management	31
Changing the Administrator Password	31
Creating and Deleting User Accounts	32
System Configuration	33
Getting the MAC Address	33
Changing the Telnet Port	34
Telnet Login Mode	34
Adjusting Telnet Timeout	35
Setting the Host Name	36
Locking / Unlocking the Front Panel	37
Resetting to Factory-Default Settings	38
Downloading System Configuration	39
Restoring System Configuration	40
USB Modes	42
USB-C SuperSpeed Mode	42
Follow USB Mode	43
Manual Mode	44

Table of Contents

Configuration and Management Interfaces	45
Web Server	45
Info Page	45
I/O Settings Page	46
Display Page	48
RS-232 Page	52
EDID Page	53
Config Page	54
System Page	55
Appendix	58
Updating the Firmware	58
Using the Web Server	58
Using USB	60
Integration with the AT-OCS-900N	61
Mounting Instructions	63
Specifications	65
AT-OME-MH21	65
AT-OME-MH21-CP	68

Introduction

The Atlona **AT-OME-MH21** is a compact, versatile switcher with HDMI and USB-C inputs. It is equipped with features for complete AV integration in huddle rooms and small meeting spaces, including automatic switching and display control, audio de-embedding, and a USB 3.0 hub for video conferencing peripherals or touch displays. Part of the Omega™ Series of integration products for modern AV communications and collaboration, the OME-MH21 is HDCP 2.2 compliant and supports 4K HDR and 4K/60 4:4:4 at HDMI data rates up to 18 Gbps. Additionally, 4K downscaling to 1080p @ 60, 30, or 24 Hz is available when connected to an HD display. The OME-MH21 includes USB 3.0 and USB-C interfaces for two host PCs, plus two USB Type-A ports for peripheral devices such as a camera, microphone, speakerphone, touch-enabled display, or keyboard and mouse.

The Atlona **AT-OME-MH21-CP** is identical, but provides up to 60 watts of device charging capability for laptops and mobile devices through the USB-C port.

Features

- Two-input AV switcher
- USB-C input for AV and data
- Integrated USB 3.0 hub
- Selectable 4K to 1080p downscaling
- Automatic display control
- Automatic input selection using hot plug detect and video detection technology
- Delivers up to 60 watts of charging for laptops and mobile devices (AT-OME-MH21-CP only)

Package Contents

AT-OME-MH21

1 x AT-OME-MH21
1 x USB-C cable, 6.5 feet (2 meter)
1 x IR emitter
1 x 5-pin captive screw connector
1 x 4-pin captive screw connector
2 x Mounting brackets
4 x Mounting screws
4 x Rubber feet
1 x 5 V / 4 A DC power supply
1 x IEC power cord
1 x Installation Guide

AT-OME-MH21-CP

1 x AT-OME-MH21-CP
1 x USB-C cable, 6.5 feet (2 meter)
1 x IR emitter
1 x 5-pin captive screw connector
1 x 4-pin captive screw connector
2 x Mounting brackets
4 x Mounting screws
4 x Rubber feet
1 x 24 V / 5 A DC power supply
1 x IEC power cord
1 x Installation Guide

Panel Description

AT-OME-MH21

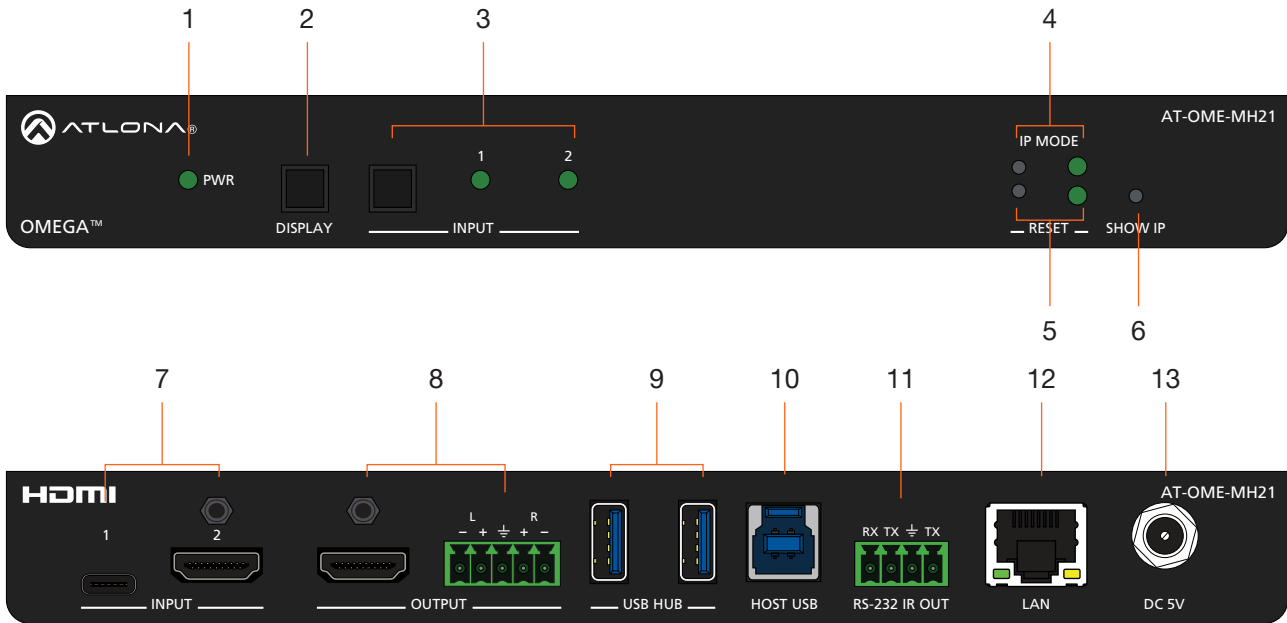

- | | |
|--|---|
| <p>1 PWR
This LED indicator glows solid green when the unit is powered.</p> <p>2 DISPLAY
Press and release this button to toggle power on the connected display.</p> <p>3 INPUT
Press and release this button to toggle between the HDMI and USB-C input. A solid green LED indicator will display the currently active input. Each LED indicator corresponds to the input on the rear panel of the unit.</p> <p>4 IP MODE
Press and release this button, next to the green LED indicator, to switch the IP mode between DHCP and static IP modes. The LED indicator will provide the current IP mode. Refer to IP Configuration (page 14) for more information.</p> <p>5 RESET
Press and release this button to reset the unit to factory-default settings. Refer to Resetting to Factory-Default Settings (page 16) for more information.</p> <p>6 SHOW IP
Press and release this button to display the IP address of the AT-OME-MH21 / AT-OME-MH21-CP on the connected display.</p> | <p>7 INPUT
Connect a USB-C source to the USB-C port. Connect an HDMI cable from the HDMI port to a UHD/HD source.</p> <p>8 OUTPUT
Connect an HDMI cable from the HDMI output to a display or other sink device. Connect an audio output device to this port using the included 5-pin captive screw block. Refer to Audio (page 10) for wiring information.</p> <p>9 USB HUB
Connect a USB device to each of these ports.</p> <p>10 HOST USB
Connect to a computer using a USB-B to USB-A cable.</p> <p>11 RS-232 / IR OUT
Connect the included 4-pin captive screw block to this receptacle. The RS-232 port provides RS-232 control for the AT-OME-MH21 / AT-OME-MH21-CP and the connected display. Refer to RS-232 / IR (page 11) for more information.</p> <p>12 LAN
Connect an Ethernet cable to this port to control the unit.</p> <p>13 DC 5V
Connect the included locking 5 V DC power supply to this power receptacle.</p> |
|--|---|

AT-OME-MH21-CP

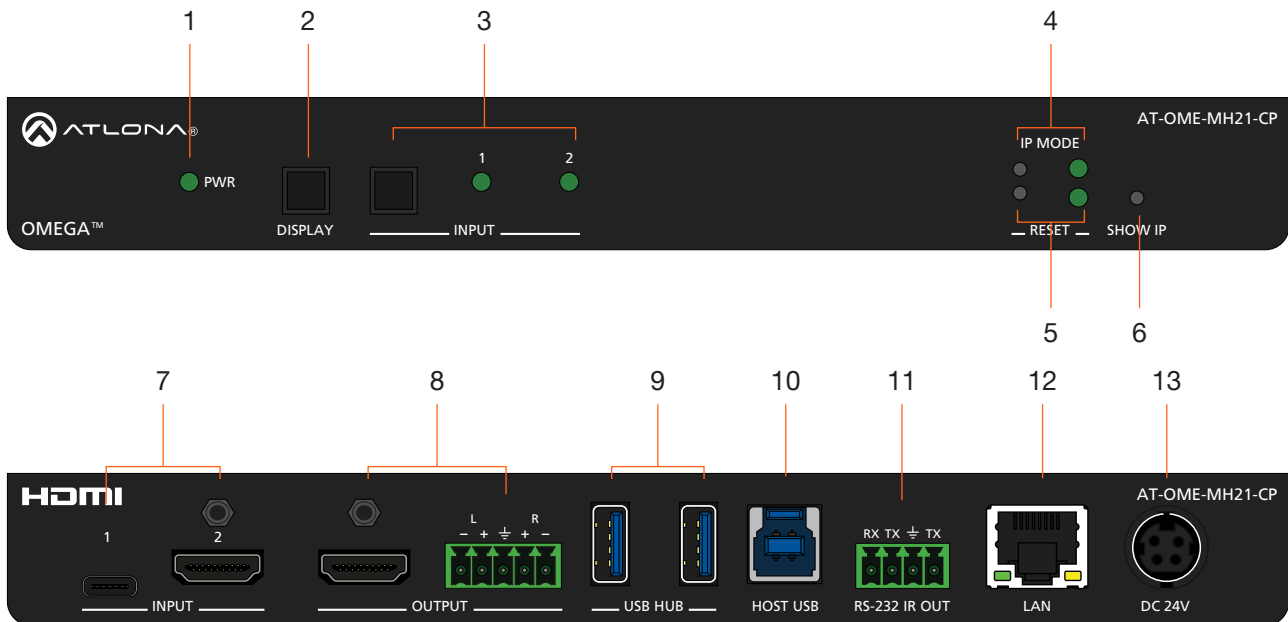

- 1 PWR**
This LED indicator glows solid green when the unit is powered.
- 2 DISPLAY**
Press and release this button to toggle power on the connected display.
- 3 INPUT**
Press and release this button to toggle between the HDMI and USB-C input. A solid green LED indicator will display the currently active input. Each LED indicator corresponds to the input on the rear panel of the unit.
- 4 IP MODE**
Press and release this button, next to the green LED indicator, to switch the IP mode between DHCP and static IP modes. The LED indicator will provide the current IP mode. Refer to [IP Configuration \(page 14\)](#) for more information.
- 5 RESET**
Press and release this button to reset the unit to factory-default settings. Refer to [Resetting to Factory-Default Settings \(page 16\)](#) for more information.
- 6 SHOW IP**
Press and release this button to display the IP address of the AT-OME-MH21 / AT-OME-MH21-CP on the connected display.
- 7 INPUT**
Connect a USB-C source to the USB-C port. Connect an HDMI cable from the HDMI port to a UHD/HD source.
- 8 OUTPUT**
Connect an HDMI cable from the HDMI output to a display or other sink device. Connect an audio output device to this port using the included 5-pin captive screw block. Refer to [Audio \(page 10\)](#) for wiring information.
- 9 USB HUB**
Connect a USB device to each of these ports.
- 10 HOST USB**
Connect to a computer using a USB-B to USB-A cable.
- 11 RS-232 / IR OUT**
Connect the included 4-pin captive screw block to this receptacle. The RS-232 port provides RS-232 control for the AT-OME-MH21 / AT-OME-MH21-CP and the connected display. Refer to [RS-232 / IR \(page 11\)](#) for more information.
- 12 LAN**
Connect an Ethernet cable to this port to control the unit.
- 13 DC 24V**
Connect the included 24 V DC power supply to this power receptacle.

Installation

Audio

The AT-OME-MH21 / AT-OME-MH21-CP provides two-channel LPCM audio de-embedding of the source device, using a dedicated audio output port. Use the included 5-pin captive-screw terminal block. Balanced audio connections use two signal wires and a ground to minimize interference in audio signals. Unbalanced output audio is not recommended and may require additional equipment.

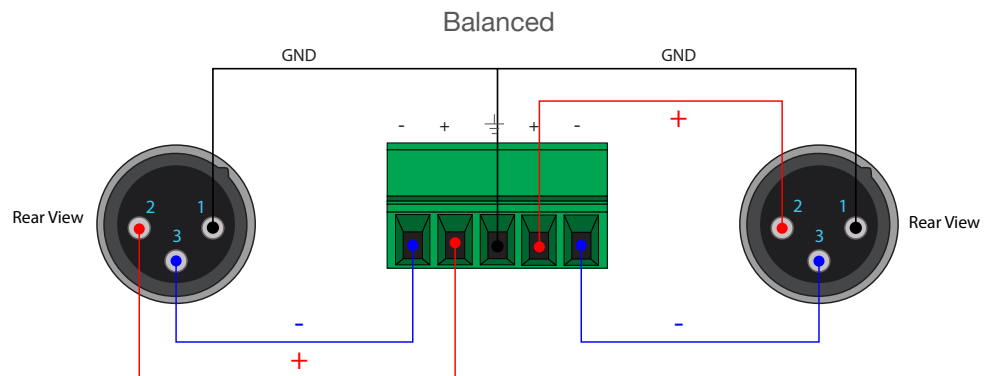
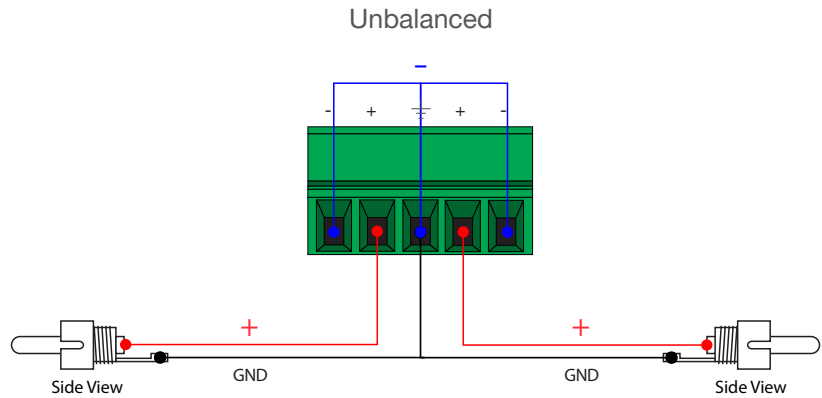
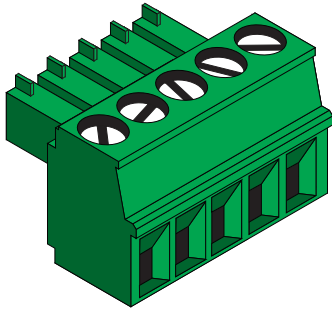

RS-232 / IR

The AT-OME-MH21 / AT-OME-MH21-CP provides control using RS-232 and/or IR. This step is optional.

1. Use wire strippers to remove a portion of the cable jacket.
2. Remove at least 3/16" (5 mm) from the insulation of the RX, TX, and GND wires for the RS-232 connection.
3. Insert the TX, RX, and GND wires into correct terminal using one of the included 4-pin captive screw connectors.
4. Repeat step 2 for the S and GND wires for the IR connection.
5. Insert the S (signal) wire in to the TX terminal and the ground wire to the GND terminal.
6. Tighten the captive screws to secure the wires in place. Do not over-tighten or use high-torque devices to prevent damage to the connector block.



NOTE: Typical DB9 connectors use pin 2 for TX, pin 3 for RX, and pin 5 for ground. On some devices functions of pins 2 and 3 are reversed. Note that the signal (S) pin for the IR is labeled as "TX" on the port.

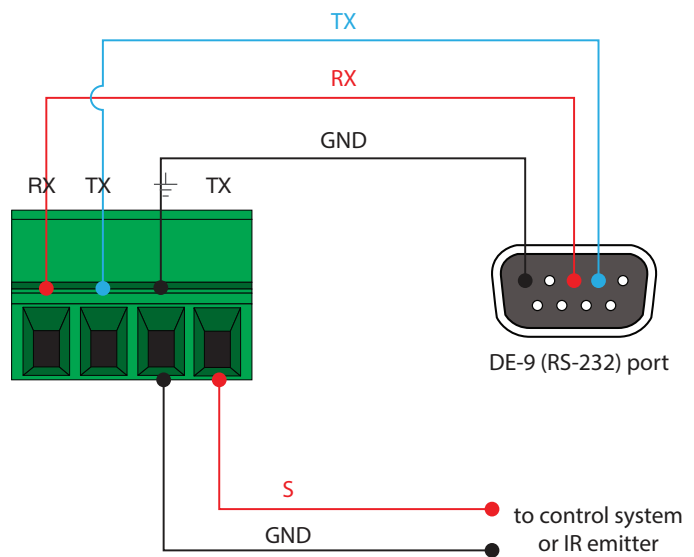
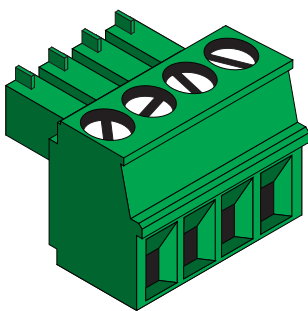

NOTE: If connecting an IR emitter, the wire that has the white line marking is the signal line (S). The black wire is ground (GND).

Connection Instructions

NOTE: Connection instructions for both the AT-OME-MH21 and AT-OME-MH21-CP are identical, except for the type of power supply.

1. Connect a USB-C device to the **INPUT 1** port.
2. Connect an HDMI cable from the **INPUT 2** port to a UHD/HD source device.
3. Connect an HDMI cable from the HDMI **OUTPUT** port to a display device.
4. **OPTIONAL:** Connect an audio output device to this port using the included captive screw block. Refer to [Audio \(page 10\)](#) for wiring information.
5. Connect up to two USB devices to the **USB HUB** ports.
6. Connect a computer to the **HOST USB** port, using a USB-A to USB-B cable.
7. **OPTIONAL:** Connect a serial cable from **RS-232** port to a display device. Refer to [RS-232 / IR \(page 11\)](#) for wiring information. Connect an IR emitter to the **IR OUT** port.
8. Connect an Ethernet cable to the **LAN** port to control the AT-OME-MH21 / AT-OME-MH21-CP.
9. Connect the included power supply from this receptacle to an available AC outlet. The AT-OME-MH21 uses a 5 V locking barrel connector. The AT-OME-MH21-CP uses a 24 V 4-pin DIN locking connector.

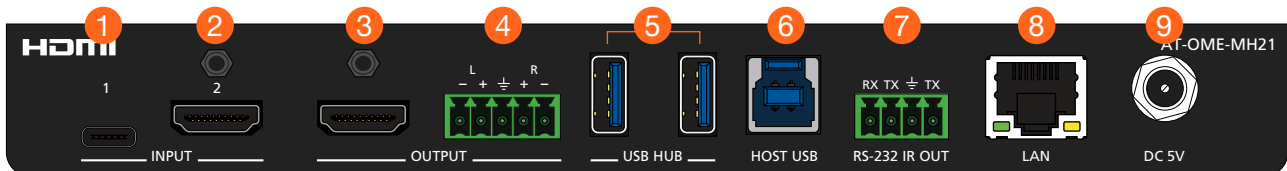

Connection Diagram

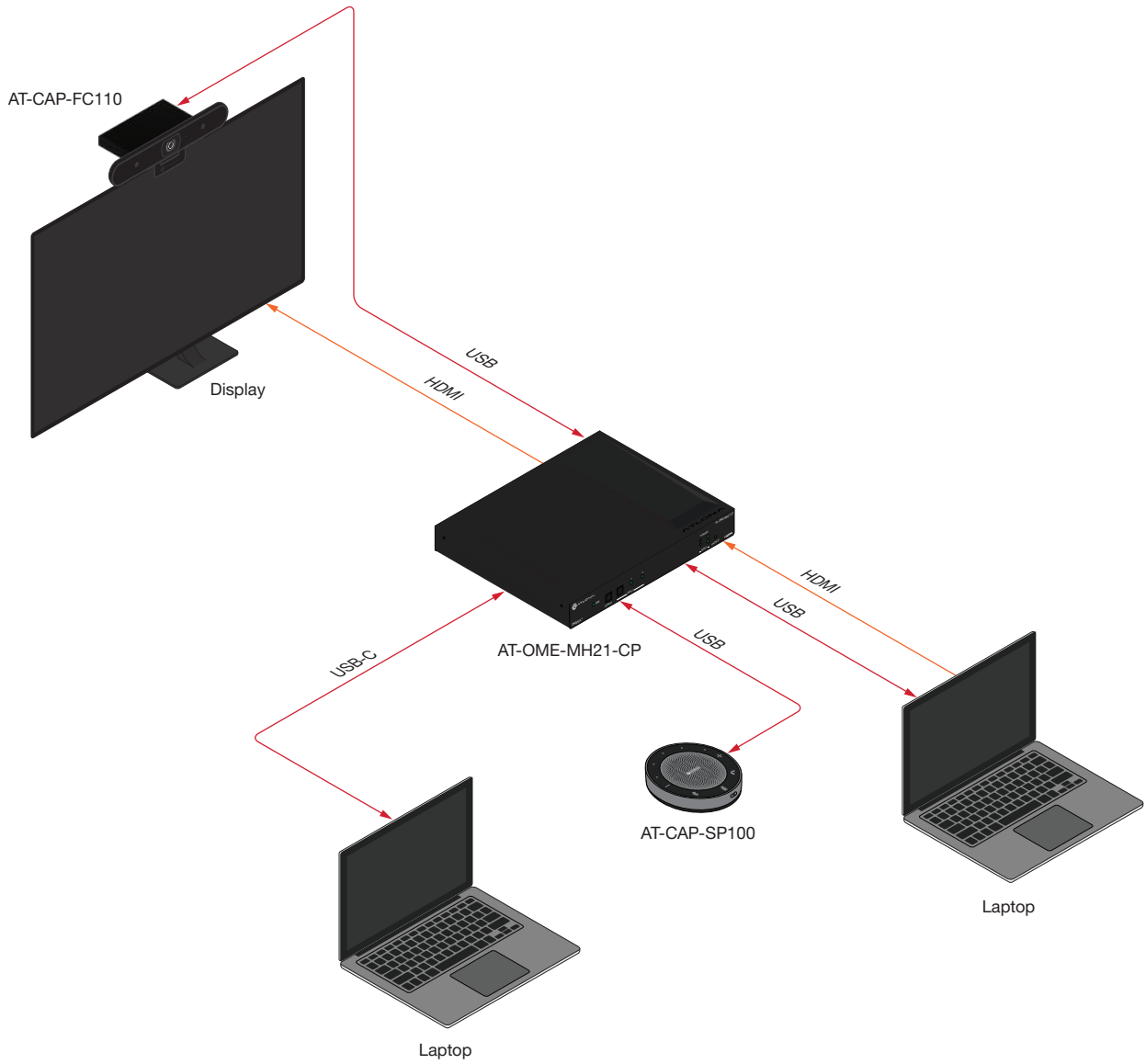

IP Configuration

The AT-OME-MH21 / AT-OME-MH21-CP is shipped with DHCP enabled. Once connected to a network, the DHCP server (if available), will automatically assign an IP address to the unit. Use an IP scanner, along with the MAC address on the bottom of the unit, to identify both the unit and its IP address on the network.

If the AT-OME-MH21 / AT-OME-MH21-CP is unable to detect a DHCP server within 15 seconds, then the unit will use a self-assigned IP address within the range 169.254.xxx.xxx/16. If this occurs, refer to [Auto IP Mode \(page 16\)](#) for more information.

If a static IP address is desired, the unit can be switched to static IP mode. Use one of the following procedures to switch between DHCP and static IP mode. The default static IP address of the AT-OME-MH21 is 192.168.1.254.

Switching the IP Mode

1. Make sure the AT-OME-MH21 / AT-OME-MH21-CP is powered and ready for operation.
2. Press and hold the **IP MODE** button.

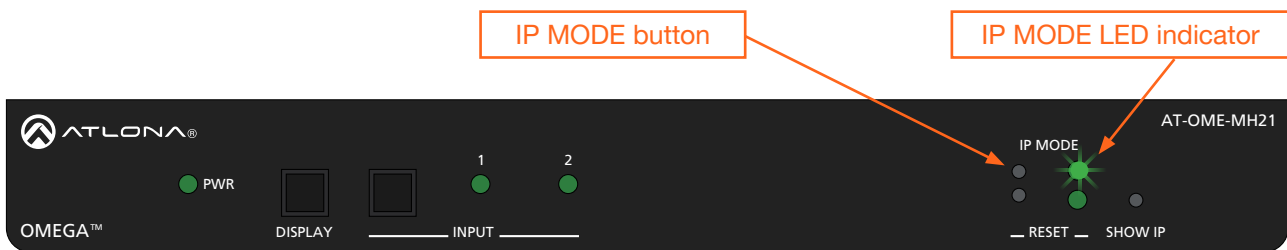

3. Release the button once the **IP MODE** LED indicator begins to flash green. The number of flashes will indicate the currently selected IP mode.

Input LED Indicators flash	Description
Two	DHCP mode
Three	Static IP mode (192.168.1.254 is default)

NOTE: If a static IP address is set using the web server, then changing the IP mode through the front panel will toggle between DHCP mode and the assigned static IP address in the web server.

Displaying the IP Address

1. Make sure the unit is powered.
2. Connect a display to the HDMI output and power the display.
3. Press and release the **SHOW IP** button on the front panel. The IP address will be displayed in the upper-left corner of the display.

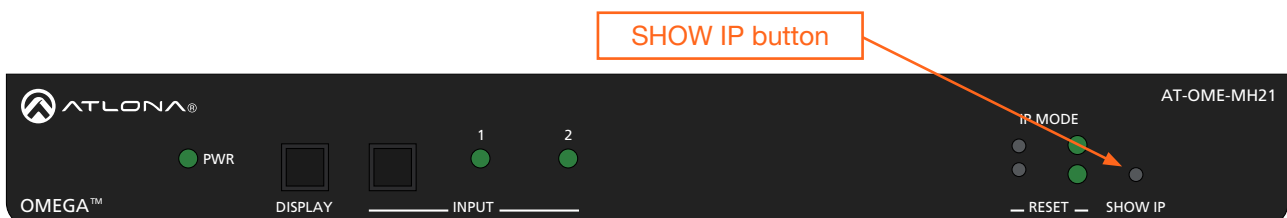

Setting the IP Address using the Web Server

The IP mode of the AT-OME-MH21 / AT-OME-MH21-CP can also be set using the built-in web server. In order to access the web server, the IP address of the AT-OME-MH21 / AT-OME-MH21-CP must be known. Refer to [Web Server \(page 18\)](#) for more information.

1. Open the desired web browser and enter the IP address of the AT-OME-MH21 / AT-OME-MH21-CP.
2. Login using the required credentials.
3. Click **System** in the menu bar.
4. Under the **Network** window group, click the **IP Mode** toggle switch to select either **DHCP**, or **STATIC IP**. The default setting is **DHCP**. If set to **STATIC IP**, the **IP**, **Netmask**, and **Gateway** fields can be modified.

By default, **STATIC IP** mode sets the IP settings to the following values:

IP Address: 192.168.1.254
 Network Mask: 255.255.0.0
 Gateway: 192.168.1.1

5. Click the **Save** button to commit changes.

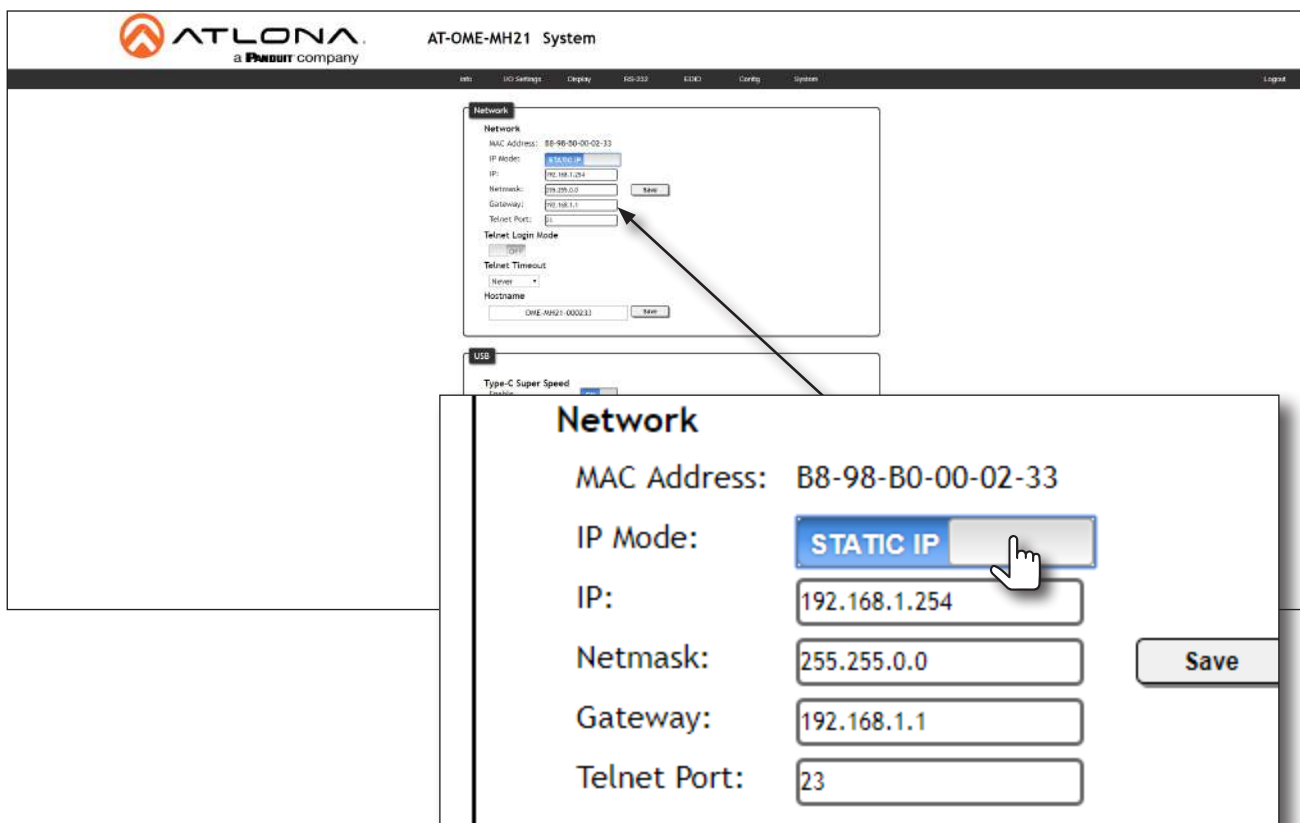

Auto IP Mode

If the AT-OME-MH21 / AT-OME-MH21-CP is unable to detect a DHCP server within 15 seconds, then the unit will use a self-assigned IP address within the range of 169.254.xxx.xxx. If this occurs, connect an Ethernet cable directly from the **LAN** port of the AT-OME-MH21 / AT-OME-MH21-CP to the LAN port of a computer, then do the following under Microsoft Windows.

1. Click **Start > Settings > Control Panel > Network and Sharing Center**.
2. Click **Change adapter settings**.
3. Right-click on the adapter that is used to establish a wired connection to the network, and select **Properties** from the context menu.
4. Under the **Ethernet Properties** dialog box, select **Internet Protocol Version 4** and then click the **Properties** button.
5. Click the **Use the following IP address** radio button.



IMPORTANT: Before continuing, write down the current IP settings in order to restore them, later. If **Obtain an IP address automatically** and **Obtain DNS server automatically** are selected, then this step is not required.

6. Enter the desired static IP address or the IP address provided by the network administrator. If the computer does not require Internet access or if a statically-assigned IP address is being used, then an IP address of 169.254.xxx.xxx can be entered.
7. Set the subnet mask to 255.255.0.0.
8. Click the **OK** button then close all **Control Panel** windows.

Resetting to Factory-Default Settings



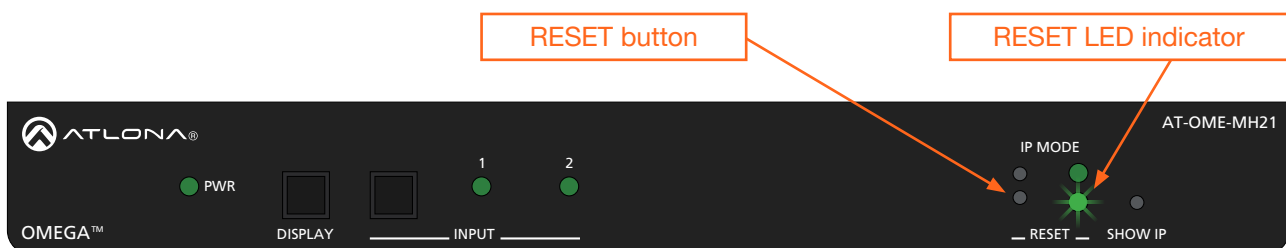





1. Press and hold the **RESET** button for five seconds.
2. Release the **RESET** button once the **RESET** LED indicator begins to flash. The LED indicator will flash three times to indicate that the unit has been reset to factory-default settings.



Device Operation

LED Indicators

The LED indicators on both the front and rear of the unit provide basic information on the current status of the AT-OME-MH21 / AT-OME-MH21-CP.

LED		Description
PWR	Solid green 	<ul style="list-style-type: none"> Unit is powered.
	Off 	<ul style="list-style-type: none"> Unit is not powered.
INPUT	Solid 	<ul style="list-style-type: none"> The input is the currently selected (active) input.
	Off 	<ul style="list-style-type: none"> The input is not active.
IP MODE	Flash green (2x) 	<ul style="list-style-type: none"> Flashes twice to indicate that the unit is being set to DHCP mode. Refer to IP Configuration (page 19) for more information.
	Flash green (3x) 	<ul style="list-style-type: none"> Flashes three times to indicate that the unit is being set to static IP mode and will be assigned the IP address of 192.168.1.254.
	Off	<ul style="list-style-type: none"> Normal operating mode.
RESET	Flash green (3x) 	<ul style="list-style-type: none"> Unit is being set to factory-default settings. Refer to Resetting to Factory-Default Settings (page 16) for more information.
	Off 	<ul style="list-style-type: none"> Normal operating mode.

Web Server

Most of the AT-OME-MH21 / AT-OME-MH21-CP operation is handled through the built-in web server. In order to access the web server, the IP address of the unit must be known. Refer to [IP Configuration \(page 14\)](#) for more information. Before using the web server, it must be registered with a username and password.

Registration

1. Launch a desired web browser and enter the IP address of the AT-OME-MH21 / AT-OME-MH21-CP in the address bar.
2. Enter the desired username in the **Username** field. In the example below, the username `admin` is used.



IMPORTANT: The password must contain a minimum of 8 characters, including: 1 uppercase character, 1 lowercase character, and 1 number.

3. Enter the desired password in the **Password** field.
4. Verify the password by entering it in the **Confirm** field.

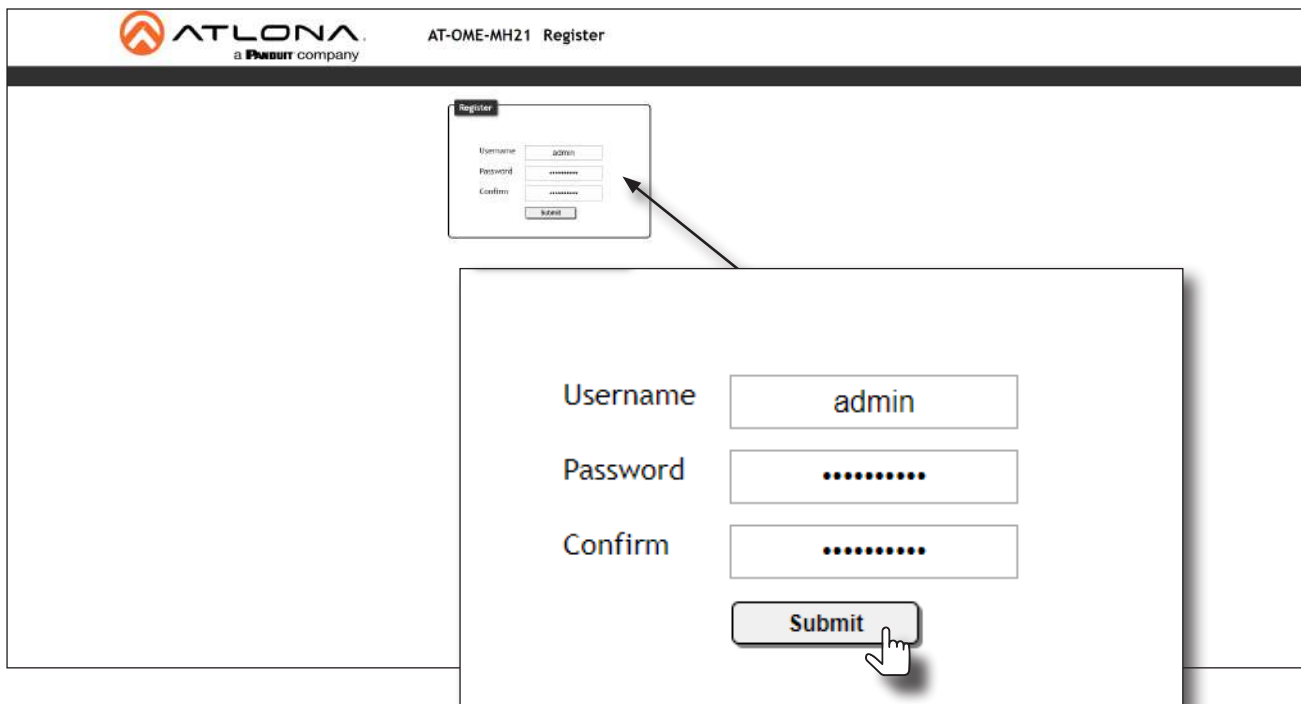

The screenshot displays the 'AT-OME-MH21 Register' web interface. At the top, the ATLONA logo and 'a PANDUIT company' are visible on the left, and 'AT-OME-MH21 Register' is on the right. The main content area features a registration form with three input fields: 'Username' (containing 'admin'), 'Password' (masked with dots), and 'Confirm' (masked with dots). Below these fields is a 'Submit' button. A callout box provides a magnified view of the form, showing the 'Submit' button being clicked by a mouse cursor.

5. Click the **Submit** button.
6. The **Login** page will be displayed.
7. Registration is complete.

Logging In

Before logging in to the web server, make sure the registration process has been completed. Refer to [Registration \(page 18\)](#) for more information.

1. Launch the desired web browser and enter the IP address of the AT-OME-MH21 / AT-OME-MH21-CP in the address bar.
2. Enter the correct username and password in the respective fields.



NOTE: If using a secure connection, click the **Toggle HTTP/HTTPS** button.

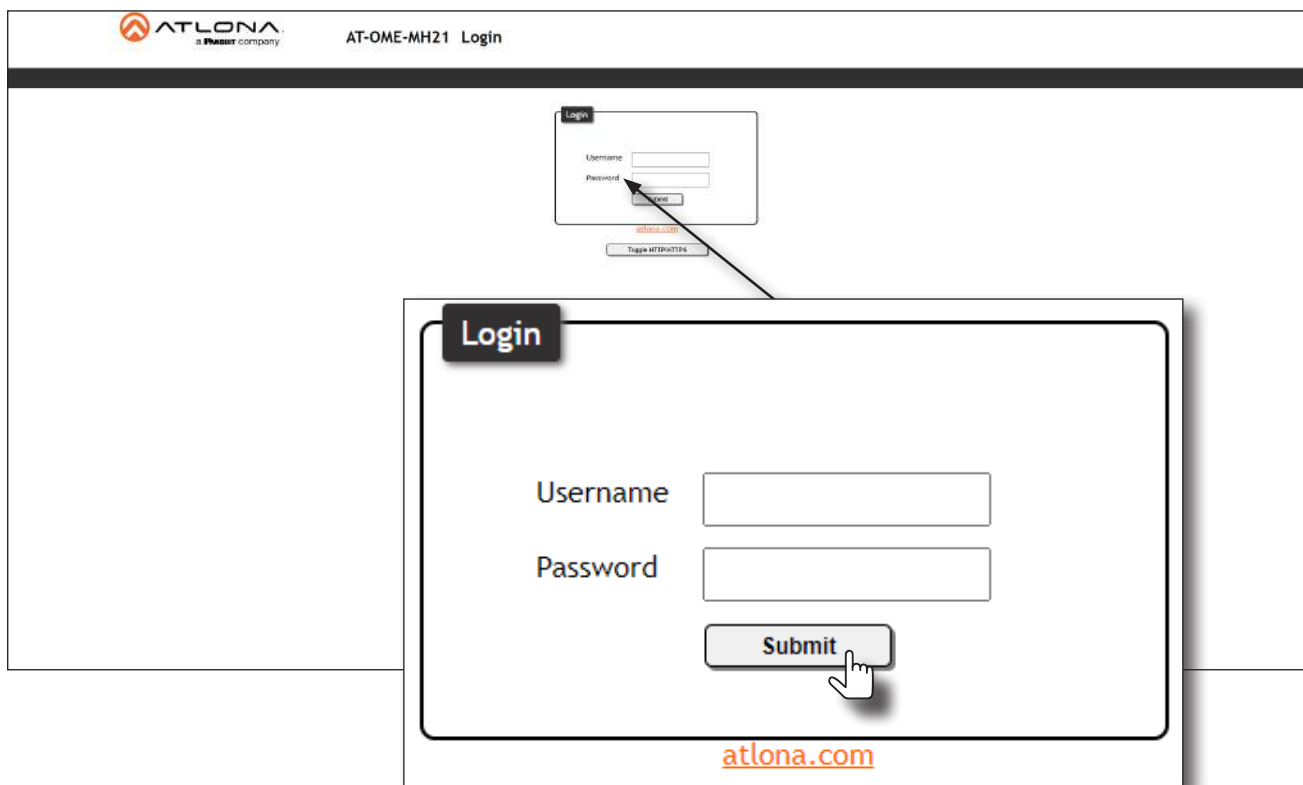

The screenshot displays the AT-OME-MH21 Login interface. At the top, the ATLONA logo and 'AT-OME-MH21 Login' are visible. The main area contains a login form with 'Username' and 'Password' input fields, a 'Submit' button, and a 'Toggle HTTP/HTTPS' button. A callout box provides a magnified view of the login form, showing the 'Username' and 'Password' fields and the 'Submit' button. A hand cursor is shown clicking the 'Submit' button. The URL 'atlona.com' is visible at the bottom of the callout box.

3. Click the **Submit** button.
4. The **Info** page will be displayed and the login process is complete.

Selecting the Input

1. Login to the web server. Refer to [Web Server](#) (page 18) for more information.
2. Click **I/O Settings** in the menu.
3. Under the **Output** window group, click the **Input Selection** drop-down list to select the desired input.

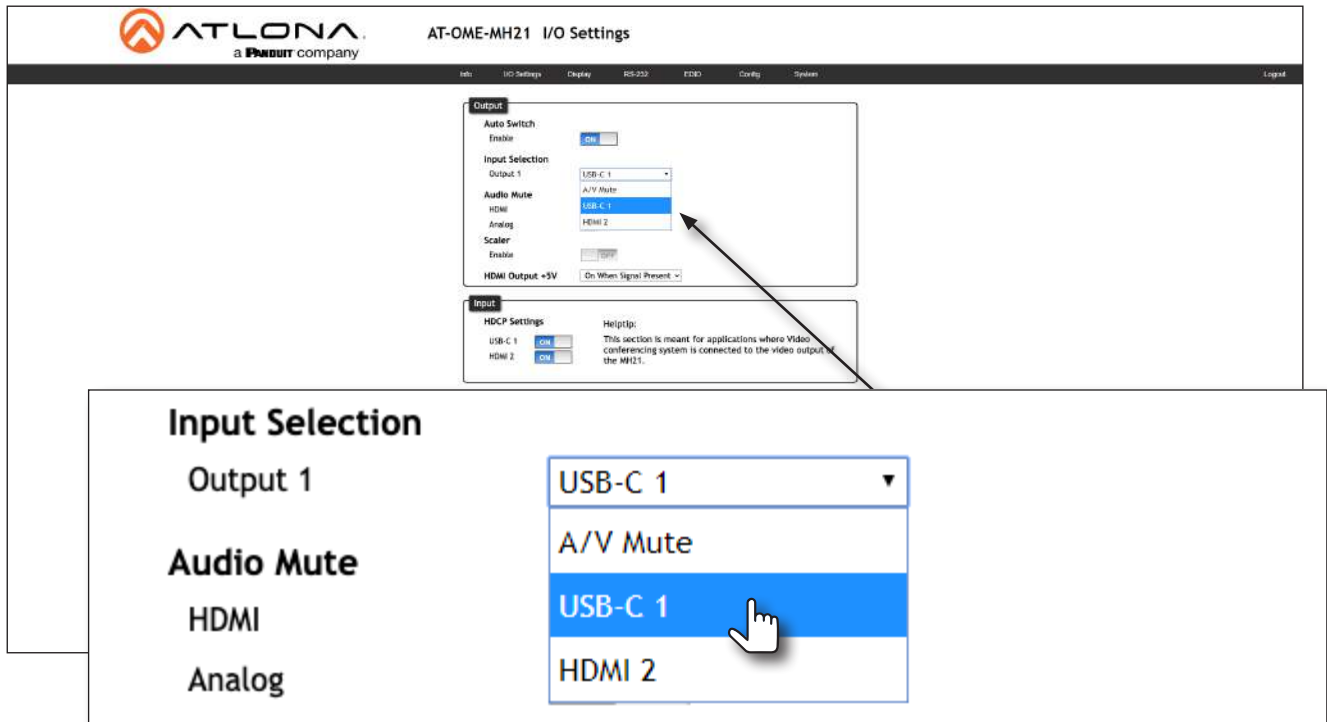

Selecting **A/V Mute** will disable the audio and video output on both the HDMI and analog output ports.

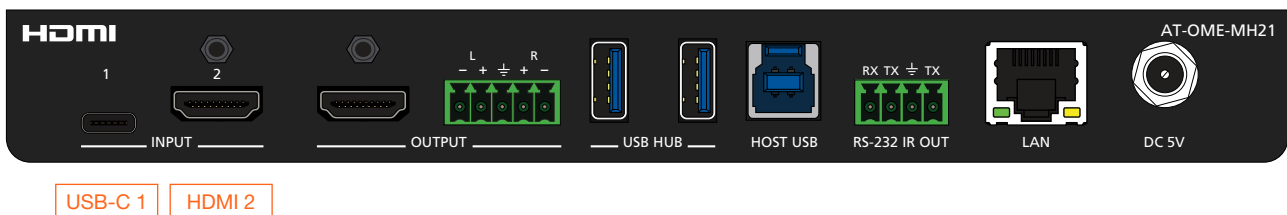

Auto Switching

The AT-OME-MH21 / AT-OME-MH21-CP provides auto switching capability, which is enabled by default. This feature will automatically switch the input to the most recently-connected source. If a source is disconnected, then the input will automatically be switched to the previously-connected source.

Enabling / Disabling Auto Switching

By default, auto-switching is enabled on the AT-OME-MH21 / AT-OME-MH21-CP, allowing the unit to automatically switch between inputs when sources are connected or disconnected.

1. Login to the web server. Refer to [Web Server \(page 18\)](#) for more information.
2. Click **I/O Settings** in the menu bar.
3. Click the **Auto Switch mode** toggle switch to the **ON** position to enable auto-switching. This is the default setting. If auto switching is not desired, click this toggle switch to the **OFF** position.



NOTE: The AT-OME-MH21 / AT-OME-MH21-CP retains the currently selected input, even after the unit is powered-off then powered-on. The system will re-evaluate the auto switching logic after power on and select an input.

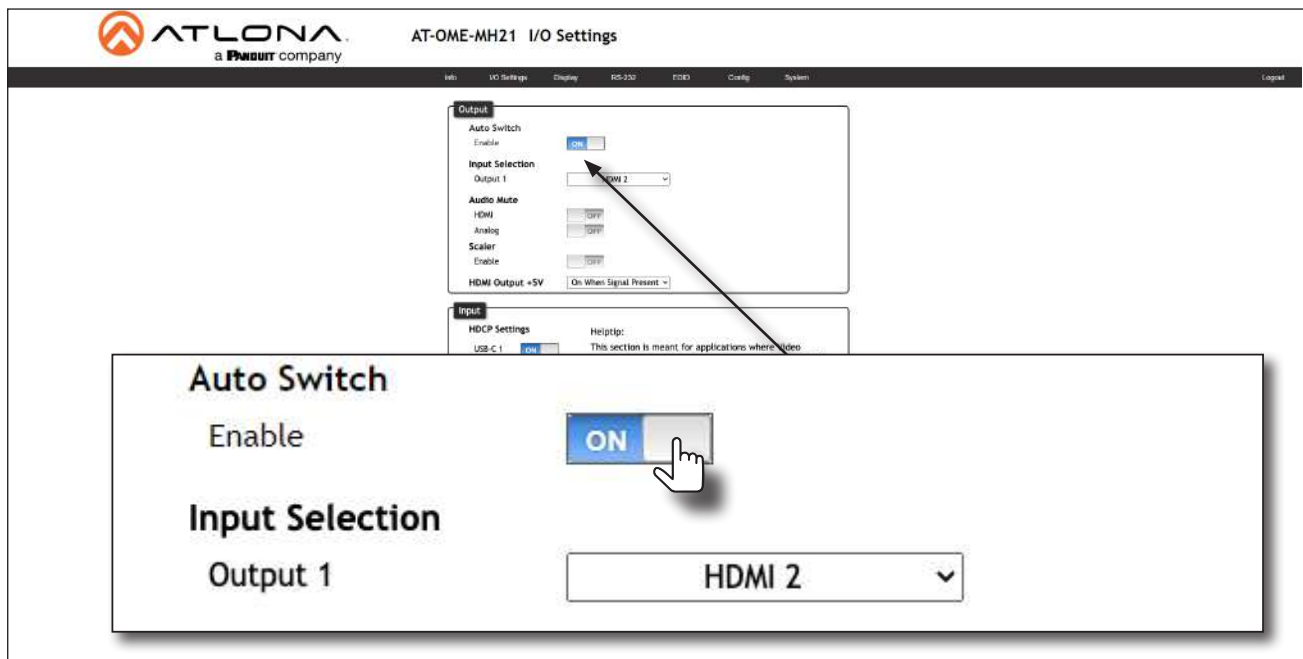

The screenshot shows the AT-OME-MH21 I/O Settings web interface. The 'Output' section includes the following settings:

- Auto Switch:** ON (toggle switch)
- Input Selection:** HDMI 2 (dropdown menu)
- Audio Mute:** OFF (toggle switch)
- HDMI Output +5V:** On When Signal Present (dropdown menu)

The 'Input' section includes:

- HDCP Settings:** USB C 1 (toggle switch)
- Help tip:** This section is meant for applications where video

A callout box highlights the 'Auto Switch' toggle and the 'Input Selection' dropdown menu, showing the 'ON' position and 'HDMI 2' selection.

4. Auto switching configuration is complete.

Scaling

Click this toggle switch to enable or disable the scaling feature. When set to the **ON** position, 4K content will be down-scaled to 1080p. When set to the **OFF** position, the output resolution / timing will be the same as the input source. The default setting is **OFF**.



IMPORTANT: The scaler will only downscale the image resolution and does not support frame rate scaling/conversion such as 60 Hz to 30 Hz. The frame rate of the source must be supported by the display device.

1. Login to the web server. Refer to [Web Server \(page 18\)](#) for more information.
2. Click **I/O Settings** in the menu bar.
3. Click the **Scaler** toggle switch.

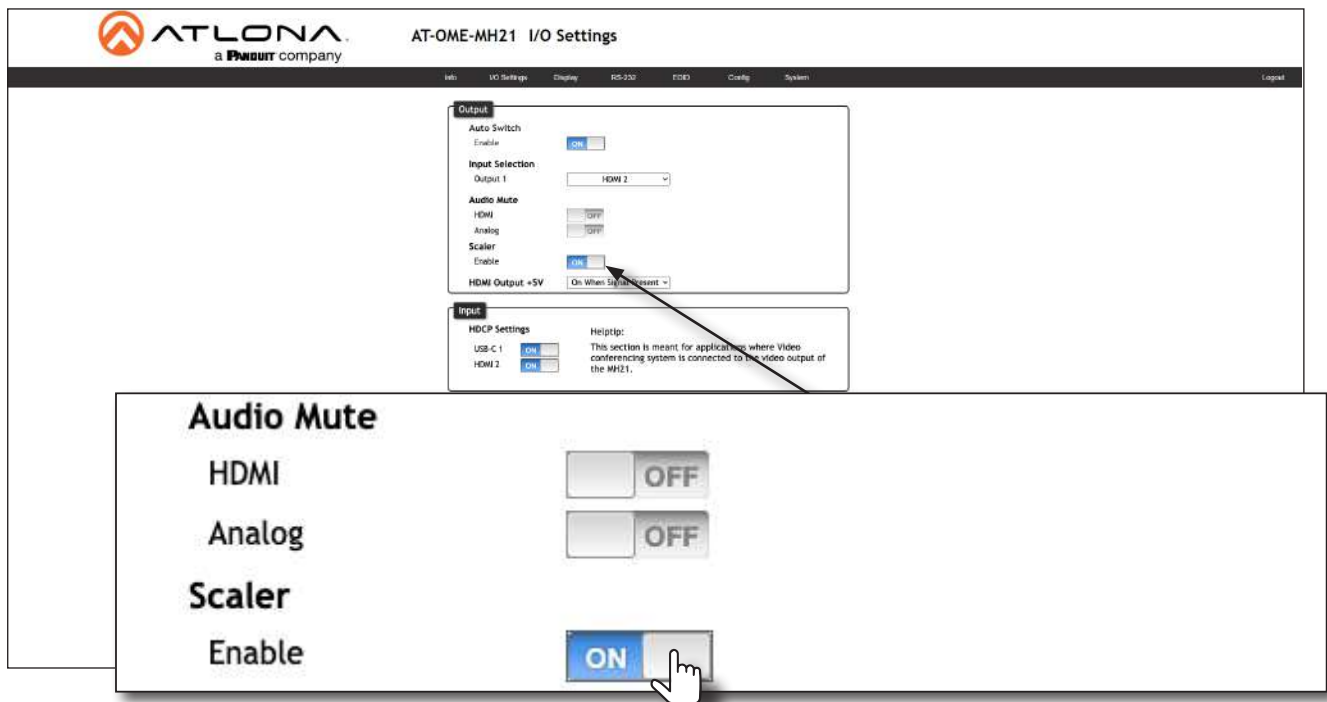

The screenshot shows the AT-OME-MH21 I/O Settings page. The 'Scaler' toggle switch is currently in the 'ON' position. A red box highlights the 'Scaler' section, and a larger, detailed view of this section is shown below, with a mouse cursor clicking the 'ON' button.

4. Click the toggle switch again, to return the **Scaler** toggle to the **OFF** (default) position.

Notes on Scaling

The following section provides important information about how the AT-OME-MH21 / AT-OME-MH21-CP processes 4K (UHD) video signals.

- The HDMI **OUTPUT** port supports up to 4K @ 60 Hz, 12-bit, with HDR.
- If the source is 4K, and the HDMI **OUTPUT** port is connected to a 1080p (not 4K-capable) display, then the output will be down-scaled as follows:

Input	Output
4K @ 24 Hz	1080p @ 24 Hz
4K @ 30 Hz	1080p @ 30 Hz
4K @ 60 Hz, 4:2:0	1080p @ 60 Hz, YUV/RGB 4:4:4

- HDR / Dolby Vision / HLG formats cannot be down-scaled to 1080p. If the source content has HDR, then the color saturation on the video output may appear “washed out”.
- The internal scaler will be bypassed if the connected display supports the resolution and timing information from the source device.

Audio Management

The AT-OME-MH21 / AT-OME-MH21-CP provides control over audio muting on both the **HDMI** and **ANALOG** outputs.

Audio Output Muting

1. Login to the web server. Refer to [Web Server \(page 18\)](#) for more information.
2. Click **I/O Settings** in the menu bar.
3. Locate the **Audio Mute** section.
4. Click the toggle switch for the desired output. For example, to mute the audio output on the **HDMI** output, set this toggle switch to the **ON** position. To re-enable the audio for the output, set the toggle switch to the **OFF** position.

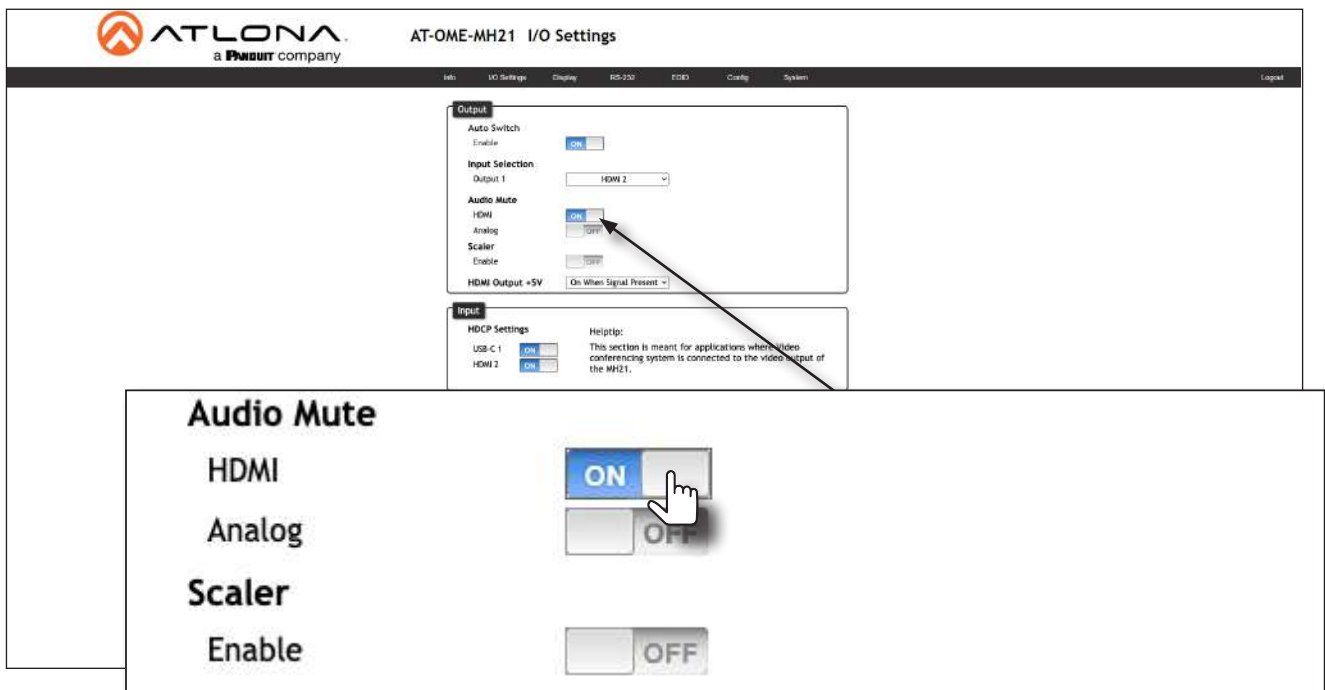

De-embedding External Analog Audio

Digital audio can be de-embedded from the **HDMI** or **USB-C** inputs and output to an external audio device over the analog **OUTPUT** port. De-embedded audio is limited to analog two-channel audio. LPCM multichannel audio is downmixed to two-channel LPCM audio. Refer to the [Audio \(page 10\)](#) for wiring information.

HDCP Content

Normally, if a source is transmitting HDCP content to a display that is not HDCP-compatible, then the resulting image on the display can be “snow”, image flickering, or no picture. For example, in the illustration below, a blu-ray player is connected to the AT-OME-MH21 / AT-OME-MH21-CP. A non-compliant display is connected to a receiver, which is connected to the AT-OME-MH21 / AT-OME-MH21-CP using HDMI.



IMPORTANT: Not all source devices are capable of transmitting non-HDCP content. For example, Sony PlayStation® gaming consoles and Apple® computers will always default to HDCP. However, if they detect a non-hdcp source, non-hdcp content will be transmitted.

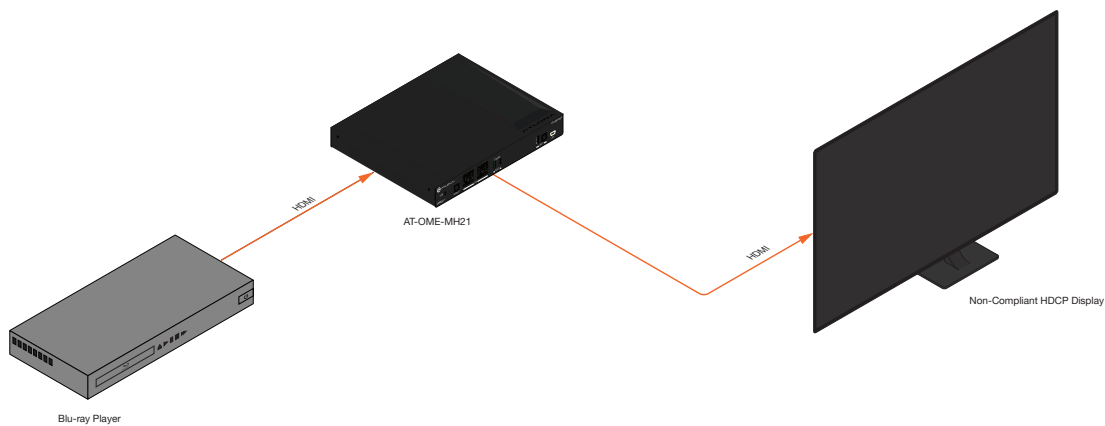

By default, the laptop may transmit HDCP content. However, when connected to a display that does not support HDCP, the laptop must be instructed to send non-HDCP content, in order for the content to be displayed.

1. Login to the web server. Refer to [Web Server \(page 18\)](#) for more information.
2. Click **I/O Settings** in the menu bar.
3. Locate the **Input** section.
4. Click the toggle switch next to the desired input. In this example, clicking the **USB-C 1** toggle switch and setting it to the **OFF** position will instruct the source connected to the USB-C port to send non-HDCP content, if possible. If the display is unable to receive HDCP content, then a green splash screen will appear on the connected display, with the following message:

HDCP INCOMPATIBILITY

Input

HDCP Settings		Helptip:
USB-C 1	<input type="checkbox"/> OFF	This section is meant for applications where Video conferencing system is connected to the video output of the MH21.
HDMI 2	<input checked="" type="checkbox"/> ON	

EDID Management

Before a source can send picture and sound to a display device, the source reads the EDID (Extended Display Identification Data) stored in the display. The EDID contains information about what type of video and audio formats are supported by the display. The AT-OME-MH21 / AT-OME-MH21-CP can use either the downstream EDID (from the display/sink) or use a built-in EDID preset. Custom EDID data can also be stored in a user-defined preset. This section will cover each of the following topics:

- EDID Presets
- Using the Downstream EDID
- Storing EDID Data

Using the Downstream EDID

By default, the AT-OME-MH21 / AT-OME-MH21-CP will read the EDID from the display device. The term “downstream” is used to describe any device that receives a signal from another device. For example, if a Blu-ray player is connected to a display, the display is said to be “downstream” of the Blu-ray player.

1. Login to the web server. Refer to [Web Server \(page 18\)](#) for more information.
2. Click **EDID** in the menu bar.
3. Locate the **EDID Settings** section.
4. Click the drop-down list next to the desired input and select **Connected Displays**. For example, to have the **USB-C 1** port use the EDID of the connected display, click the **Input 1** drop-down list and select **Connected Displays**.

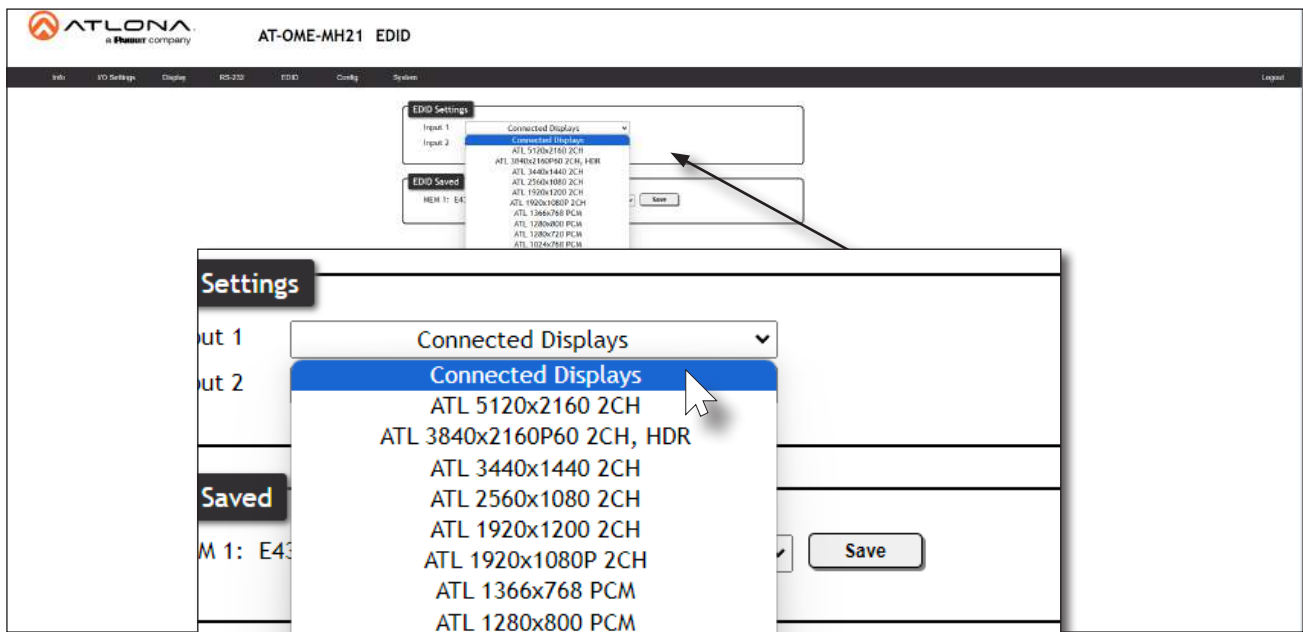

5. Downstream EDID configuration is complete.

EDID Presets

The AT-OME-MH21 / AT-OME-MH21-CP provides the option of selecting a preset EDID. The following presets are available. For information on the **Mem 1** setting, refer to [Storing EDID Data \(page 28\)](#).



IMPORTANT: If problems are encountered when using an EDID preset, try using the default setting of **Connected Displays**.

EDID Preset	
Connected Displays	The default setting; uses the EDID of the connected display
ATL 5120x2160	5120 x 2160 @ 30 Hz with two-channel audio support.
ATL 3840x2160P60 2CH, HDR	3840 x 2160 @ 60 Hz with two-channel audio and HDR support
ATL 3440x1440 2CH	3440 x 1440 @ 50 Hz with two-channel audio support.
ATL 2560x1080 2CH	2560 x 1080 @ 60 Hz with two-channel audio support.
ATL 1920x1200 2CH	1920 x 1200 @ 60 Hz with two-channel audio support.
ATL 1920x1080P 2CH	1920 x 1080 @ 60 Hz with two-channel audio support.
ATL 1366x768 PCM	1366 x 768 @ 60 Hz with two-channel audio support.
ATL 1280x800 PCM	1280 x 800 @ 60 Hz with two-channel audio support.
ATL 1280x720 PCM	1280 x 720 @ 60 Hz with two-channel audio support.
ATL 1024x768 PCM	1024 x 768 @ 60 Hz with two-channel audio support.
Mem 1	EDID memory storage

1. Login to the web server. Refer to [Web Server \(page 18\)](#) for more information.
2. Click **EDID** in the menu bar.
3. Locate the **EDID Settings** section.
4. Click the drop-down list, next to the port that is connected to the display device, and select the desired EDID preset. For example, to have the **USB-C 1** port use a specific EDID, click the **Input 1** drop-down list.

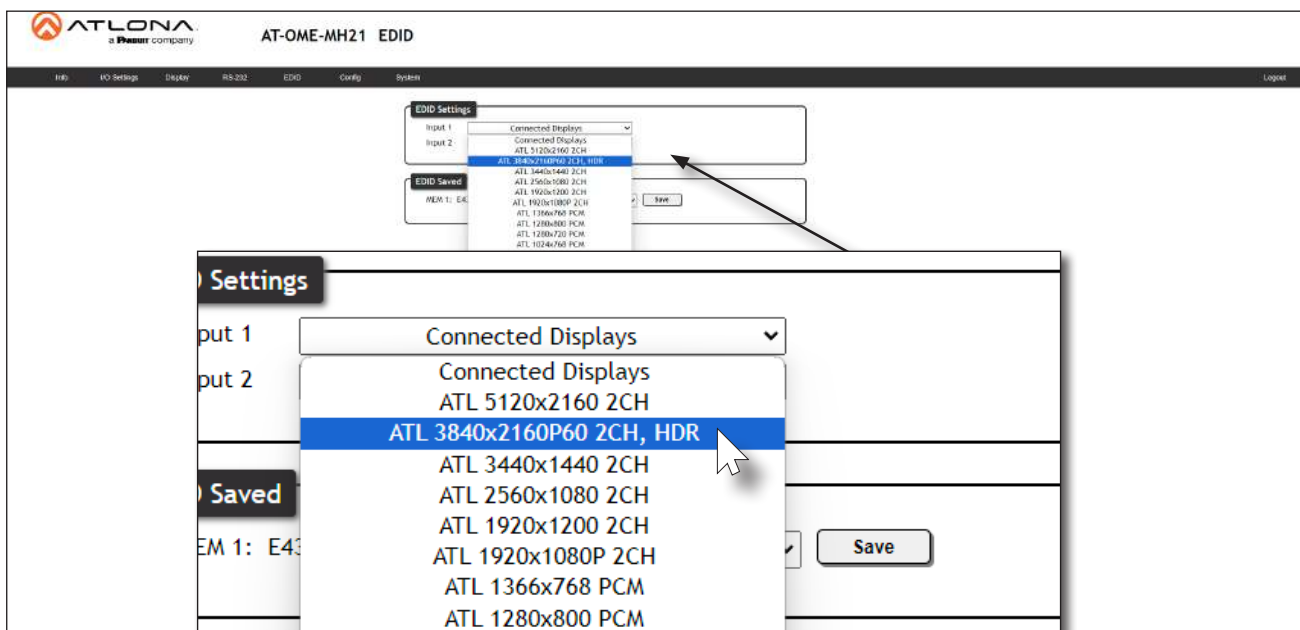

5. EDID preset selection is complete.

- Click the drop-down list and select **Output 1**, which refers to the HDMI **OUTPUT** port on the AT-OME-MH21 / AT-OME-MH21-CP.

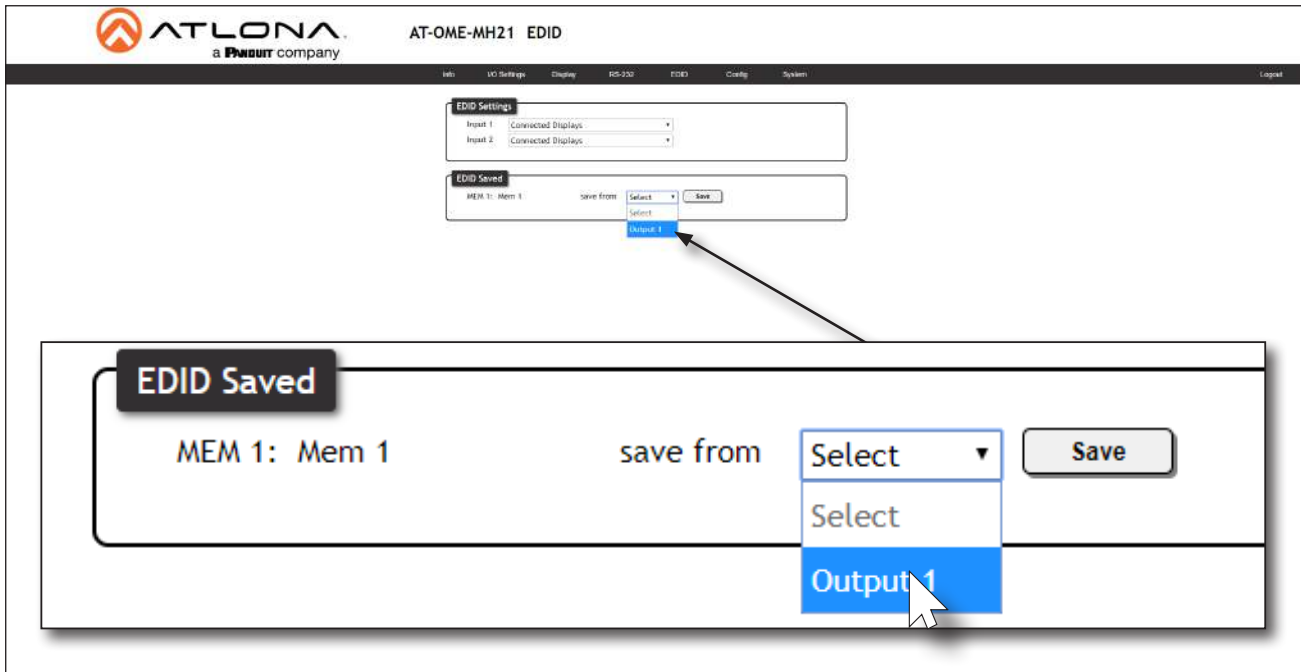

- Click the **Save** button next to the drop-down list for the memory location.



- The saved EDID will appear next to the memory location, as shown below.

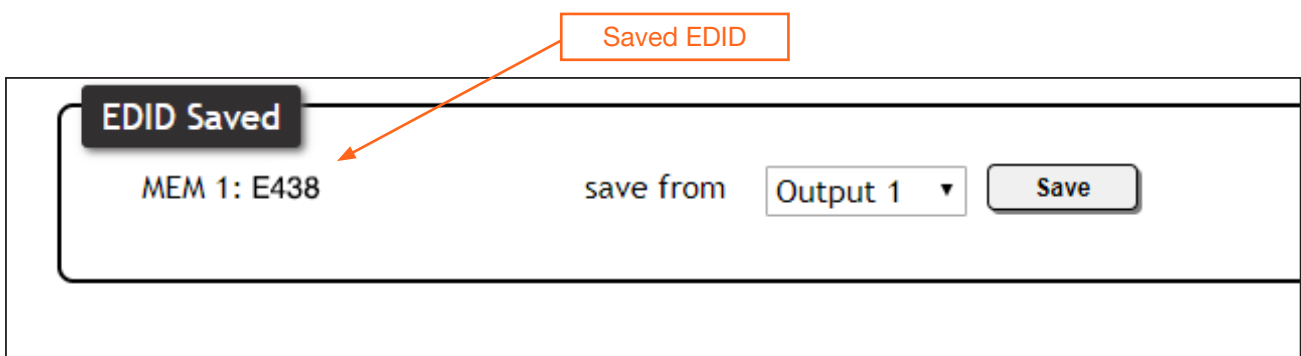

8. Click any of the input drop-down list boxes, under the **EDID Settings** window group. Note that the stored EDID appears as an available EDID preset for each available input on the AT-OME-MH21 / AT-OME-MH21-CP.

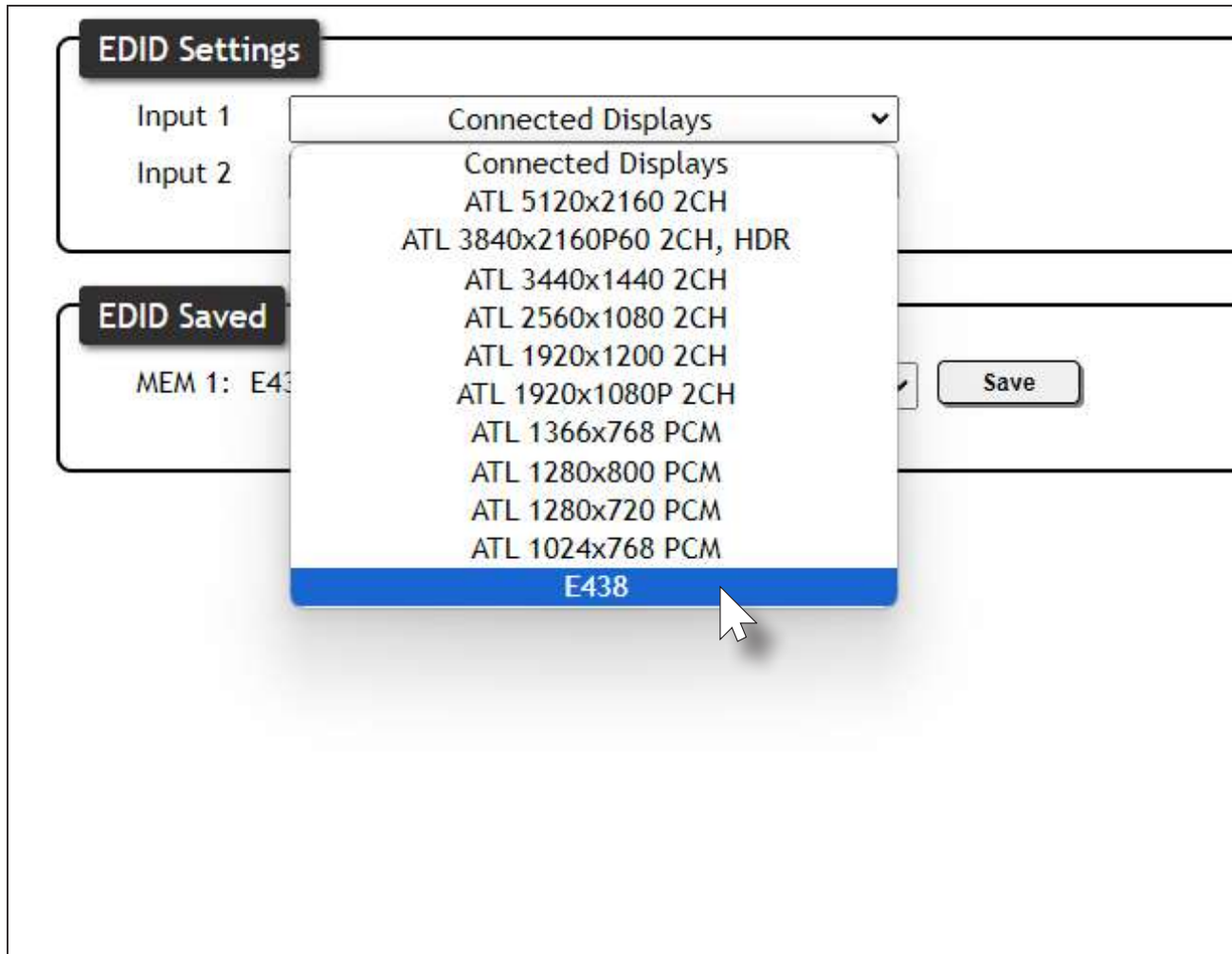

9. The EDID storing procedure is completed.



NOTE: Once an EDID is written to a memory location, it can be overwritten with a different EDID, when desired. To overwrite an EDID with a different EDID, repeat steps 5 through 7, above.

User Management

The AT-OME-MH21 / AT-OME-MH21-CP allows the administrator password to be changed, as well as the ability to create and remove user accounts.. Passwords apply to both the web server and Telnet sessions. The username for the administrator account cannot be changed.

Changing the Administrator Password

1. Login to the web server. Refer to [Web Server \(page 18\)](#) for more information.
2. Click **Config** in the menu bar.
3. Click the **Old Password** field and enter the current password.

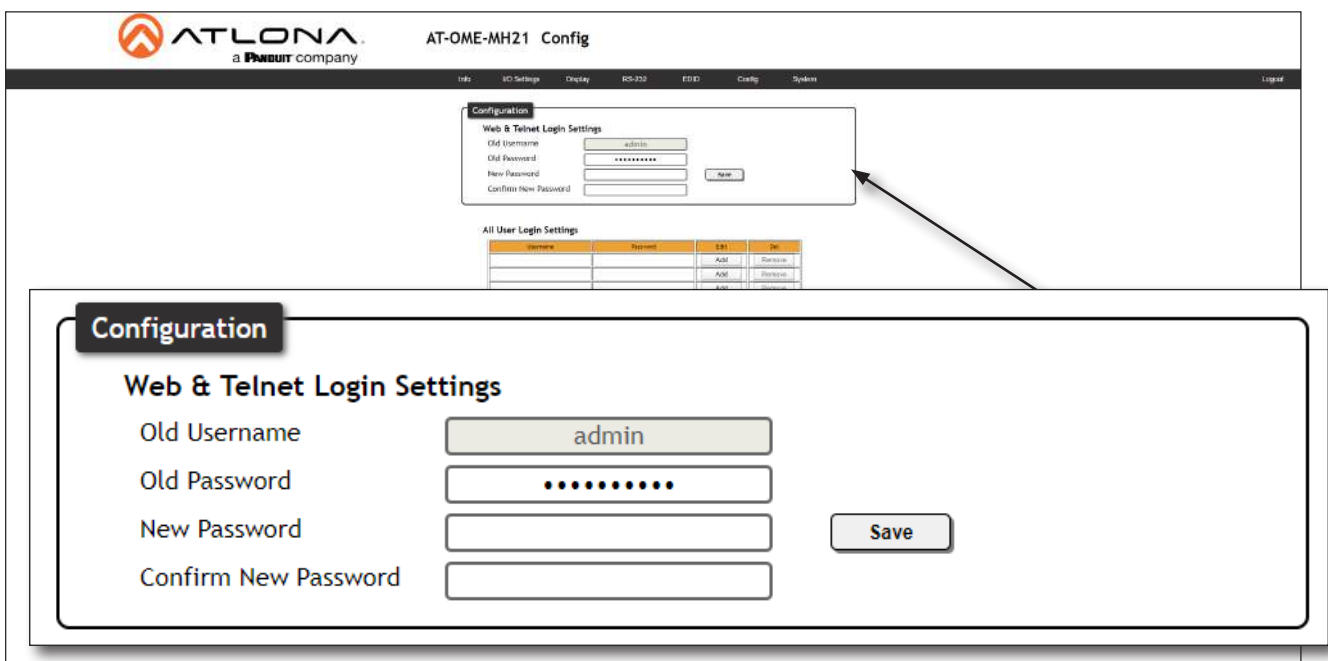

The screenshot shows the AT-OME-MH21 Config web interface. At the top, there is a navigation bar with the ATLONA logo and a 'Config' menu item. Below the navigation bar, there is a 'Configuration' section with a sub-section for 'Web & Telnet Login Settings'. This section contains four input fields: 'Old Username' (with the value 'admin'), 'Old Password' (masked with dots), 'New Password', and 'Confirm New Password'. A 'Save' button is located to the right of the 'New Password' field. A red box highlights the 'Old Password' field, and a red arrow points to it from the right.

4. Enter the new password in the **New Password** field.
5. Retype the new password in the **Confirm New Password** field.
6. Click the **Save** button to commit changes. To login with the new username, click **Logout** in the upper-right corner of the screen, then enter the new password on the **Login** page.

i **NOTE:** Password fields will always be masked for security purposes.

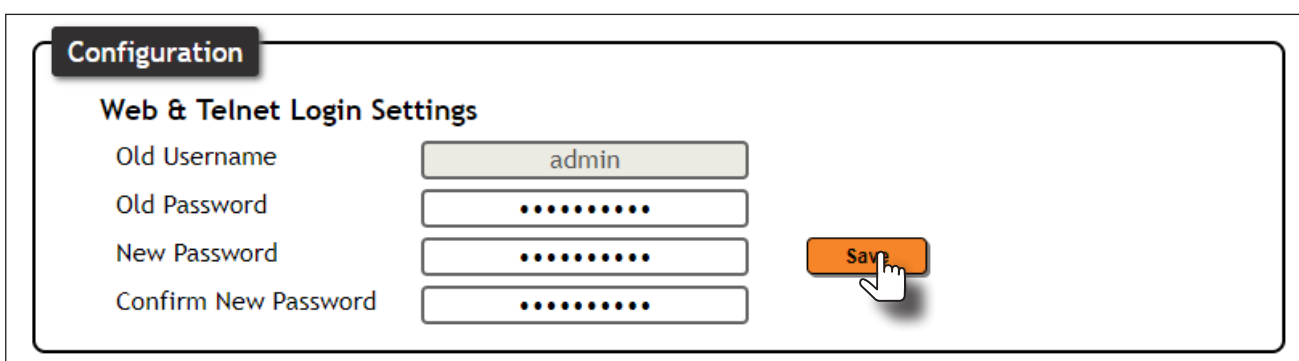

This screenshot is a zoomed-in view of the 'Web & Telnet Login Settings' form. The 'Old Username' field contains 'admin'. The 'Old Password', 'New Password', and 'Confirm New Password' fields are all masked with dots. A red box highlights the 'Save' button, and a hand cursor is shown clicking on it.

Creating and Deleting User Accounts

1. Login to the web server. Refer to [Web Server \(page 18\)](#) for more information.
2. Click **Config** in the menu bar.
3. Click the **Add** button, under the **Edit** column.

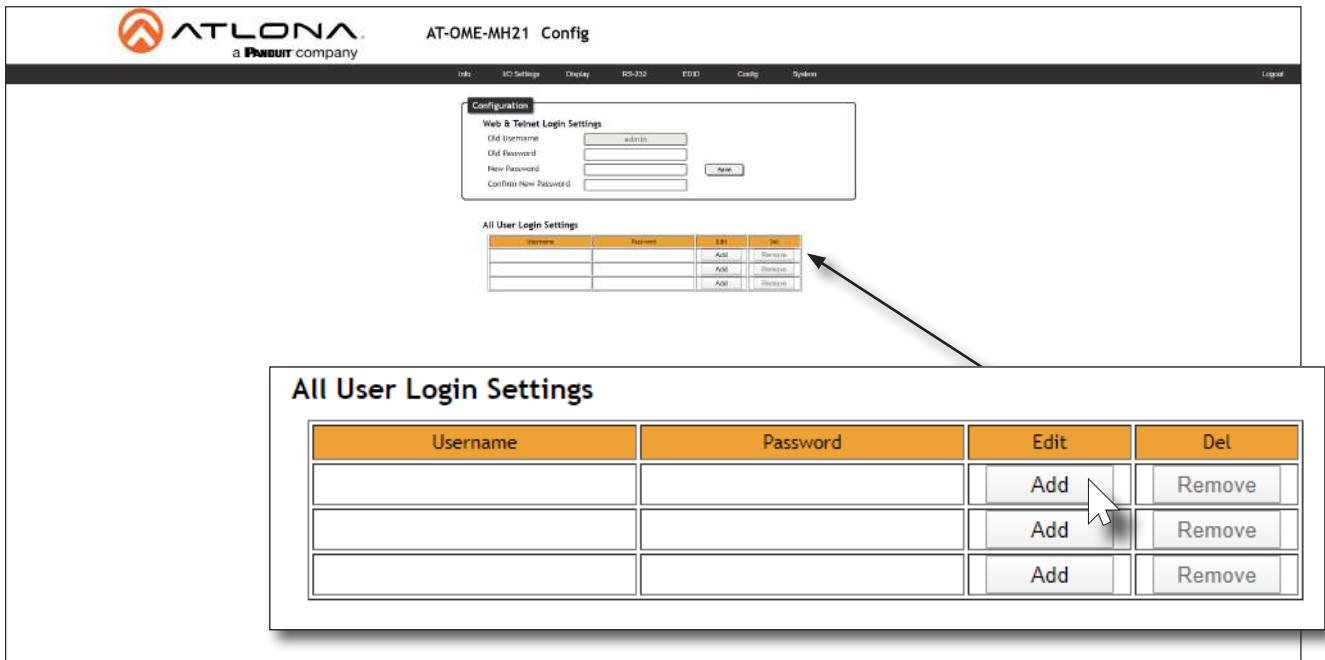

The screenshot shows the AT-OME-MH21 Config web interface. At the top, there is a navigation bar with 'Info', 'IC Settings', 'Display', 'RS-232', 'EDIT', 'Config', 'System', and 'Logout'. Below this, there are sections for 'Web & Telnet Login Settings' and 'All User Login Settings'. The 'All User Login Settings' section contains a table with the following structure:

Username	Password	Edit	Del
		Add	Remove
		Add	Remove
		Add	Remove

An arrow points to the 'Add' button in the 'Edit' column of the first row. A larger, detailed view of this table is shown below, with a mouse cursor hovering over the 'Add' button in the 'Edit' column of the first row.

Username	Password	Edit	Del
		Add	Remove
		Add	Remove
		Add	Remove

4. Enter the desired username and password in the **Username&Password Edit** dialog box.
5. Click the **Save Change** button to commit changes or click the **Cancel** button to return to the **Config** page without adding the user.



The screenshot shows the 'Username&Password Edit' dialog box. It has a title bar with a close button. Inside, there are two input fields: 'Username' with the value 'minion1' and 'Password' with the value '12345678'. At the bottom, there are two buttons: 'Save Change' and 'Cancel'. A mouse cursor is pointing at the 'Save Change' button.

Once created, the new user and the associated password will appear under the **All User Login Settings** section. To login with the new username, click **Logout** in the upper-right corner of the screen, then enter the login credentials for the user on the **Login** page.

6. To delete a user, click the **Remove** button under the **Del** column.

System Configuration

The AT-OME-MH21 / AT-OME-MH21-CP provides easy access to system configuration through the built-in web server, and is the recommended method to adjust network settings.

Getting the MAC Address

1. Login to the web server. Refer to [Web Server \(page 18\)](#) for more information.
2. Click **System** in the menu bar.
3. Locate the MAC address field, as shown below. This is the hardware address of the AT-OME-MH21 / AT-OME-MH21-CP.

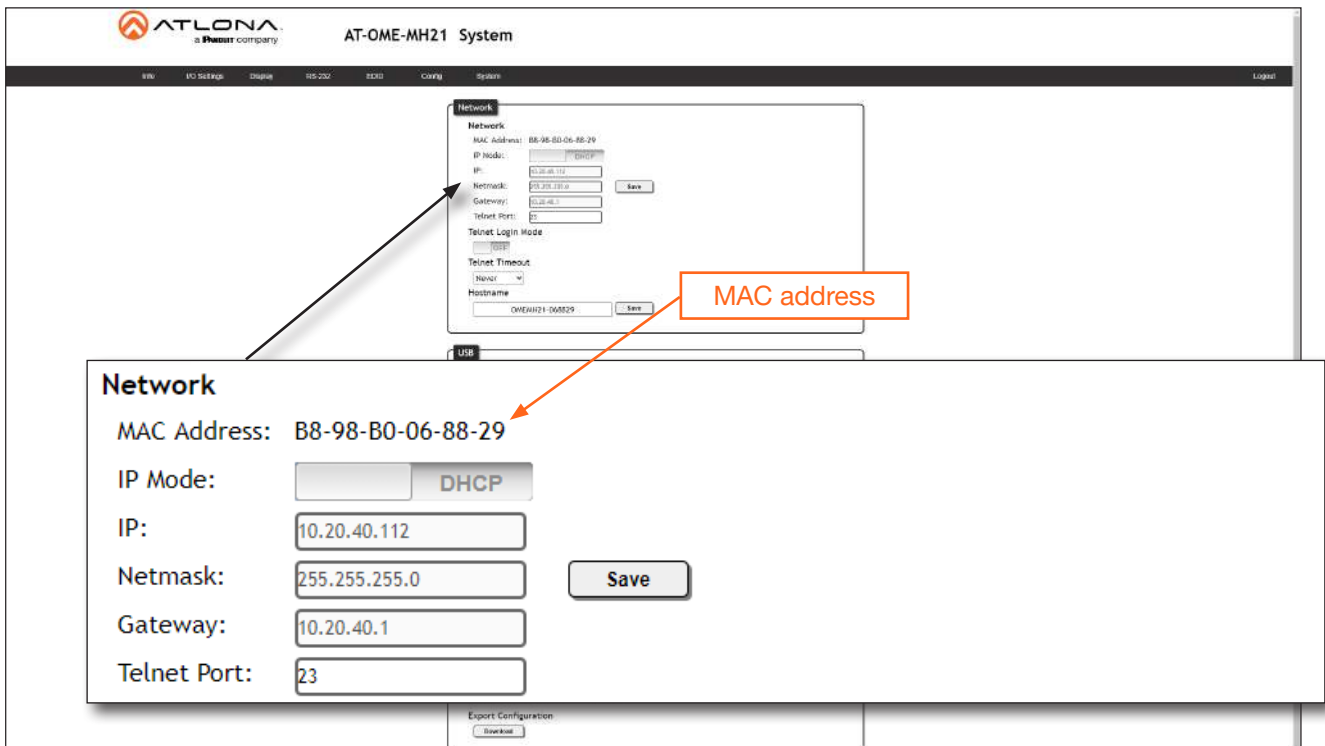

Changing the Telnet Port

Typically, the Telnet service is assigned to TCP port 23. This is the default setting for the AT-OME-MH21 / AT-OME-MH21-CP. However, depending upon the network environment, the default Telnet port can be changed.

1. Login to the web server. Refer to [Web Server \(page 18\)](#) for more information.
2. Click **System** in the menu bar.
3. Locate the **Telnet Port** field and enter the desired port in the field.
4. Click **Save** to commit changes.

Network

MAC Address: B8-98-B0-06-88-29

IP Mode: DHCP

IP:

Netmask:

Gateway:

Telnet Port:

Telnet Login Mode

When a Telnet session is request, the AT-OME-MH21 / AT-OME-MH21-CP provides the option to prompt for user credentials or bypass authentication before the Telnet session begins. This credentials prompt option can enabled or disabled. When prompting for user credentials, use the same login information required by the built-in web server.

1. Login to the web server. Refer to [Web Server \(page 18\)](#) for more information.
2. Click **System** in the menu bar.
3. Click the **Telnet Login Mode** toggle switch.
 - Set this toggle switch to **ON** to prompt for user credentials.
 - Set this toggle switch to **OFF** to bypass user credentials request.
4. Click **Save** to commit changes.

Gateway:

Telnet Port:

Telnet Login Mode

ON OFF

Telnet Timeout

Adjusting Telnet Timeout

When a Telnet session is active, the AT-OME-MH21 / AT-OME-MH21-CP can be set to monitor Telnet activity. If there is no activity within the specified time interval, the Telnet session will automatically be terminated, adding a measure of security.

1. Login to the web server. Refer to [Web Server \(page 18\)](#) for more information.
2. Click **System** in the menu bar.
3. Click the **Telnet Timeout** drop-down list and select the desired time-out interval. Values from 10 to 3600 seconds can be selected.



IMPORTANT: If **Never** is selected, then the Telnet port will stay open until the Telnet session is manually terminated.

4. Click **Save** to commit changes.

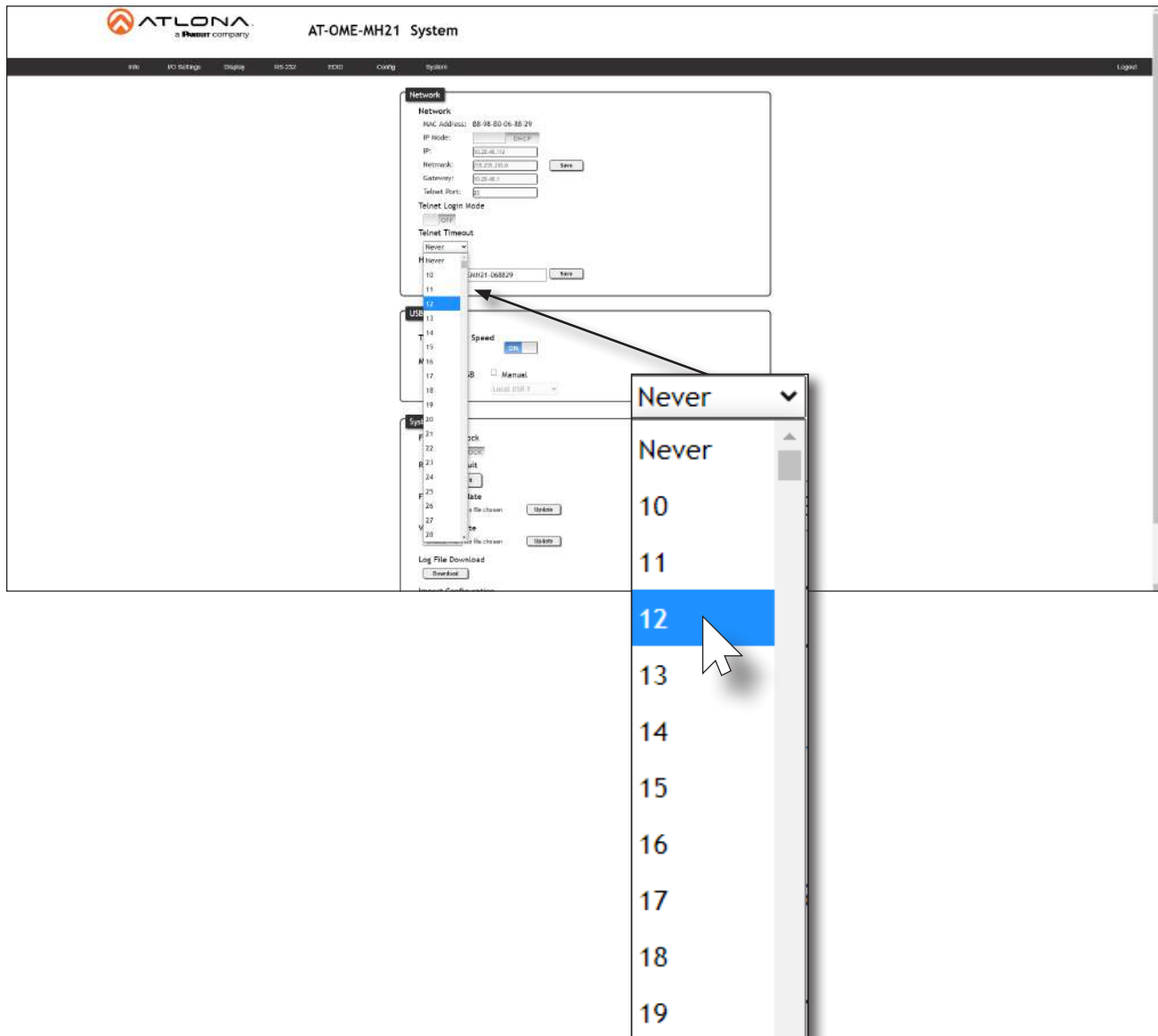

Setting the Host Name

By default, the AT-OME-MH21 / AT-OME-MH21-CP is assigned a hostname, which is constructed as follows:

OMEMH21-[last six digits of MAC address]

For example, a default hostname might look like this: OMEMH21-00021B. This value can be changed to easily identify the AT-OME-MH21 / AT-OME-MH21-CP within the Atlona Management System (AMS) or a network. If using a custom hostname, it must meet the hostname standards, defined here: <https://tools.ietf.org/html/rfc1123>

1. Login to the web server. Refer to [Web Server \(page 18\)](#) for more information.
2. Click **System** in the menu bar.
3. Click the **Hostname** field and enter the desired name.
4. Click **Save** to commit changes.

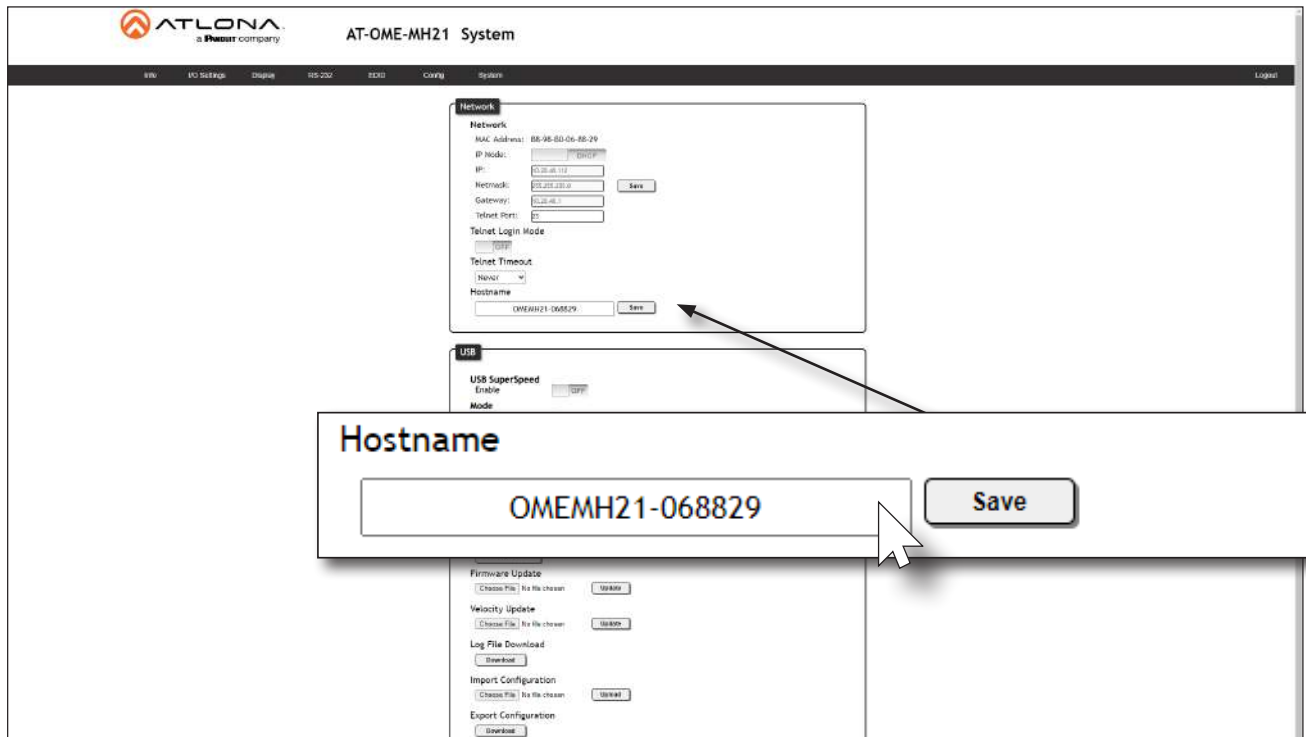

Locking / Unlocking the Front Panel

To prevent accidental pressing of the front panel buttons, the front panel buttons can be locked. This may be desirable if, for example, the AT-OME-MH21 / AT-OME-MH21-CP is installed in a rack environment. By default, the front panel buttons are unlocked.

1. Login to the web server. Refer to [Web Server \(page 18\)](#) for more information.
2. Click **System** in the menu bar.
3. Click the **Front Panel Lock** toggle switch to lock the buttons on the front panel. When the front panel is locked, the toggle switch will display the **LOCK** setting.

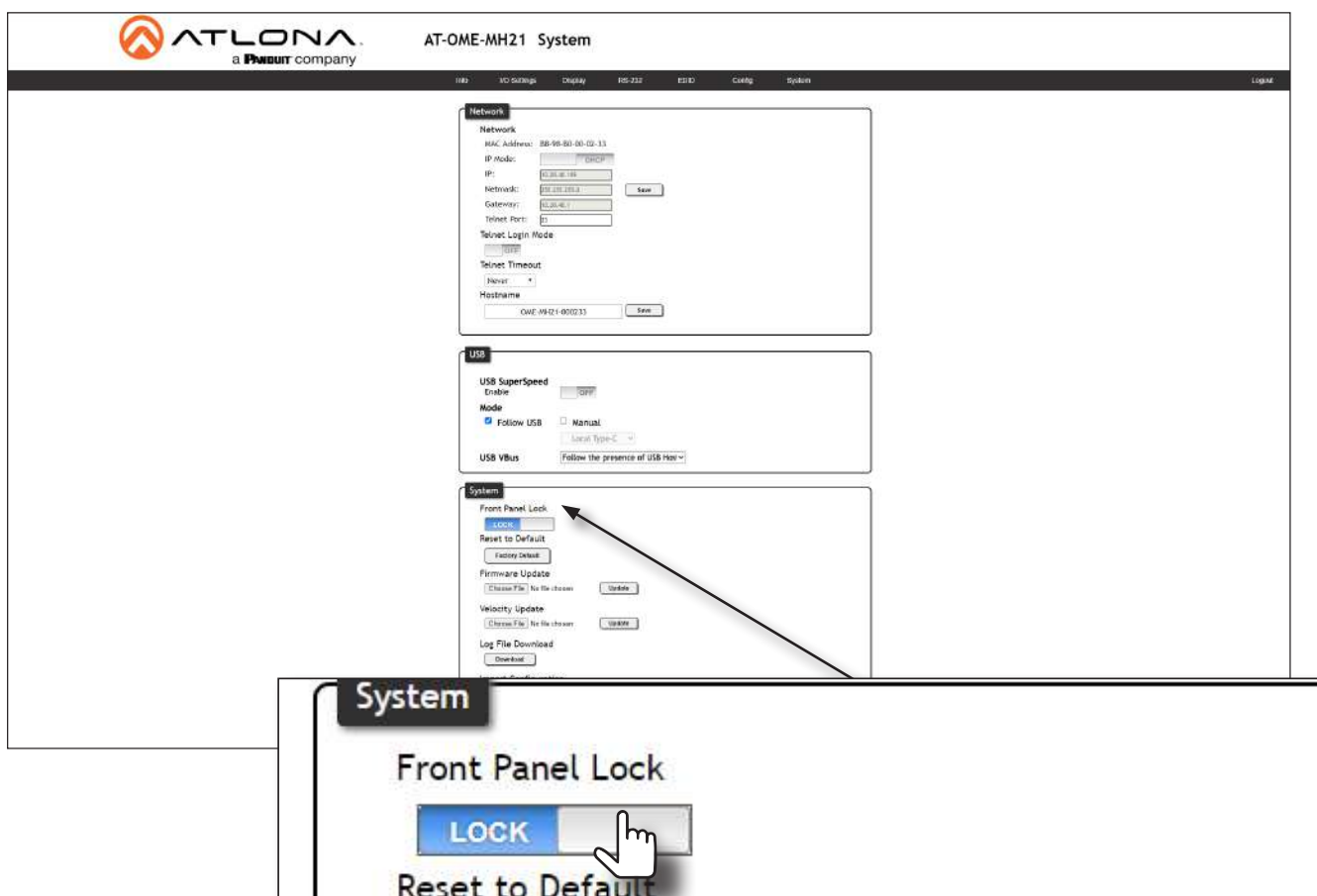

4. To unlock the front panel, click the **Front Panel Lock** toggle switch again to set it to **UNLOCK**.

Resetting to Factory-Default Settings

The following procedure will reset the AT-OME-MH21 / AT-OME-MH21-CP to factory-default settings. The network IP mode will be set to DHCP mode.

1. Login to the web server. Refer to [Web Server \(page 18\)](#) for more information.
2. Click **System** in the menu bar.
3. Click the **Factory Default** button.

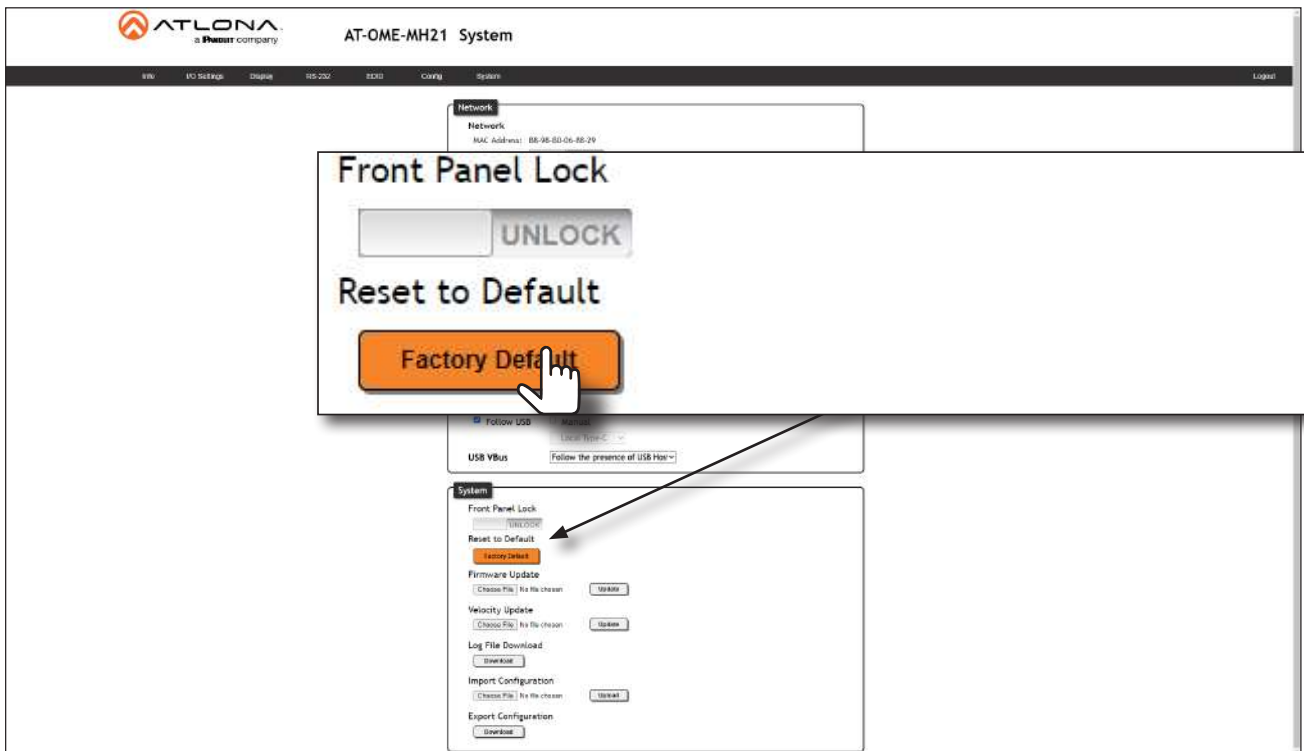

4. The following message will be displayed at the top of the screen. Click **OK** to continue with the factory-default reset procedure. Click **Cancel** to abort the process.

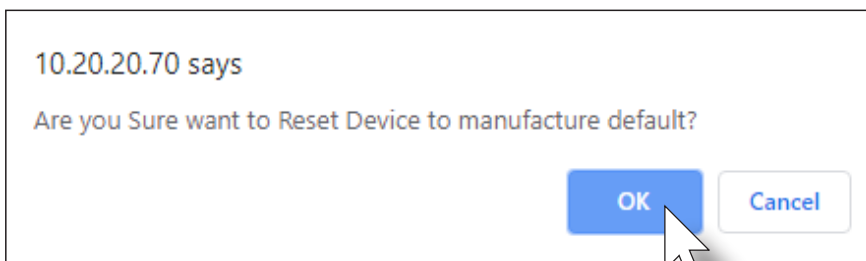

5. Once the factory-default process is complete, the web server **Login** screen will be displayed.
6. The reset process is complete.

Downloading System Configuration

The AT-OME-MH21 / AT-OME-MH21-CP allows the current system configuration to be downloaded to the connected computer, in .json format. Multiple configurations can be saved and then restored at any time. Refer to [Restoring System Configuration \(page 40\)](#) for more information.

1. Login to the web server. Refer to [Web Server \(page 18\)](#) for more information.
2. Click **System** in the menu bar.
3. Click the **Download** button.

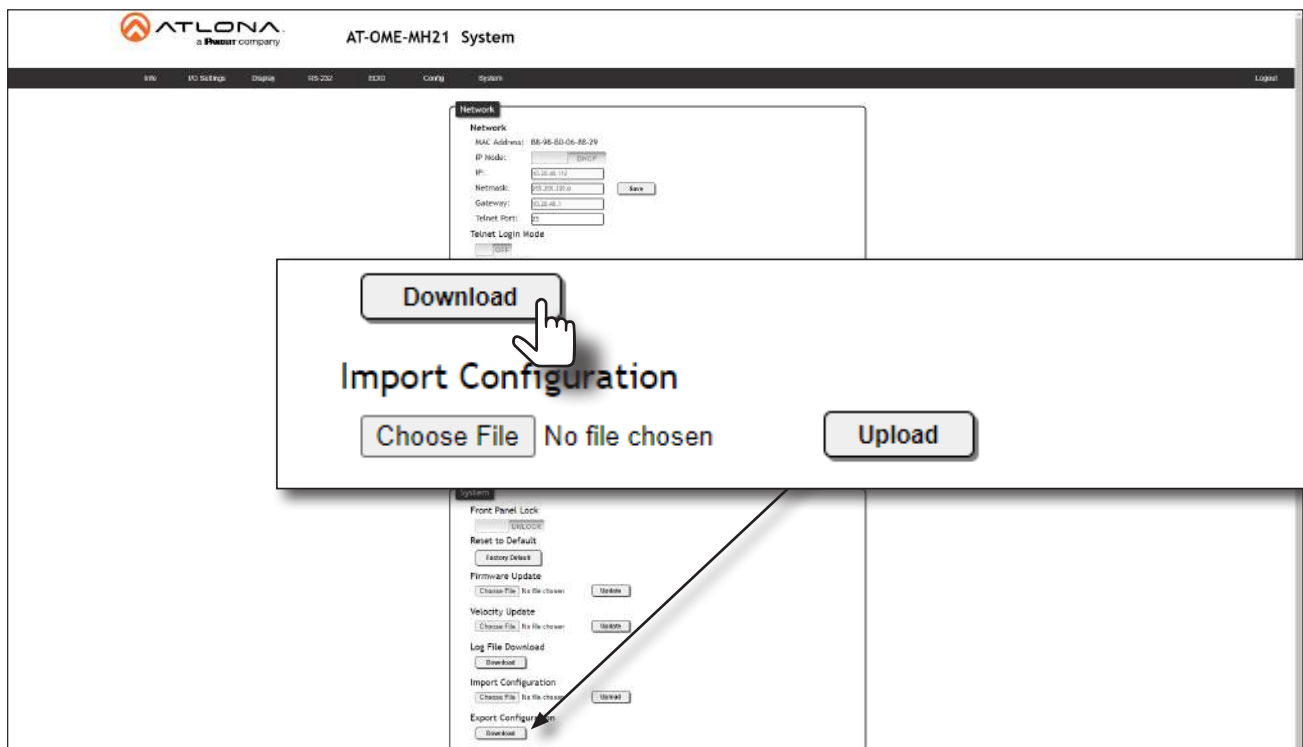

4. After a few moments, the **Save As** dialog will be displayed. The filename name field will be automatically be filled in with the a default filename, similar to: AT-OME-MH21_OMEMH21-068829.json. The filename can be changed, but the file extension of .json must exist. The OMEMH21-068829 portion of the filename is the unit host name.
5. Click the **Save** button to save the file to the desired folder on the computer.

Restoring System Configuration

Once a system configuration has been saved as an .json file, the file can be uploaded to the AT-OME-MH21 / AT-OME-MH21-CP, allowing a system configuration to be restored. Both the **Export Configuration** and **Import Configuration** feature are useful for saving and loading different configurations and/or to provide a backup, in the unlikely event of a system failure. When a system configuration file is uploaded, it will overwrite the current settings.



IMPORTANT: IP Mode information is stored as part of the configuration file. Therefore, caution should be exercised when sharing configuration files between multiple AT-OME-MH21 / AT-OME-MH21-CP units. If the unit is set to *static* IP mode, then restoring multiple units with the same configuration file will result in the same IP address being shared between multiple units, causing an IP conflict on the network.

1. Login to the web server. Refer to [Web Server \(page 18\)](#) for more information.
2. Click **System** in the menu bar.
3. Click the **Choose File** button, under **Import Configuration**.

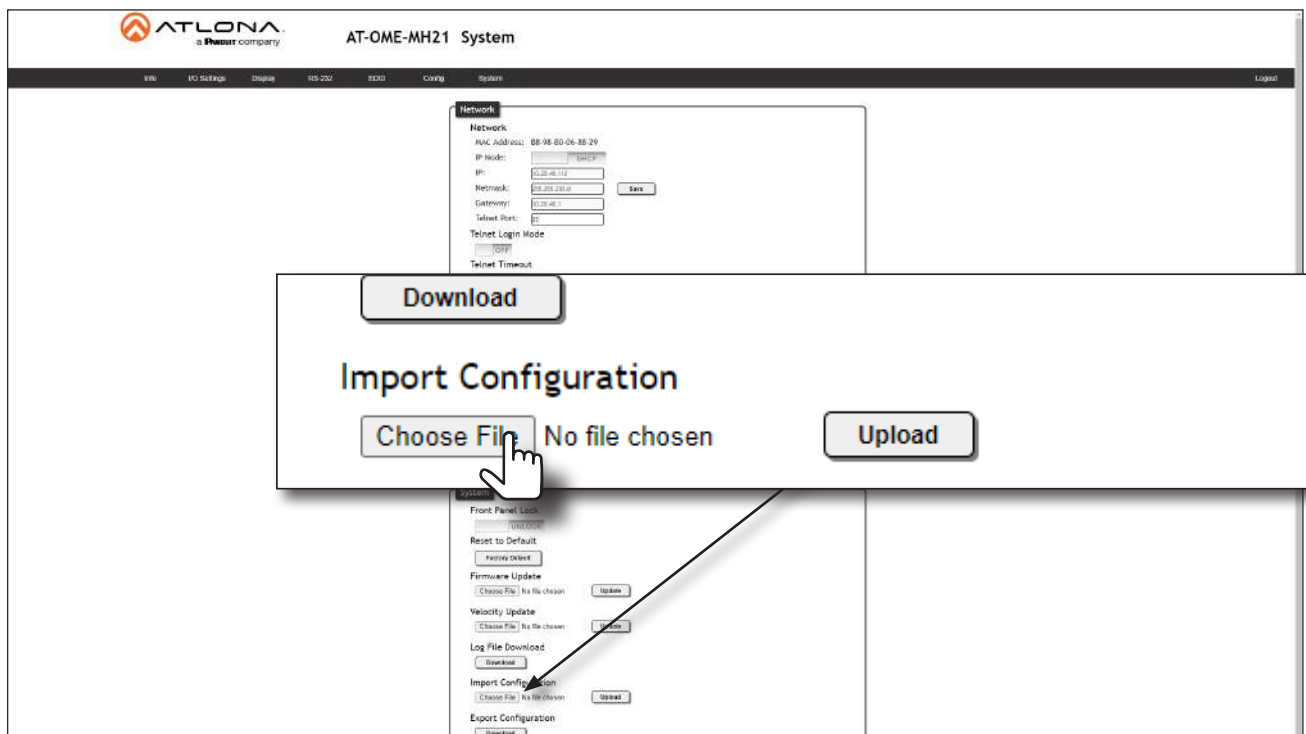

4. The **Open** dialog will be displayed. Select the desired system configuration file. Once the file is selected, the selected filename will appear next to the **Choose File** button.
5. Click the **Upload** button to upload the configuration file to the AT-OME-MH21 / AT-OME-MH21-CP. The following warning message will be displayed:

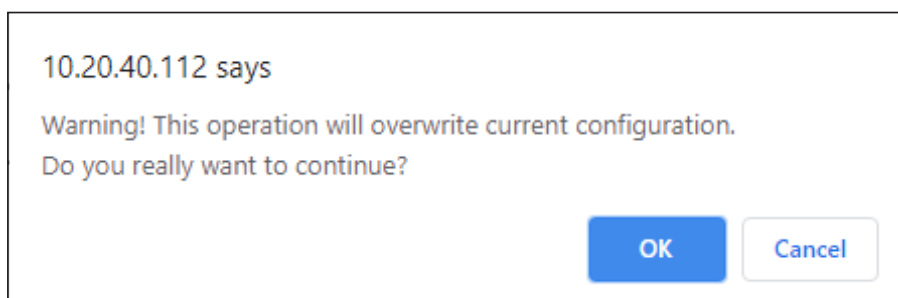

Device Operation

6. Click the **OK** button to continue or click **Cancel** to abort the operation.
7. One the upload has started, a progress message will be displaying the restore process.
8. The restoration process is complete.

USB Modes

USB-C SuperSpeed Mode

The USB-C port can be set to enable or disable USB SS (Super Speed) mode. USB SS mode is enabled by default. Refer to the table below for details.

USB SuperSpeed	Maximum Resolution	Maximum Data Rate
ON (enabled)	4096x2048 @ 30 Hz	USB 3.0 data up to 5Gb/s
OFF (disabled)	4096x2048 @ 60 Hz	USB 2.0 data up to 480 Mb/s

1. Login to the web server. Refer to [Web Server \(page 18\)](#) for more information.
2. Click **System** in the menu bar.
3. Click the **Enable** toggle, under **USB SuperSpeed**, to the **ON** position to enable USB SS mode. Click this toggle switch to the **OFF** position to disable USB SS mode.

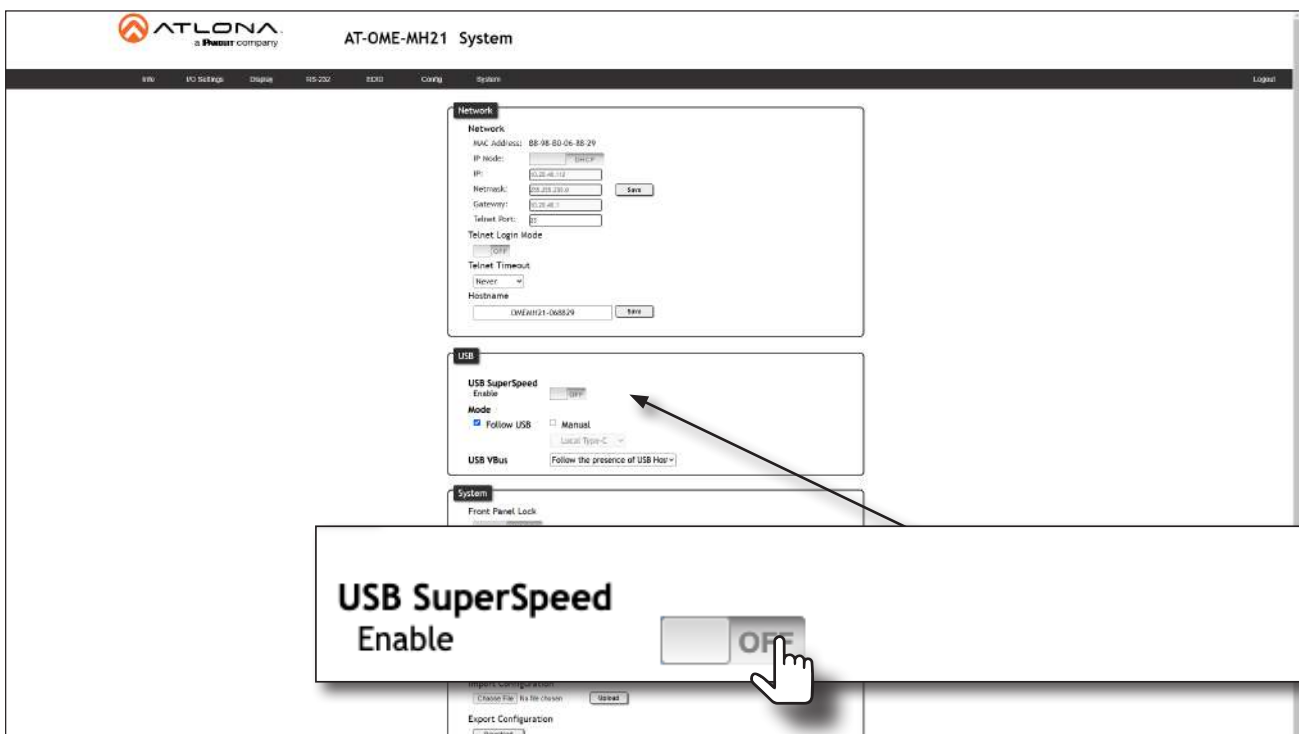

Follow USB Mode

This is the default mode and functions similar to auto-switching for video. In this mode, the AT-OME-MH21 / AT-OME-MH21-CP will detect which USB ports are connected to a host device. If both USB host ports are connected to host devices, then the AT-OME-MH21 / AT-OME-MH21-CP will set the last-connected USB host device as the “active” USB host. Use the procedure below to enable Follow USB mode.

1. Connect the host computers to the USB host ports, as desired. Note that it is not required that both the HOST USB and USB-C ports be connected to host devices.

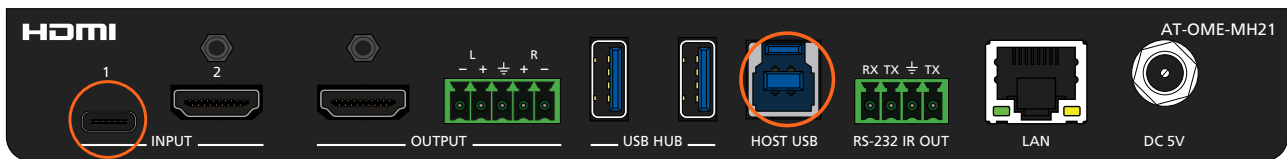

2. Login to the web server. Refer to [Web Server \(page 18\)](#) for more information.
3. Click **System** in the menu bar.
4. The **Follow USB** check box should already be checkmarked, indicating that the feature is enabled.

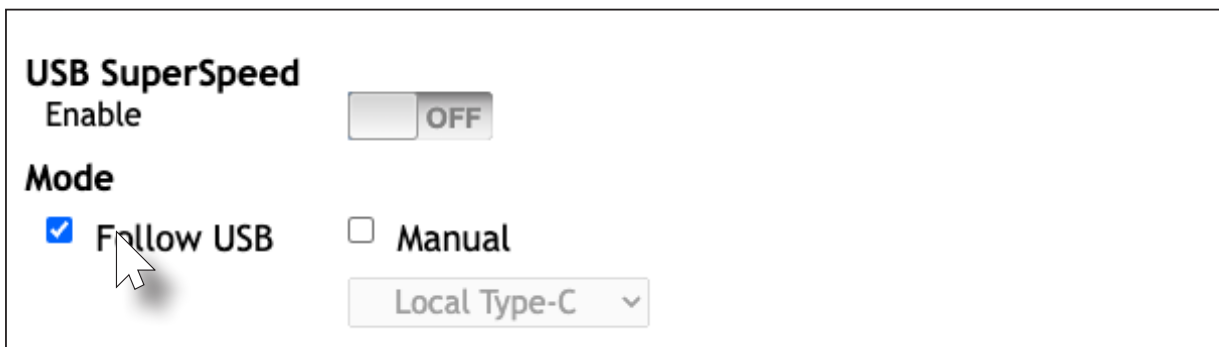

Once set to **Follow USB** mode, the AT-OME-MH21 / AT-OME-MH21-CP will exhibit the following behavior:

- If only one USB host port is connected, then the AT-OME-MH21 / AT-OME-MH21-CP will use the USB host device connected to that port.
- If an another USB host device is connected to the vacant USB port, then the AT-OME-MH21 / AT-OME-MH21-CP will automatically switch to that USB host device.
- If *both* **HOST USB** and **USB-C** ports are connected, then the AT-OME-MH21 / AT-OME-MH21-CP will switch to the USB port that was connected *last*.
- If *both* **HOST USB** and **USB-C** host ports are connected, and one USB host port is disconnected, then the AT-OME-MH21 / AT-OME-MH21-CP will automatically switch to the opposite USB host port.

Manual Mode

This mode provides manual selection of the USB host port to be used.

1. Connect the host computers to the USB host ports, as desired. Note that it is not required that both USB host ports be connected to host devices.

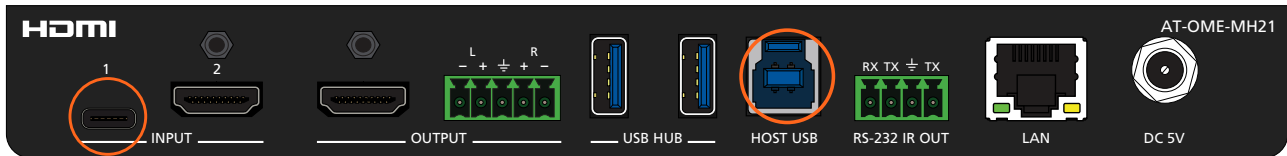

2. Login to the web server. Refer to [Web Server \(page 18\)](#) for more information.
3. Click **System** in the menu bar.
4. Click the **Manual** check box.
5. Click the drop-down list, under the **Manual** check box and select the desired USB port.

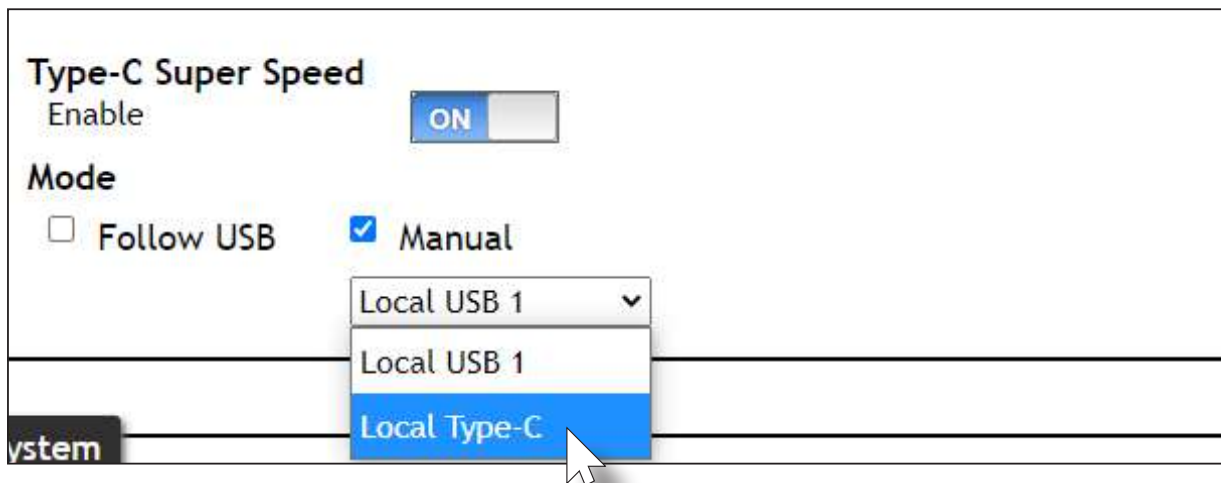

6. Manual USB configuration is complete.

Configuration and Management Interfaces

Web Server

Info Page

The **Info** page provides various information about the AT-OME-MH21 / AT-OME-MH21-CP, including software version and video information.

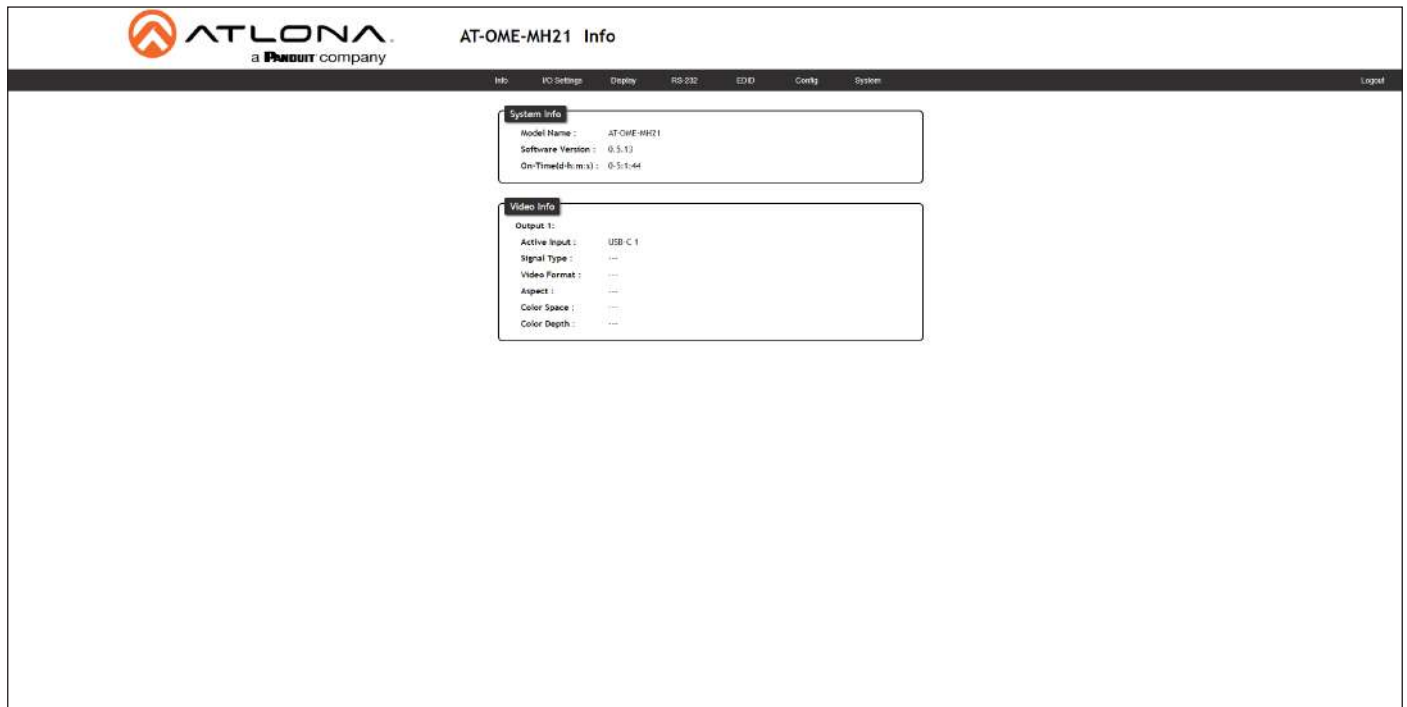

Model Name

The model SKU of this product.

Software Version

The version of firmware that the AT-OME-MH21 / AT-OME-MH21-CP is running. Always make sure to check the AT-OME-MH21 / AT-OME-MH21-CP product page, on the Atlona web site, for the latest version of firmware.

On-Time(d-h:m:s)

Displays how long the system has been powered since the last reboot/reset.

Active Input

The currently selected (active) input.

Signal Type

The type of input signal.

Video Format

The input resolution of the source device.

Aspect

Aspect ratio of the input signal.

Color Space

Displays the color space and chroma sub-sampling of the input signal.

Color Depth

The color depth of the input signal.

Configuration and Management Interfaces

I/O Settings Page



Auto Switch

Click this toggle switch to enable or disable auto-switching. When enabled, the AT-OME-MH21 / AT-OME-MH21-CP will automatically switch to the another input, if the signal is disrupted on the currently active input.

Input Selection

Click this drop-down list to manually select the desired input.

Input	Description
USB-C 1	Sets INPUT 1 as the active input.
HDMI 2	Sets INPUT 2 as the active input.
A/V Mute	Mutes both audio and video on the output.

Audio

Manages audio settings for inputs and outputs.

- **HDMI**
Set this toggle to the **ON** position to mute the audio on the output. The default setting is **OFF**.
- **Analog**
Set this toggle to the **ON** position to mute the audio on the **ANALOG** output. The default setting is **OFF**.

Scaler

Click this toggle switch to enable or disable the scaler pass-through feature. When set to the **ON** position, 4K content will be down-scaled to 1080p. When set to the **OFF** position, the output resolution / timing will be the same as the input source. The default setting is **ON**.

Configuration and Management Interfaces

HDMI Output +5V

Sets the +5V pin on the HDMI connector to the desired setting.

Setting	Description
On When Signal Present	Allows the +5V pin on the HDMI output to toggle, based on the presence of an input video signal.
Always On	Forces the +5V pin on the HDMI output to “high” (always on).

HDCP

Each input provides control of how HDCP content is handled. Some source devices will send HDCP content if an HDCP-compliant display (sink) is detected. However, there may be applications where sending HDCP content is not desired. Setting the port to the **OFF** position, will instruct the source to send non-HDCP content to the display. Note that not all sources have this capability.



NOTE: Setting this feature to **OFF**, for any source, does *not* provide decryption of HDCP content to non-HDCP compliant sink devices. Sources such as Mac® computers and the Sony PlayStation® will *always* transmit HDCP content.

- **ON**
When set to **ON**, the source will have the ability to transmit HDCP content to the AT-OME-MH21 / AT-OME-MH21-CP.
- **OFF**
When set to **OFF**, non-HDCP content will be transmitted (if possible) to the AT-OME-MH21 / AT-OME-MH21-CP.

Configuration and Management Interfaces

Display Page

This page provides controls for CEC, device timers, and configuration for controlling external devices.

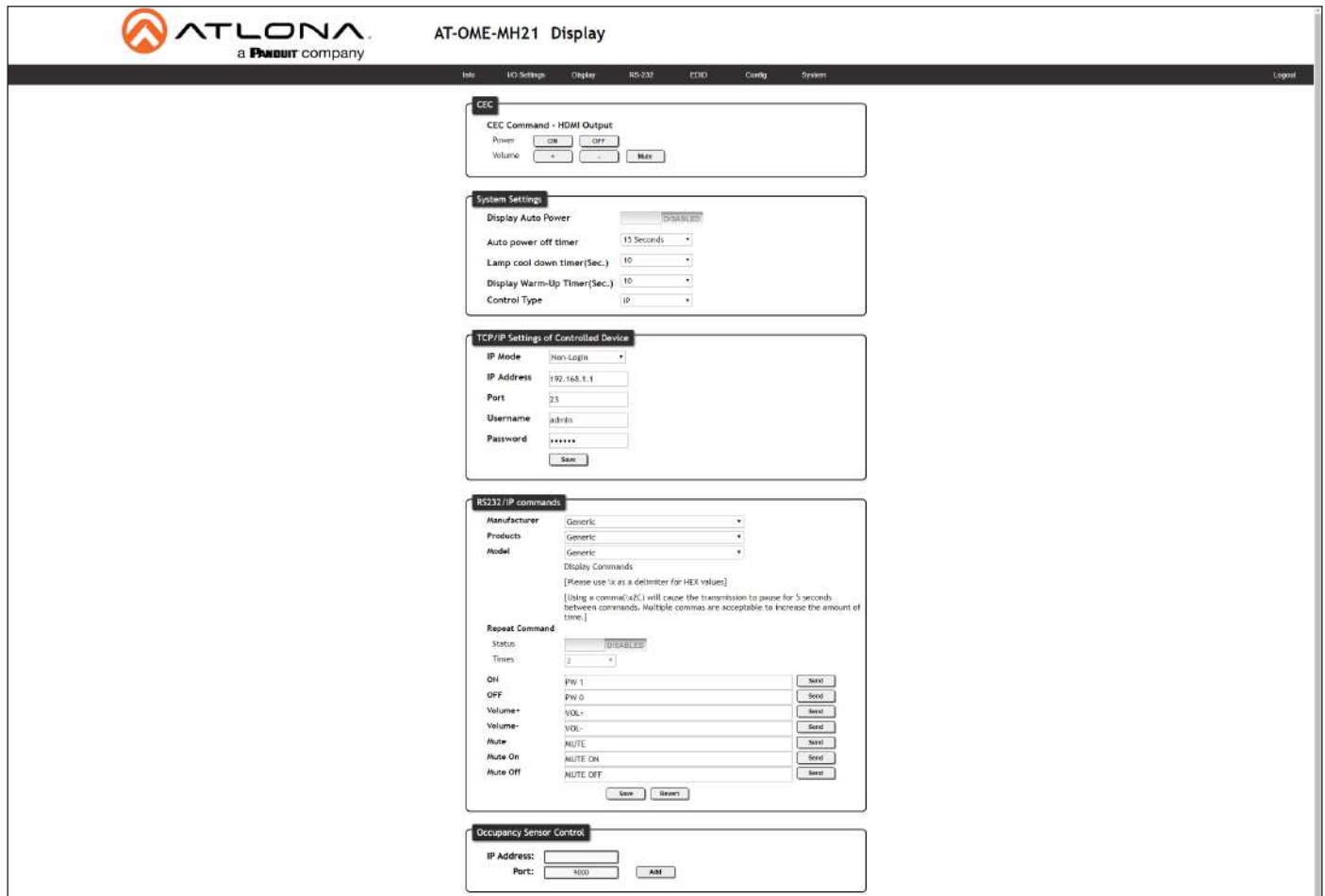

CEC Command - HDMI Output

- Power**
 Click the **ON** button to send the power-on command to the display device. Click the **OFF** button to toggle the power state to off.
- Volume**
 Click the + or - button to increase or decrease the output volume, respectively. Click the **Mute** button to mute the audio.

Consumer Electronics Control (CEC) Note: Atlona has confirmed proper CEC functionality with several current models of Samsung, Panasonic, and Sony displays. However, it is not guaranteed that CEC will work with all displays. Many manufacturers do not support the CEC “off” command, and older displays use proprietary commands. Atlona only supports displays that use the CEC command structure defined in HDMI 1.2a. It is recommended that dealers request an evaluation product from Atlona, before designing a system using the CEC protocol. If this is not possible, then other control methods will need to be considered, in order to control displays using Atlona products.

Configuration and Management Interfaces

Display Auto Power On

Set this toggle to **ENABLED** to allow the AT-OME-MH21 / AT-OME-MH21-CP to send the power-on command to the display when an A/V signal is detected. When the AV signal is no longer present, the AT-OME-MH21 / AT-OME-MH21-CP will send the power-off command to the display. If this feature is not desired, then set to **DISABLED**. This feature is disabled by default.

Auto power off timer

Sets the time interval before the command to power-off the display is sent, when an A/V signal is no longer present. The default value is 15 seconds. Available values are 5 seconds to 1 hour.

Lamp cool down timer (Sec.)

Sets the projector lamp cool-down timer, in seconds. This value specifies the time interval that must elapse, after the display control “off” command is sent, before the display “power on” command can be sent. This feature is used to prevent the projector from missing a “power on” command while the lamps are cooling. Available values are 10 to 300 seconds. The default setting is 10 seconds.

Display Warm-Up Timer (Sec.)

Sets the projector lamp warm-up timer, in seconds. During the warm-up interval, the AT-OME-MH21 / AT-OME-MH21-CP will not start the auto power-off timer. This value specifies the time interval that must elapse, after the display control “on” command is sent, before the display “power off” command can be sent. This feature is used to prevent a “power off” command from being sent while the lamps are warming up. Available values are 10 to 300 seconds. The default value is 10 seconds.

Control Type

Sets the control protocol for the connected display. Click this drop-down to select the control type. Available settings are **RS-232**, **IP**, **CEC**, and **IR**. By default, CEC is selected for control of the display. When IP, RS-232, or IR is selected, more fields are displayed.

TCP/IP Settings of Control Device

This window group is only available if the **Control Type** drop-down list is set to **IP**.

IP Mode

Click this drop-down list to select the login mode.

Setting	Description
Non-login	Does not require a username and password when using TCP/IP to control the display.
Login	Requires a username and password to control the display through TCP/IP.

IP Address

Enter the IP address of the device in this field.

Port

Enter the listening port of the device in this field.

Username

Enter the username for login. If the **IP Mode** is set to **Non-Login**, then this information will not be required.

Password

Enter the password for login. If the **IP Mode** is set to **Non-Login**, then this information will not be required.

Save

Click this button to save all changes in this window group.

Configuration and Management Interfaces

RS-232/IP commands

This section is only available when the **Control Type** is set to either **RS-232** or **IP**.

Manufacturer

Click this drop-down list to select the display manufacturer. If the display device being controlled is not in this list, then select **Generic** and enter the commands manually.

Generic	Hitachi	Qomo
Acer	Infocus	Samsung
Barco	LG	Sharp
Benq	NEC	Sony
Canon	Optima	Toshiba
Casio	Panasonic	ViewSonic
Eiki	Pjlink	Vivitek
Epson	Planar	

Products

Click this drop-down list to select the product. The options available within this drop-down list are dependent upon the selected value in the **Manufacturer** drop-down list.

Model

Click this drop-down list to select the model. The options available within this drop-down list are dependent upon the selected value in the **Products** drop-down list.

Repeat Command

- **Status**

Click this toggle switch to set to **ENABLE** or **DISABLED**. Enabling this feature will re-send the command. Specify the number of times that the command is transmitted by setting the **Times** value. This feature is set to **DISABLED** by default.

- **Times**

Click this drop-down list to specify the number of times the command is sent. When the **Status** toggle switch is set to **ENABLE**, the default number of times is set to 2.

ON, OFF, Volume+, Volume-, Mute, Mute on, Mute off

These fields will need to be populated with the correct strings (either hex or ASCII format) for each function, which control the display device. If hexadecimal values are used, then use the `/x` delimiter at the end of the command string.

Save

Click this button to commit changes.

Revert

Click this button to undo changes to any pre-configured strings.

Configuration and Management Interfaces

IR commands

This section is only available when the **Control Type** is set to **IR**.



NOTE: Manufacturer IR commands and Pronto codes are supported.

Manufacturer

Click this drop-down list to select the display manufacturer. Over 350 manufacturers are supported. If the display device being controlled is not in this list, then select **Generic** and enter the commands manually.

Products

Click this drop-down list to select the product. The options available within this drop-down list are dependent upon the selected value in the **Manufacturer** drop-down list.

Model

Click this drop-down list to select the model. The options available within this drop-down list are dependent upon the selected value in the **Products** drop-down list.

ON, OFF, Volume+, Volume-, Mute, Mute on, Mute off

These fields will need to be populated with the correct strings (either hex or ASCII format) for each function, which control the display device. If hexadecimal values are used, then use the /x delimiter at the end of the command string.

Save

Click this button to commit changes.

Revert

Click this button to undo changes to any pre-configured strings.

Occupancy Sensor Control

The AT-OME-MH21 / AT-OME-MH21-CP supports the AT-OCS-900N occupancy sensor. This feature is supported on firmware version 1.0.5 or later. Refer to [Integration with the AT-OCS-900N \(page 61\)](#) for instructions on connecting to the occupancy sensor.

IP Address

Enter the IP address of the AT-OCS-900N in this field.

Port

The port number used to communicate with the AT-OCS-900N.

Add

Click this button to add the AT-OCS-900N to the AT-OME-MH21 / AT-OME-MH21-CP. Up to three occupancy sensors are supported.

Configuration and Management Interfaces

RS-232 Page

This page provides settings for local RS-232 control.

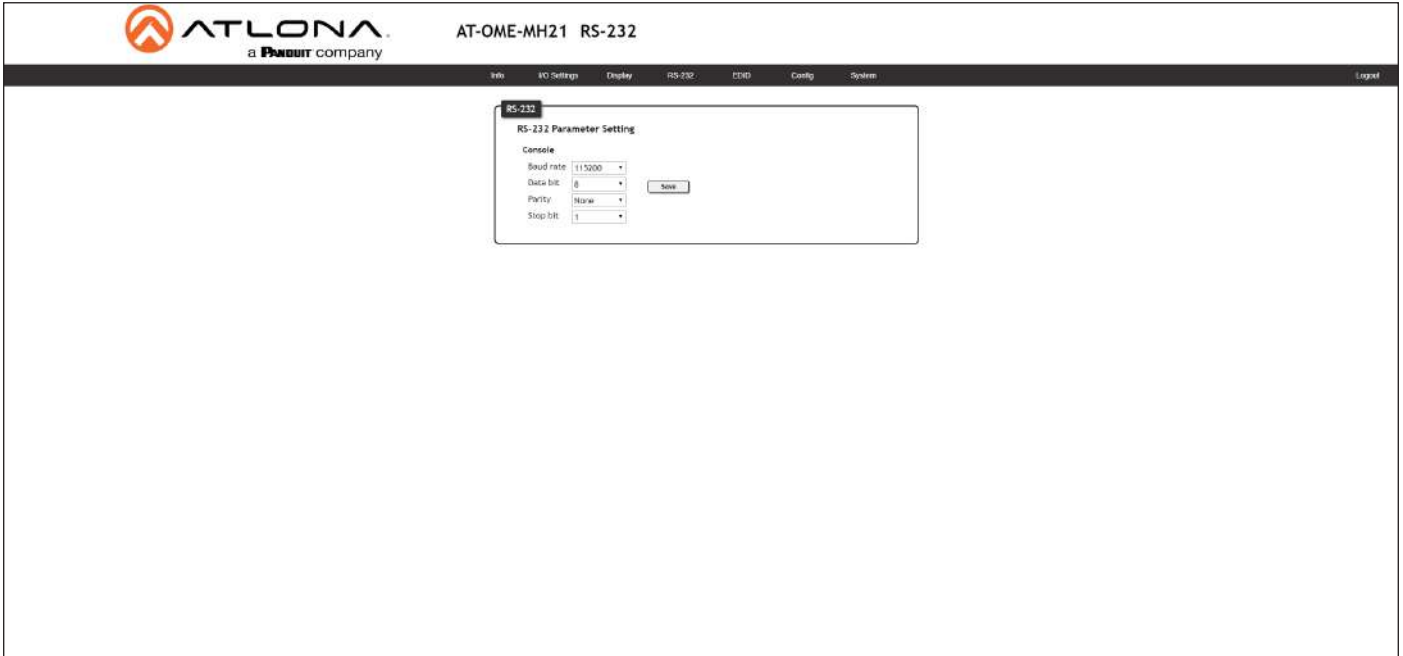

RS-232 Parameter Setting

RS-232 settings for local or HDBaseT RS-232 control.

- **RS232 Console**

Sets the RS-232 port settings used for local control by a third-party control system.

Setting	Description
Baud rate	Sets the baud rate. The following options are available: 2400, 9600, 19200, 38400, 57600, 115200.
Data bit	Sets the number of data bits used to represent each character of data. The following options are available: 7 or 8.
Parity	Sets the parity bit, which can be included with each character to detect errors during the transmission of data. The following options are available: None, Odd, or Even.
Stop bit	Sets the stop bit. Stop bits are sent at the end of each character, allowing the client to detect the end of a character stream. The following options are available: 1 or 2.

- **Save**

Click this button to commit all changes.

Configuration and Management Interfaces

EDID Page

This page provides controls for selecting and storing EDID data. Refer to [EDID Management \(page 26\)](#) for more information.

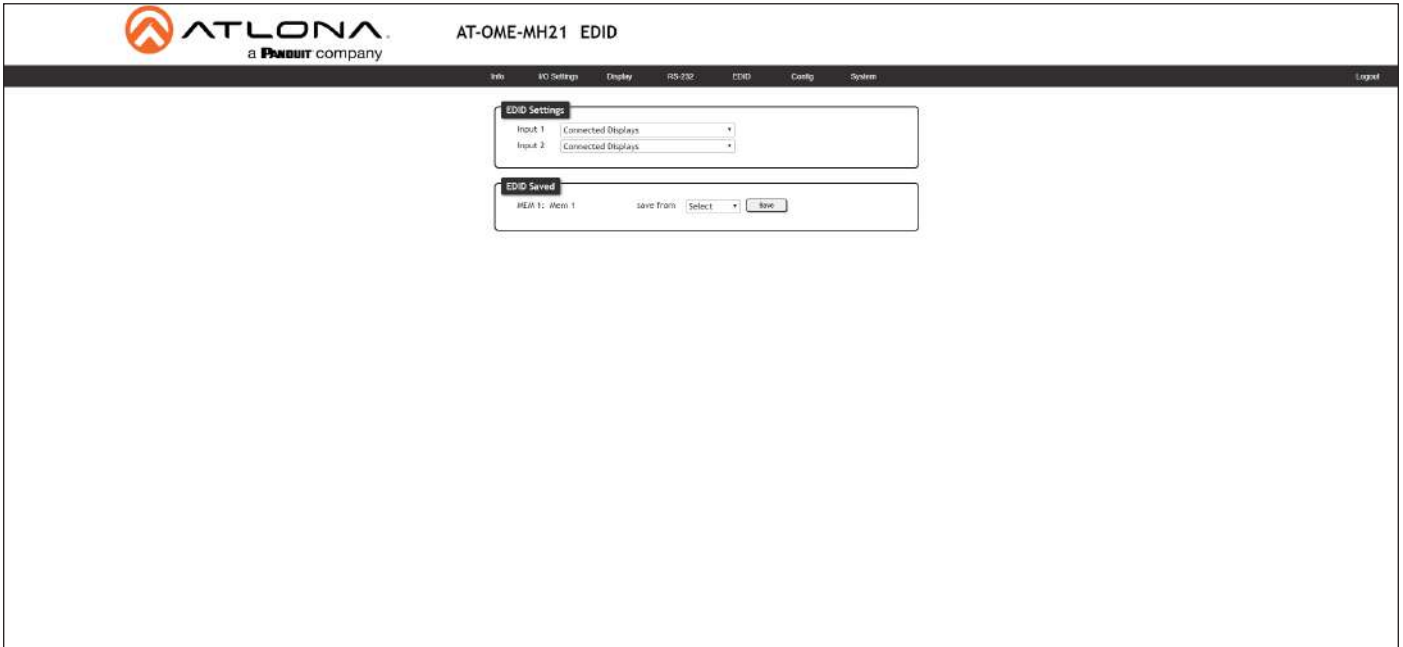

EDID Settings

Click these drop-down lists to select the desired EDID to be used for each input. The following EDID presets are available. When selecting an EDID, make sure that the display/sink device is capable of supporting the resolution/timing. If the sink device is not able to support a feature, then the source will not be displayed. Selecting the **Connected Displays** EDID will provide the most compatible settings for most displays. In addition, three memory locations are available for storing captured EDID data. If an EDID is stored in a memory location, it will also be added to the list available EDID selections.

EDID Preset	
Connected Displays	The default setting; uses the EDID of the connected display
ATL 5120x2160	5120 x 2160 @ 30 Hz with two-channel audio support.
ATL 3840x2160P60 2CH, HDR	3840 x 2160 @ 60 Hz with two-channel audio and HDR support
ATL 3440x1440 2CH	3440 x 1440 @ 50 Hz with two-channel audio support.
ATL 2560x1080 2CH	2560 x 1080 @ 60 Hz with two-channel audio support.
ATL 1920x1200 2CH	1920 x 1200 @ 60 Hz with two-channel audio support.
ATL 1920x1080P 2CH	1920 x 1080 @ 60 Hz with two-channel audio support.
ATL 1366x768 PCM	1366 x 768 @ 60 Hz with two-channel audio support.
ATL 1280x800 PCM	1280 x 800 @ 60 Hz with two-channel audio support.
ATL 1280x720 PCM	1280 x 720 @ 60 Hz with two-channel audio support.
ATL 1024x768 PCM	1024 x 768 @ 60 Hz with two-channel audio support.
Mem 1	EDID memory storage

EDID Saved

The AT-OME-MH21 / AT-OME-MH21-CP provides one memory location for storing captured EDID data. Click this drop-down lists to select and store the external EDID.

Configuration and Management Interfaces

Config Page

The **Config** page provides management of the administrator password. The administrator username (“admin”) cannot be changed. Refer to [User Management \(page 31\)](#) for more information.

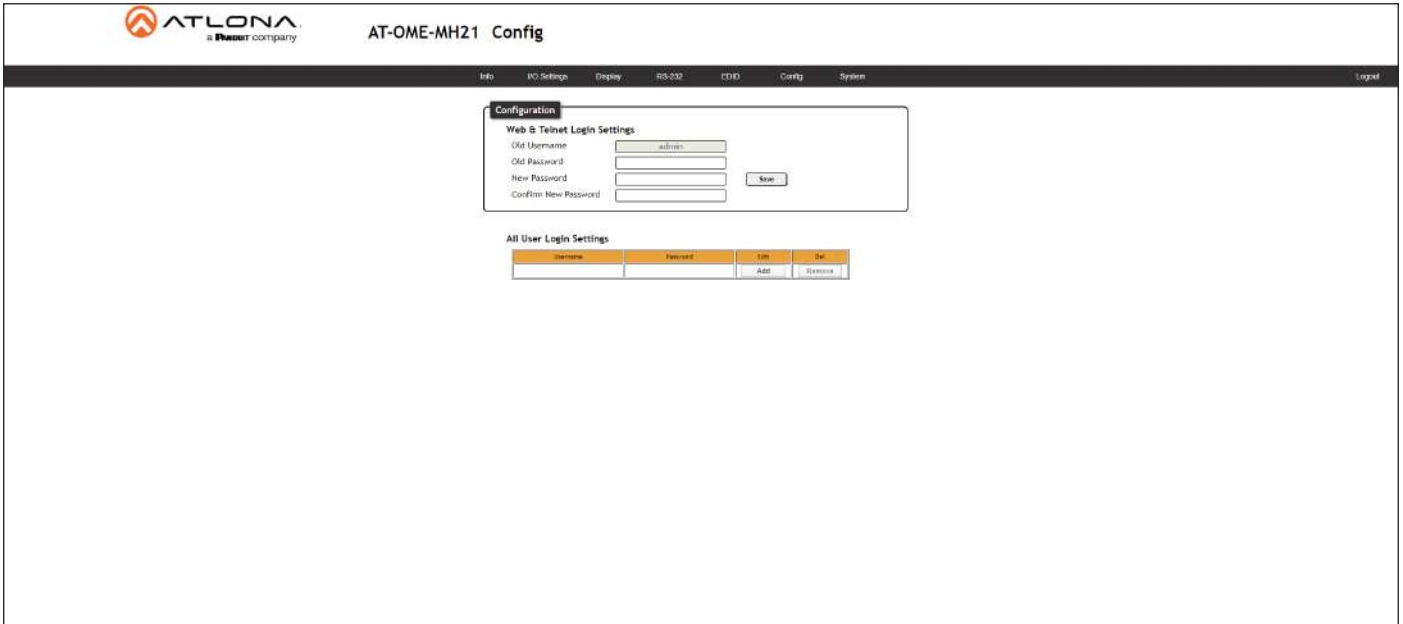

The screenshot shows the AT-OME-MH21 Config page. The top navigation bar includes links for Info, I/O Settings, Deploy, RS-232, TDD, Config, and System. The main content area is titled "Configuration" and contains two sections:

Web & Telnet Login Settings:

- Old Username:
- Old Password:
- New Password:
- Confirm New Password:
- Save button

All User Login Settings:

Username	Password	Role	Set
		Admin	Remove

Old Username

This field cannot be changed. “admin” is the administrator user.

Old Password

Enter the current password for the “admin” username in this field. The default password is “Atlona”.

New Password

Enter the new password for the “admin” username in this field.

Confirm New Password

Verify the new password by retyping it in this field.

Save

Click this button to commit all changes.

Configuration and Management Interfaces

System Page

The **System** page is divided into two sections: **Network** and **System**. The **Network** section allows configuration of the IP settings of the AT-OME-MH21 / AT-OME-MH21-CP. The **System** section provides controls for resetting the AT-OME-MH21 / AT-OME-MH21-CP to factory-default settings and updating the firmware.

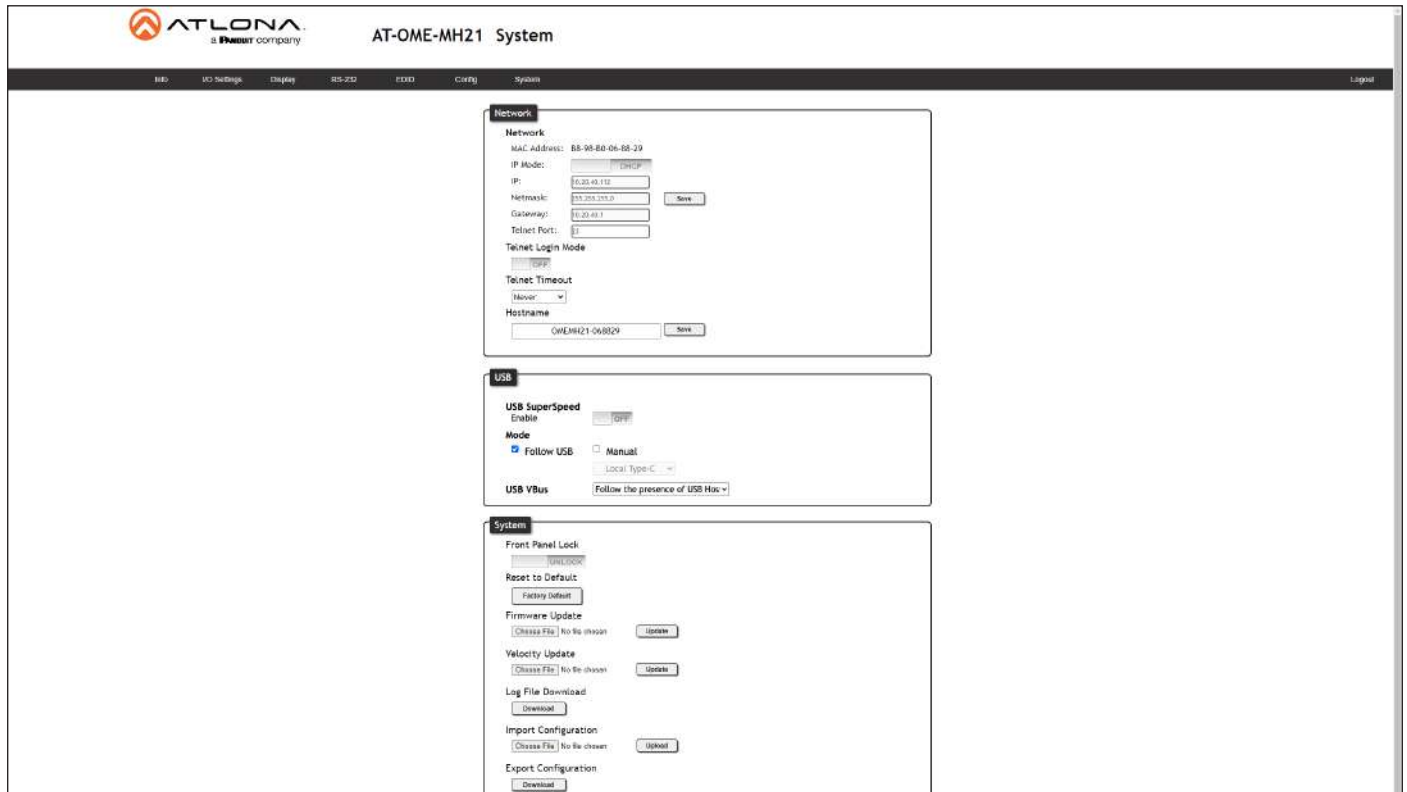

MAC Address

This field displays the MAC address of the AT-OME-MH21 / AT-OME-MH21-CP.

IP Mode

Click this toggle switch to set the AT-OME-MH21 / AT-OME-MH21-CP to **DHCP** or **STATIC IP** mode. The default setting is **DHCP** mode.

IP

Enter the IP address of the AT-OME-MH21 / AT-OME-MH21-CP in this field. This field will only be available when **IP Mode** is set to **STATIC IP**. The default static IP address of the AT-OME-MH21 / AT-OME-MH21-CP is 192.168.1.254.

Netmask

Enter the subnet mask of the AT-OME-MH21 / AT-OME-MH21-CP in this field. This field will only be available when **IP Mode** is set to **STATIC IP**.

Gateway

Enter the gateway (router) IP address in this field. This field will only be available when **IP Mode** is set to **STATIC IP**.

Telnet Port

Enter the desired Telnet port (for Telnet sessions) in this field. The default port is 23. Refer to [Changing the Telnet Port \(page 34\)](#) for more information.

Configuration and Management Interfaces

Telnet Login Mode

Click this toggle switch to set the Telnet Login Mode to **ON** or **OFF**. If set to **ON**, then login credentials (same as web server) will be required when starting a Telnet session.

Telnet Timeout

Click this drop-down list to select the timeout interval, in seconds. Range is: 10 to 3600 seconds, or Never. Refer to [Adjusting Telnet Timeout \(page 35\)](#) for more information.

Hostname

Displays the hostname of the AT-OME-MH21 / AT-OME-MH21-CP, as it would appear on a network. To change the hostname, type the new hostname in this field and click the **Save** button. Refer to [Setting the Host Name \(page 36\)](#) for more information.

USB SuperSpeed

Click the **Enable** toggle switch to the **ON** position to enable USB SS (Super Speed) mode on the USB-C input. Enabling USB SS mode provides data rates up to 5 Gbit/s (625 MB/s), allowing a maximum resolution of 4096x2048 @ 30 Hz RGB. If this feature is disabled, resolutions up to 4096x2048 @ 60 Hz are supported.

Mode

Selects the desired USB switching mode. Refer to [USB Modes \(page 42\)](#) for more information.

Setting	Description
Follow USB	If both USB host ports are connected to host devices, then the AT-OME-MH21 / AT-OME-MH21-CP will set the last-connected USB host device as the “active” USB host.
Manual	This mode provides manual selection of the USB host port to be used. When this mode is selected, select either Local Type-C or Local USB 1 from the drop-down list.

USB VBus

Adjusts the power function of the USB hub ports.

Setting	Description
Follow the presence of USB Host	Allows the USB hub ports to toggle on and off based on the presence of a USB host.
Always High	Keeps the USB power on the hub ports always on. For example, connecting the AT-CAP-SP100 to the AT-OME-MH21 / AT-OME-MH21-CP, when no host is connected, would allow the speakerphone to charge, continuously.

Front Panel Lock

Click this toggle switch to **LOCK** or **UNLOCK** the AT-OME-MH21 / AT-OME-MH21-CP. Refer to [Locking / Unlocking the Front Panel \(page 37\)](#) for more information.

Reset to Default

Click the **Factory Default** button to reset the AT-OME-MH21 / AT-OME-MH21-CP to factory-default settings. Refer to [Resetting to Factory-Default Settings \(page 38\)](#) for more information.

Firmware Update

Click the **Choose File** button to begin the firmware update procedure. Refer to [Updating the Firmware \(page 58\)](#) for more information.

Velocity Update

Click the **Choose File** button to upgrade the Velocity database in the AT-OME-MH21 / AT-OME-MH21-CP.

Configuration and Management Interfaces

Log File Download

Click the **Download** button to download the system event log file to the connected PC.

Import Configuration

Click the **Choose File** button to select a configuration file to restore. Click the **Upload** button to upload the configuration file to the AT-OME-MH21 / AT-OME-MH21-CP. Restoring a configuration file will erase the current unit configuration.

Export Configuration

Click the **Download** button to save the current system configuration to a local file.

Appendix

Updating the Firmware

Updating the firmware is performed using the built-in web server.

Using the Web Server

Requirements:

- AT-OME-MH21 / AT-OME-MH21-CP
 - Firmware file
 - Computer on the same network as the AT-OME-MH21 / AT-OME-MH21-CP
1. Download the firmware file from atlon.com and extract the contents of the .zip file to a folder on the computer desktop.
 2. Power on the unit and connect an Ethernet cable from the computer, containing the firmware, to the same network where the AT-OME-MH21 / AT-OME-MH21-CP is connected.
 3. Login to the web server. Refer to [Web Server \(page 18\)](#) for more information.
 4. Click **System** in the menu bar.

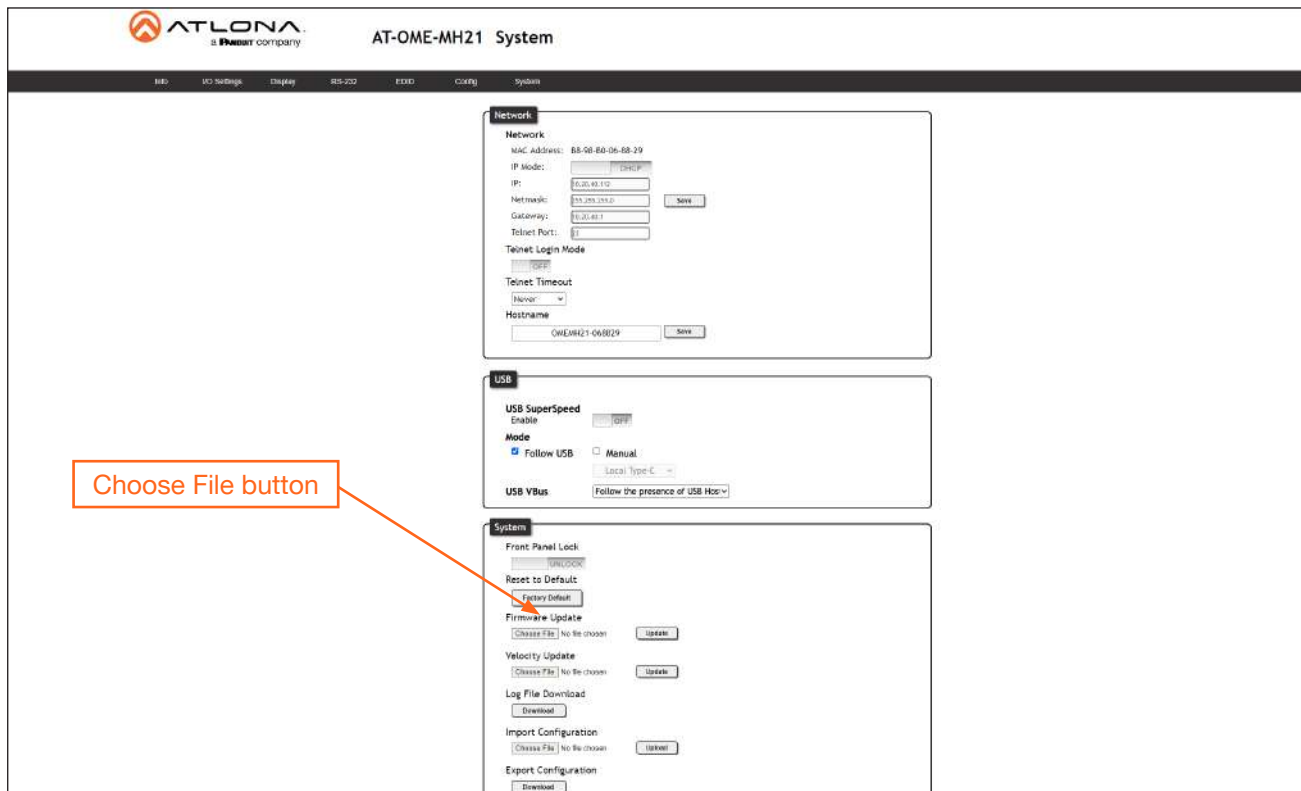

5. Click the **Choose File** button, under the **Firmware Update** section.

6. Browse to the location of the firmware file, select it, and click the **Open** button. Click the **Update** button, under the **Firmware Update** section. The following message box will be displayed.

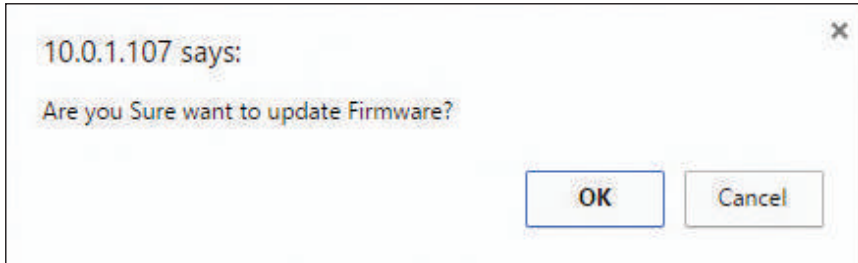

7. Click the **OK** button to begin the firmware update process. Click the **Cancel** button to cancel the process.
8. After the firmware update process is complete, the **Login** screen will be displayed.

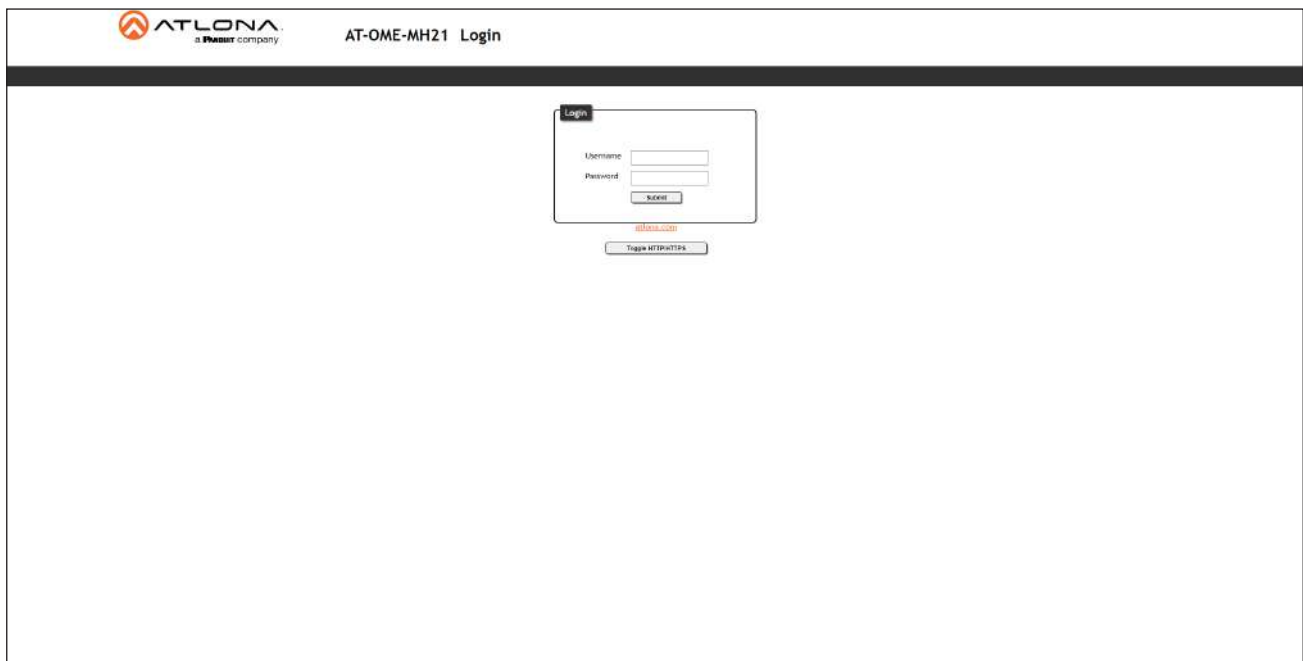

Using USB

Requirements:

- AT-OME-MH21 / AT-OME-MH21-CP
- Firmware file
- PC or Mac computer
- USB-A to USB-B cable

1. Make sure the unit is powered, using the included power supply.
2. Press and hold the **INPUT** button. While depressing the **INPUT** button, connect the USB cable between the **HOST USB** port on the AT-OME-MH21 / AT-OME-MH21-CP and the computer containing the firmware.

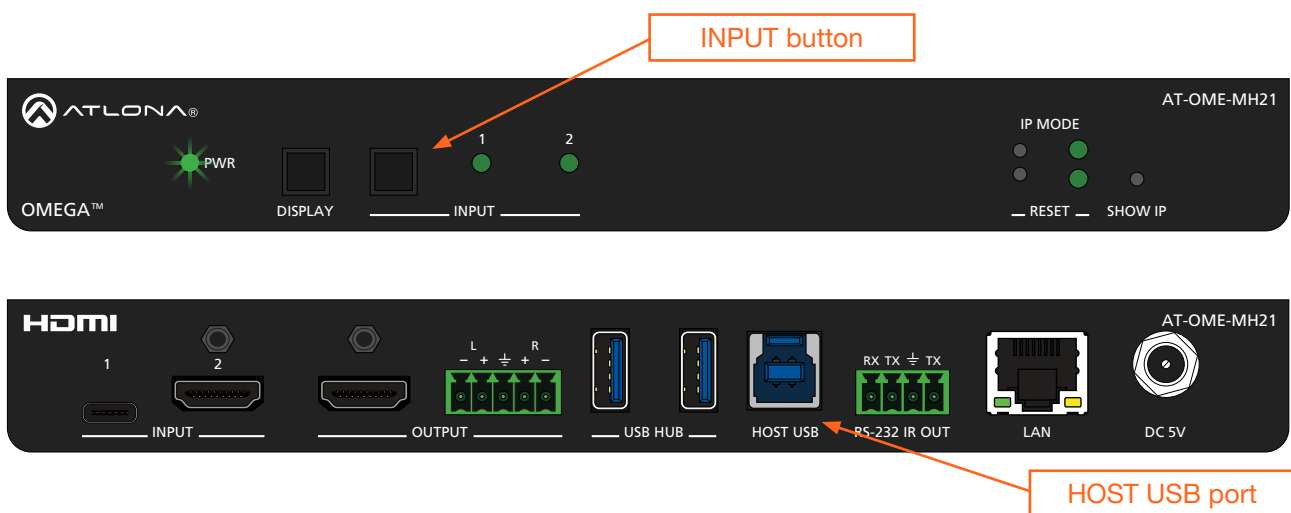

3. A virtual USB drive will be created and the folder of this drive will be displayed. If this folder is not displayed automatically, then select the drive from within Windows Explorer (Windows) or the Finder (Mac).
4. Delete all files from the drive, if any are present.
5. Drag-and-drop the firmware file to the drive folder. The **PWR** LED indicator will flash green during the update procedure.
6. Disconnect the USB cable from the AT-OME-MH21 / AT-OME-MH21-CP.
7. The AT-OME-MH21 / AT-OME-MH21-CP will automatically reboot. When the **PWR** LED indicator is solid green, the firmware update process will be complete. The unit is now ready for use.

Integration with the AT-OCS-900N



NOTE: Both the AT-OME-MH21 and AT-OME-MH21-CP support a maximum of three AT-OCS-900N devices.

The following provides instructions on adding the AT-OCS-900N occupancy sensor as a device. The **Auto Switch** feature on the AT-OME-MH21 / AT-OME-MH21-CP does not need to be enabled for this to work.



IMPORTANT: A username and password must be configured on the AT-OCS-900N before using the device with the AT-OME-MH21 / AT-OME-MH21-CP.

1. Connect the AT-OCS-900N to the same network as the AT-OME-MH21 / AT-OME-MH21-CP. Refer to the AT-OCS-900N User Manual for more information.
2. Login to the web server of the AT-OME-MH21 / AT-OME-MH21-CP.
3. Click **Display** in the top menu bar.
4. Under the **Occupancy Sensor Control** section, enter the IP address of the AT-OCS-900N in the **IP Address** field.

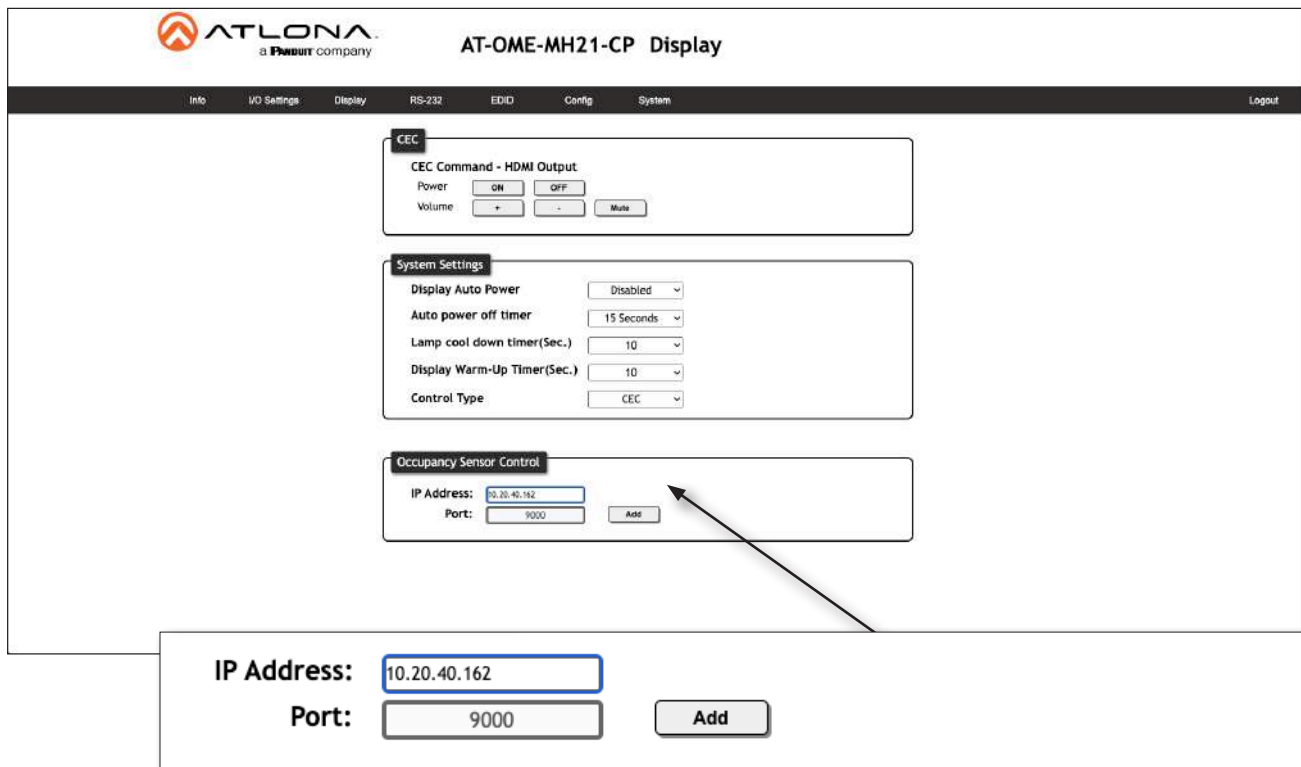

The screenshot shows the AT-OME-MH21-CP web interface. The top navigation bar includes 'Info', 'IO Settings', 'Display', 'RS-232', 'EDID', 'Config', 'System', and 'Logout'. The main content area is divided into three sections: 'CEC' (with Power ON/OFF and Volume +/- Mute buttons), 'System Settings' (with dropdowns for Display Auto Power, Auto power off timer, Lamp cool down timer, Display Warm-Up Timer, and Control Type), and 'Occupancy Sensor Control'. In the 'Occupancy Sensor Control' section, the 'IP Address' field is highlighted with a blue border and contains the value '10.20.40.162'. Below it, the 'Port' field contains '9000' and there is an 'Add' button. An arrow points from the 'IP Address' field in the screenshot to a larger, detailed view of the 'IP Address' and 'Port' fields at the bottom of the screenshot, which shows the 'IP Address' field with '10.20.40.162', the 'Port' field with '9000', and an 'Add' button.

5. Click the **Add** button. If the correct IP address was entered and the AT-OCS-900N is found, additional information will be displayed under the Occupancy Sensor Control section, as shown on the next page.

IP Address:	<input type="text"/>				
Port:	<input type="text" value="9000"/>	<input type="button" value="Add"/>			
10.20.40.162	<input type="button" value="Connected"/>	<input type="button" value="Vacant"/>	<input type="button" value="Identify"/>	<input type="button" value="Remove"/>	
Turn Display On on Occupancy	<input type="checkbox"/>	<input type="button" value="DISABLED"/>			
Turn Display Off on Vacancy	<input type="checkbox"/>	<input type="button" value="DISABLED"/>			

6. Click the **Turn Display On on Occupancy** toggle to enable or disable this feature. When enabled, the toggle switch will display as **ENABLED** and the occupancy sensor will power-on the display when the room is occupied.
7. Click the **Turn Display Off on Vacancy** toggle to enable or disable this feature. When enabled, the toggle will display as **ENABLED** and the occupancy sensor will power-off the display when the room is no longer occupied.
8. Click the **Identify** button to identify the occupancy sensor. This feature is useful when multiple sensors are connected.



IMPORTANT: When adding an occupancy sensor, it is recommended that a static IP address is assigned to the occupancy sensor. DHCP is not recommended.

9. Click the **Remove** button to delete a sensor from the **Sensors** list.
10. Setup is complete.

Mounting Instructions

The AT-OME-MH21 / AT-OME-MH21-CP includes two mounting brackets, which can be used to attach the unit to any flat surface. Use the two enclosure screws, on the sides of the unit to attach the mounting brackets.



IMPORTANT: When mounting the AT-OME-MH21 / AT-OME-MH21-CP, ensure the mounting height does not exceed 2 meters (6.56 feet).

1. Using a small Phillips screwdriver, remove the two screws from the left side of the enclosure.



2. Position one of the mounting brackets, as shown below, aligning the holes on the side of the enclosure with one set of holes on the mounting bracket.
3. Use the screws from Step 1 to attach the mounting bracket.



- Repeat steps 1 and 2 to attach the second mounting bracket to the opposite side of the unit.
- Mount the unit to a flat surface using the oval-shaped holes, on each mounting bracket. If using a drywall surface, a #6 drywall screw is recommended.



NOTE: Mounting brackets can also be inverted to mount the unit under a table or other flat surface.

Specifications

AT-OME-MH21

Video		
Signal	Input - HDMI, USB-C Output - HDMI	
Copy Protection	HDCP 2.2	
Pixel Clock	600 MHz	
UHD/HD/SD	4096x2160@60/50/30/25/24 Hz 3840x2160@60/50/30/25/24 Hz 1920x1080p@60/59.9/50/30/ 29.97/25/24/23.98 Hz 1920x1080i@30/29.97/25 Hz 1280x720p@60/59.94/50 Hz	720x576p@50 Hz 720x576i@50 Hz 640x480p@60/59.96 Hz 640x480i@30 Hz
VESA All resolutions are 60Hz	2560x1600 2048x1536 1920x1200 1680x1050 1600x1200 1440x900 1400x1050 1280x1024	1280x800 1366x768 1360x768 1152x864 1024x768 800x600 640x480
VESA 21:9	5120x2160 @ 30 Hz 4:4:4 3840x1600 @ 60 Hz 4:4:4 3840x1600 @ 30 Hz 4:4:4 3440x1440 @ 60 Hz 4:4:4	3440x1440 @ 50 Hz 4:4:4 3440x1440 @ 30 Hz 4:4:4 2560x1080 @ 60 Hz 4:4:4 2560x1080 @ 30 Hz 4:4:4
Scaler ⁽¹⁾	IN	OUT
	4K@24 Hz 4K@30 Hz 4K@60 Hz	1080p@24 Hz 1080p@30 Hz 1080p@60 Hz
Color Space	YUV, RGB	
Chroma Subsampling	4:4:4, 4:2:2, 4:2:0 ⁽²⁾	
Color Depth	8-bit, 10-bit, 12-bit	
HDR	HDR10, Hybrid-Log Gamma (HLG), and Dolby® Vision™ @ 60 Hz	

Audio			
HDMI Pass-Through Formats	PCM 2.0 LPCM 5.1 LPCM 7.1	Dolby® Digital Dolby Digital Plus™ Dolby TrueHD	DTS® Digital Surround™ DTS-HD Master Audio™
Bit Rate	24 Mbits/s max		
Analog Audio			
Format	2-channel stereo		
Balanced Output	+4 dBu, nominal gain; +20 dBu headroom		
Frequency Response	20 Hz to 20 kHz, ±0.5 dB		
Impedance	150 Ω		
Stereo channel separation	> 90 dB		
THD + N	< 0.004% @ 20 Hz to 20 kHz		
SNR	> 94 dB @ 1 kHz, zero clipping @ 0 dBFS, unweighted		

USB	
Compliance	3.0
Maximum Data Rate	5 Gbps ⁽³⁾
USB-C	Supports audio, video, device and host data
Internal Hubs	1 USB hub (when connected to USB-C or USB type B host port)

Ethernet	
Port	1 x RJ45
Standards and Protocols	HTTP, HTTPS, Telnet, mDNS
Speeds	10/100 Mbps
Addressing	DHCP, Static – selectable through front panel, IP, RS-232 commands, and built-in web server

RS-232	
Port	1 x 4-pin captive screw; TX, RX, GND
Use	Device control and configuration
Baud Rates	2400, 4800, 9600, 19200, 38400, 57600, 115200
Data flow	Bidirectional

IR	
Port	1 x 4-pin captive screw; TX, GND
Use	Pass-through control
Frequency Range	30 kHz to 60 kHz

CEC	
Port	1 x HDMI OUTPUT, Type A, 19-pin female
Triggering	Through IP, RS-232, and built-in web server

Resolution / Distance	4K/UHD - Feet / Meters		1080p - Feet / Meters	
HDMI IN/OUT	15	5	30	10
USB-C ⁽⁴⁾	6.6	2	6.6	2

Buttons and Indicators	
Buttons: DISPLAY, INPUT IP MODE, RESET	2 – momentary, tact-type 2 – momentary, tact-type
Indicators: PWR, INPUT IP MODE, RESET	3 – LED, green 2 – LED, green

Connectors	
HDMI IN	1 – Type A, 19-pin female
USB-C IN	1 – USB Type-C v3.1, 24-pin female, AV input (Alternate Mode)
HDMI OUT	1 – Type A, 19-pin female
USB HUB	2 – Type A, 4-pin female
USB HOST	1 – Type B, female
AUDIO OUT	1 – 5-pin captive screw, balanced / unbalanced 2-channel
RS-232 / IR OUT	1 – 4-pin captive screw (bidirectional)
LAN	1 – RJ45, 100Base-T
PWR	1 - Barrel connector, locking

Environmental	Fahrenheit	Celsius
Operating Temperature	+32 to +122	0 to +50
Storage Temperature	-4 to +140	-20 to +60
Operating Humidity (RH)	20% to 90%, non-condensing	
Maximum Operating Altitude	2000 meters	

Power		
Consumption	Max: 14.5 W	
BTU/h	49.4	
External Power Supply	100 - 240 V AC, 50/60 Hz Output: 5 V / 4 A DC	

Dimensions (H x W x D)	Inches	Millimeters
Unit	1.02 x 8.62 x 5.98	26 x 219 x 152
Power Supply (AT-PS-54-L)	1.22 x 1.97 x 3.17	31 x 50 x 80.6

Weight	Pounds	Kilograms
Device	2.15	0.975

Certification		
Device	CE, FCC, CB	
Power Supply	CE, FCC, UL, CB	

Compliance		
NDA-899	Yes	
TAA	Yes	

Warranty		
Device	3 years	

Footnotes

(1) Scaler does not support frame rate conversion.

(2) 4:2:0 is not supported over USB-C.

(3) When USB SuperSpeed (SS) mode is enabled, video output is supported up to 4K @ 30 Hz and the USB data rate is 5 Gbps. If disabled, video output is supported up to 4K @ 60 Hz and data rate is limited to 480 Mbps.

(4) The cable used for USB-C connection should support at least USB 3.1 Gen. 1, 4K @ 60 Hz video, and 60 W of power delivery.

AT-OME-MH21-CP

Video		
Signal	Input - HDMI, USB-C Output - HDMI	
Copy Protection	HDCP 2.2	
Pixel Clock	600 MHz	
UHD/HD/SD	4096x2160@60/50/30/25/24 Hz 3840x2160@60/50/30/25/24 Hz 1920x1080p@60/59.9/50/30/ 29.97/25/24/23.98 Hz 1920x1080i@30/29.97/25 Hz 1280x720p@60/59.94/50 Hz	720x576p@50 Hz 720x576i@50 Hz 640x480p@60/59.96 Hz 640x480i@30 Hz
VESA All resolutions are 60Hz	2560x1600 2048x1536 1920x1200 1680x1050 1600x1200 1440x900 1400x1050 1280x1024	1280x800 1366x768 1360x768 1152x864 1024x768 800x600 640x480
VESA 21:9	5120x2160 @ 30 Hz 4:4:4 3840x1600 @ 60 Hz 4:4:4 3840x1600 @ 30 Hz 4:4:4 3440x1440 @ 60 Hz 4:4:4	3440x1440 @ 50 Hz 4:4:4 3440x1440 @ 30 Hz 4:4:4 2560x1080 @ 60 Hz 4:4:4 2560x1080 @ 30 Hz 4:4:4
Scaler ⁽¹⁾	IN	OUT
	4K@24 Hz 4K@30 Hz 4K@60 Hz	1080p@24 Hz 1080p@30 Hz 1080p@60 Hz
Color Space	YUV, RGB	
Chroma Subsampling	4:4:4, 4:2:2, 4:2:0 ⁽²⁾	
Color Depth	8-bit, 10-bit, 12-bit	
HDR	HDR10, Hybrid-Log Gamma (HLG), and Dolby® Vision™ @ 60 Hz	

Audio			
HDMI Pass-Through Formats	PCM 2.0 LPCM 5.1 LPCM 7.1	Dolby® Digital Dolby Digital Plus™ Dolby TrueHD	DTS® Digital Surround™ DTS-HD Master Audio™
Bit Rate	24 Mbits/s max		
Analog Audio			
Format	2-channel stereo		
Balanced Output	+4 dBu, nominal gain; +20 dBu headroom		
Frequency Response	20 Hz to 20 kHz, ±0.5 dB		
Impedance	150 Ω		
Stereo channel separation	> 90 dB		
THD + N	< 0.004% @ 20 Hz to 20 kHz		
SNR	> 94 dB @ 1 kHz, zero clipping @ 0 dBFS, unweighted		

USB	
Compliance	3.0
Maximum Data Rate	5 Gbps ⁽³⁾
USB-C	Supports audio, video, device and host data, and up to 60 W power charging
Internal Hubs	1 USB hub (when connected to USB-C or USB type B host port)

Ethernet	
Port	1 x RJ45
Standards and Protocols	HTTP, HTTPS, Telnet, SSH, mDNS
Speeds	10/100 Mbps
Addressing	DHCP, Static – selectable through front panel, IP, RS-232 commands, and built-in web server

RS-232	
Port	1 x 4-pin captive screw; TX, RX, GND
Use	Device control and configuration
Baud Rates	2400, 4800, 9600, 19200, 38400, 57600, 115200
Data flow	Bidirectional

IR	
Port	1 x 4-pin captive screw; TX, GND
Use	Pass-through control
Frequency Range	30 kHz to 60 kHz

CEC	
Port	1 x HDMI OUTPUT, Type A, 19-pin female
Triggering	Through IP, RS-232, and built-in web server

Resolution / Distance	4K/UHD - Feet / Meters		1080p - Feet / Meters	
HDMI IN/OUT	15	5	30	10
USB-C ⁽⁴⁾	6.6	2	6.6	2

Buttons and Indicators	
Buttons: DISPLAY, INPUT IP MODE, RESET	2 – momentary, tact-type 2 – momentary, tact-type
Indicators: PWR, INPUT IP MODE, RESET	3 – LED, green 2 – LED, green

Connectors	
HDMI IN	1 – Type A, 19-pin female
USB-C IN	1 – USB Type-C v3.1, 24-pin female, AV input (Alternate Mode)
HDMI OUT	1 – Type A, 19-pin female
USB HUB	2 – Type A, 4-pin female
USB HOST	1 – Type B, female
AUDIO OUT	1 – 5-pin captive screw, balanced / unbalanced 2-channel
RS-232 / IR OUT	1 – 4-pin captive screw (bidirectional)
LAN	1 – RJ45, 100Base-T
PWR	1 – 4-pin mini-DIN

Environmental	Fahrenheit	Celsius
Operating Temperature	+32 to +122	0 to +50
Storage Temperature	-4 to +140	-20 to +60
Operating Humidity (RH)	20% to 90%, non-condensing	
Maximum Operating Altitude	2000 meters	

Power		
Consumption	Unit only: 6.0 W Full load: 90.4 W (while powering USB-C devices up to 60 W and USB Type A devices up to 9 W total across all ports)	
External Power Supply	100 - 240 V AC, 50/60 Hz Output: 24 V / 5 A DC	

Dimensions (H x W x D)	Inches	Millimeters
Unit	1.02 x 8.62 x 5.98	26 x 219 x 152
Power Supply (AT-PS-245-D4)	1.59 x 2.63 x 6.17	41 x 67 x 157

Weight	Pounds	Kilograms
Device	2.15	0.975

Certification		
Device	CE, FCC, CB	
Power Supply	CE, FCC, UL, CB	

Compliance		
NDAA-899	Yes	
TAA	Yes	

Warranty		
Device	3 years	

Footnotes

- (1) Scaler does not support frame rate conversion.
- (2) 4:2:0 is not supported over USB-C.
- (3) When USB SuperSpeed (SS) mode is enabled, video output is supported up to 4K @ 30 Hz and the USB data rate is 5 Gbps. If disabled, video output is supported up to 4K @ 60 Hz and data rate is limited to 480 Mbps.
- (4) The cable used for USB-C connection should support at least USB 3.1 Gen. 1, 4K @ 60 Hz video, and 60 W of power delivery.

