

## 01 INTRODUCTION



This manual is an integral part of the product and must be read and understood in all its parts for safety reasons. It contains norms and directions for correct and safe use of the screen. The manual should never be separated from the product; it must be stored in a suitable place to ensure its integrity, and in such a way as to be easily consulted by authorised personnel. Product user shall be responsible for the manual's safekeeping. User shall also be responsible for checking the screen's functionality and for the repair or replacement of any damaged parts that could pose a hazard.

Images contained in this manual are intended to provide a detailed description of the product's functions, characteristics and procedures. Any slight difference, depending on the model represented, will not change the meaning that the images convey.

## 02 GENERAL SAFETY NORMS



**CAUTION:** Important safety instructions. Follow the instructions as improper installation can cause serious injury. Always read the instructions and warnings set out in this manual very carefully before using the product or before performing any maintenance interventions.

- Installation of the screen above passageway is strictly forbidden. Before and during use, check that the screen poses no risk of hazard.

- Do not tamper with, remove or damage any part or component of the screen.

- Never carry out maintenance work on the screen with the motor on and always disconnect the power first.

- Always disconnect the power when cleaning, carrying out maintenance or replacing parts.

- Not children safe. It is mandatory to keep children away during operations with the screen.

All our screens are covered by guarantee; validity of the same shall be subject to user's full compliance with the instructions contained in this manual.

**WARNING:** Faulty installation may compromise the safety of the product's operators; manufacturer shall not be held liable for damages to persons or things resulting from faulty installation, improper use, insufficient or inadequate maintenance of the screen.

Manufacturer shall not be held responsible for problems associated with installation errors.

Screen installation, electrical connections and verifications in case of malfunction of motorised rolling screens must be performed by authorised vendor or by personnel that is informed and trained in electrical hazards. The connection cable cannot be replaced. If the cable is damaged the screen must be replaced. Tampering with end stops or piercing the seal placed over holes shall entail the forfeiture of the guarantee. For any necessary clarifications please contact our technical office.

N.B. ONCE THE SCREEN HAS BEEN MOUNTED ON THE BRACKETS, AND PRIOR TO USING IT, USER IS MANDATORILY REQUIRED TO ENSURE THAT THE SCREEN'S POSITION IS PERFECTLY HORIZONTAL.



## 03 WARNINGS AND RECOMMENDATIONS FOR CORRECT USE AND INSTALLATION

Our screens are suitable for indoor use at normal temperature (20 - 25 °C) and humidity conditions.

It is strongly not recommended to install the video projection screens in front of windows or use them near strong sources of light, near heat sources, such as stoves, fireplaces or flues near air conditioning systems, for both cold or warm air. Failing to comply with these recommendations may cause deformation or permanent stretching of the projection fabric.

Special precautions are required when using the motorised screen outdoors, including:

- 1- Use of appropriate ducts or sheaths suitable for outdoor installation to protect the motor power cable(s) from UV radiation.
- 2- Use of cable glands to seal against water and moisture at joints with switch/socket or junction boxes.
- 3- Use of switches with a protection level of IP55 or higher (the switch supplied with the product is not suitable for outdoor use).
- 4- Cover and protect the screen from direct contact with water or liquids.

Since electrostatic charge tends to accumulate on the projection screen (which is made of PVC), attracting dust, excessive dustiness in the projection environment can deteriorate the optical quality of the screen (see projection screen cleaning instructions).

To avoid yellowing, screens must not be exposed to sunlight. Screens must never be mounted near sources of heat or exposed to sunlight, as this could damage projection surface.

When using a motorized roller projector screen, the fabric must be fully extended before use and fully retracted after use. Please try to allow a reasonable amount of time between extending and retracting the screen, as multiple, consecutive uses could be harmful to the screen. The screen motor has a built in thermal cut-off to prevent the screen from overheating in such situations, which would normally be between 3 and 6 consecutive uses of extended and retracted. We would strongly recommend you do not put the motor under such stress, as the excess heat in the housing can cause deformation and stretching of the fabric itself. If you do find yourself in a situation where you have used the screen 3 times of extended and retracted continuous or in a short space of time, we recommend that you wait up to 40 minutes for the motor to cool down before using it again.

**WARNING:** Do not manually force the screen's unrolling: this could result in the motor being damaged or the screen's case to come away from the wall mount brackets.

Do not allow children to play with the screen's control panel. Keep remote control out of children's reach.

Monitor screen movement and allow no-one near it until it is completely closed.

The following operations: blocking, preventing or forcing the screen's movement, hanging or swinging from it, adding or applying any object to the screen or backdrop, modifying the screen's structure – are strictly forbidden and could result in damages to the screen's rolling system and ensuing hazard to persons and things.

Absolutely forbidden to install the video projection screens in front of windows.

Absolutely forbidden to install the video projection screens near heat sources, such as stoves, fireplaces or flues near air conditioning systems, for both cold or warm air.

Place the screens perfectly horizontal.



## PRODUCT'S DISPOSAL



As is the case for installation procedures, when the product reaches the end of its useful life, disposal operations must be carried out by qualified personnel.

The product is made up of various types of material: some can be recycled, others have to be disposed of. You must follow applicable recycling or disposal regulations in force in your area for this product category.

As shown in the picture on the left, you must not throw the product into a domestic litter bin. Either dispose of the various components separately, pursuant to the regulations applicable in your territory, or hand the product over to a vendor upon purchasing a similar new product.

Warning: local regulations can foresee heavy fines in case of unlawful disposal of this product.

## 04 GENERAL CHARACTERISTICS OF THE PRODUCT

The screen product is manufactured in compliance with the provisions of the following EC directives: 2014-35-CE LDV Low voltage  
 2014-30-EU EMC Electromagnetic compatibility  
 2014-53-CE Radio Equipment  
 2009-125-CE CONSUMPTION Ecodesign  
 2015-863-EC ROHS Restriction of Hazardous Substances  
 2012-19-CE RAEE Waste management  
 2001-95-CE SAFETY Safe Product

The screen described in this manual must be used exclusively as a support for video projection. Any other use not covered by this manual, it is not consented.

The screen contains one or more Fabric/sheet of projection. The Fabric of projection is a cadmium-free plastic pvc sheet or Glass wire (continuous filament) plastified PVC impregnated, any fabric can be classified in category:

- M1 and M2 fire classification under French standards (LNE Laboratoire national de métrologie et d'essais – French Companies CREPIM – Efectis France);
- B1 and B2 fire classification under German standards (Exova Warringtonfire Laboratory of Frankfurt am Main);
- Bs1d0 fire classification under Italian standards (Italian Interior Ministry).

In the absence of a standardisation at a European level of the various national classification norms, it should be noted that the French M1 class corresponds to non flammable material and that M2 class corresponds to flame retardant material. The screens use projection fabrics/sheets composed mainly of plasticized PVC or fibreglass. As these fabrics are sensitive to temperature and humidity, the acceptable size tolerance is 1% in each dimension.

There is a tolerance of +/-2 mm on the aluminium profiles used.

The tolerance on the overall size are:

- +/- 3 mm up to an overall size of 2500 mm;
- +/- 5 mm up to an overall size of 4000 mm;
- +/- 10 mm up to an overall size of 8000 mm;
- +/- 20 mm up to an overall size of 16000 mm;
- +/- 30 mm up to an overall size of 24000 mm.

## 05 CLEANING AND MAINTENANCE

Screens and their projection surfaces are delicate and must be cleaned with great care, according to the following instructions:

Never use solvents, chemical or abrasive products, or pointed tools to clean the surface.

Avoid contact with other materials (varnishes, inks etc) as they might be impossible to remove from the canvas.

**FABRIC VISION, REFERENCE, HELIOS:** Remove dust from the case with a soft, clean cloth and a non aggressive detergent as necessary.

Clean the projection screen with a soft, clean, damp cloth, and a neutral or alcohol-base detergent as necessary. Since rubbing the screen with a cloth during cleaning operations can cause electrostatic charge to accumulate, we recommend the subsequent application of an antistatic liquid with a clean cloth, to avoid dust being attracted again

**GENERIC PROFILE:** Remove dust from the case with a soft, clean cloth and a non aggressive detergent as necessary

**VELVET PROFILE:** Clean profile with a soft clean cloth, or a brush with soft, antistatic bristles. A vacuum-cleaner brush may be used, provided its bristles are soft and perfectly clean.

**STRUCTURE and ANCHORING BRACKETS:** The state of the product and the anchoring capacity of its brackets must be checked regularly. In case of canvas deformation or rips, or loosening of structural components such as brackets or screws, action must be taken immediately to clear the area around the screen and avoid hazard to people and things, replace the defective component and restore the product's functionality.

## 06 UNPACKING AND HANDING THE SCREEN

Ensure that the screen has suffered no damage during transport. Should any fault be detected, promptly notify your dealer. Verify that all screen accessories have been included

### Motorised or integrated radio roller screen

- 1 Kit with 2 installation brackets (for screens up to 2.5 m wide)
  - 1 Kit with 3 installation brackets (for screen over 2.5 m wide)
  - 1 10° unipolar, 250V dead man's selector switch with directional arrows, inclusive of wall mount hood
  - 1 RF transmitter (for integrated radio screen models)
  - 1 plastic hex wrench
  - 1 instructions booklet
- (screws and plugs for wall mount are not included)

**CAUTION** do not use cutters or sharp objects to open the wrapping, always use protection gloves when unpacking, handling and installing the product. Depending on the product's weight (reference load: 25 Kg male – 15 Kg female), handling and installing operations should be performed by two, three or four people at least. For heavier loads we recommend the use of specific lifting equipment.

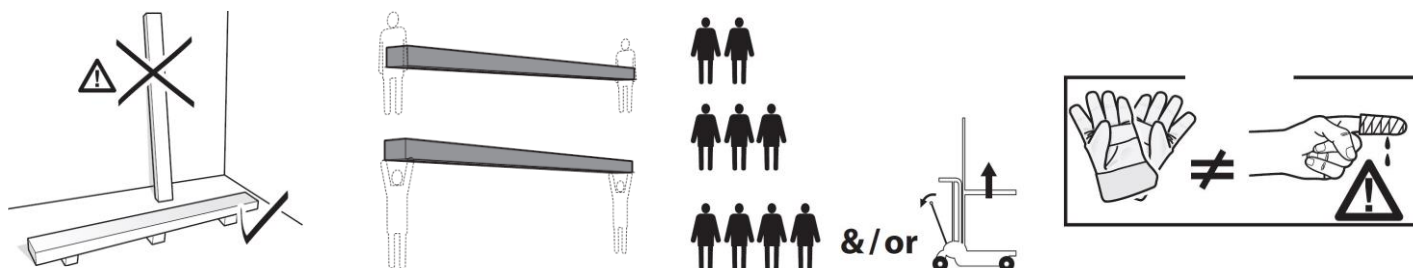

## 07 INSTALLATION INSTRUCTIONS



**WARNING:** It 's absolutely forbidden to install the screen on mobile walls or unstable cables, the brackets must be applied on surfaces that ensure in the time your distance. When installing the screen use plugs and screws suitable for the screen's weight and for the type of wall or ceiling on which the mount brackets are to be fixed, based on the following criteria

|                       |       |       |       |       |       |
|-----------------------|-------|-------|-------|-------|-------|
| Screen width up to cm | 210   | 260   | 310   | 360   | 410   |
| Overall weight        | Kg 22 | Kg 26 | Kg 33 | Kg 36 | Kg 41 |

### CEILING AND WALL INSTALLATION:

Install the screen like the image below.

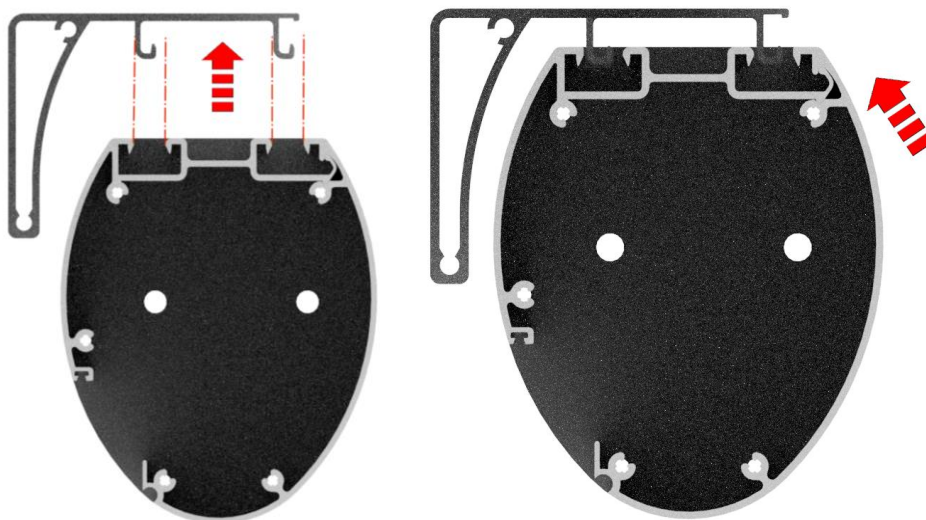
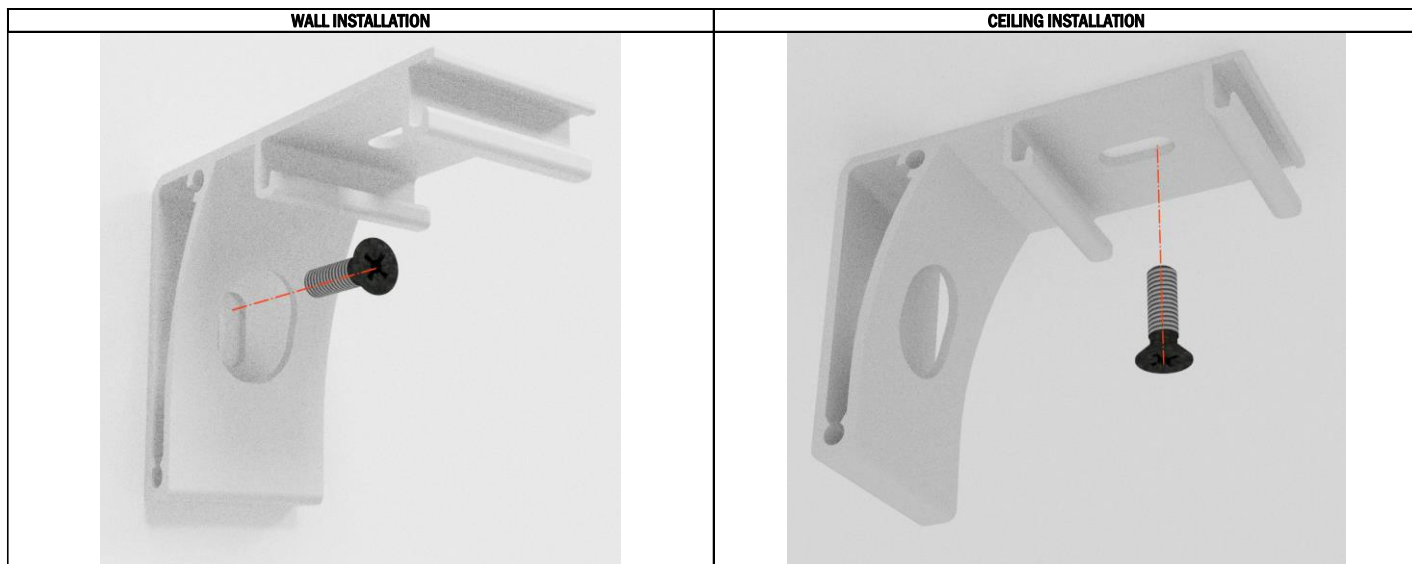

MAX DISTANCE 100mm

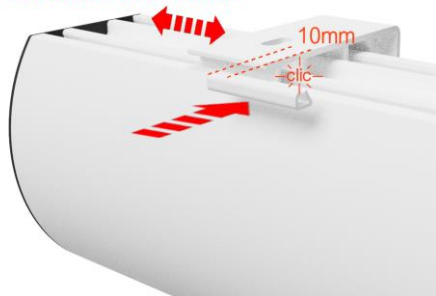

## 09 MOTOR TYPE IDENTIFICATION – CHARACTERISTICS – ELECTRICAL CONNECTION

The type of motor installed on the product is identified by a label applied on each product showing the CE logo. When unwrapping the product please check the model type indicated on the label in order to perform the installation and cable connections correctly. Should the power of the motor be different from that of the supply network of the installation place, please contact an electrician to have a current and Hz transformer installed.



### ELECTRICAL CONNECTION:

electric cabling must be conformant with applicable IEC standards. IEC norm EN 60335-1 requires that supply network be fitted with an omnipolar selector switch with contact opening distance of at least 3 mm. For the screen's control use only the selector switch provided by manufacturer, or equivalent model, and follow the instructions of the connection diagram shown on left (if the motor is mounted on the left, the colours of the wires must be inverted, i.e. descending = brown, ascending = black). The selector switch must be mounted within sight distance of the product, at a 1.5 - 1.8 m height from the floor. To connect the wires to the supplied switch, remove the plastic front plates to access the lock/unlock buttons.

### WARNING:

Correctly performed, state-of-the-art, norm-compliant electrical connections are important to prevent accidents and to ensure the screen's optimal and unaltered performance over time. Prior to carrying out any operation on electrical parts ensure that power supply is disconnected. In screens fitted with cases the motor is positioned on the right-hand side of the screen as seen from the front (upon request it can be located on the left). Never connect two or more motors to the same selector switch without a control unit or two switches to the same motor.

### SOMFY 230V 50Hz

#### Motor characteristics:

Frequency: ~Hz50  
 Power: 90W  
 Torque: 8Nm  
 Speed: 12Rpm  
 Duty cycle: S2 4min  
 Cable length: 3m  
 Mechanical strength: EN14202 conformant  
 Operating T°: from -20 to +55 °C  
 Weighted sound pressure level: LpA ≤ 70 dB(A)  
 Motor protection class: IP44

#### Connection for each motor:

- 1 Brown (Up)
- 2 Black (Down)
- 3 Blue (Common)
- 4 Yellow Green (Ground 230V)

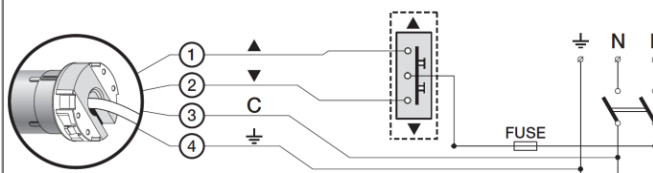

### ELECTRICAL CONNECTION:

electric cabling must be conformant with applicable IEC standards. IEC norm EN 60335-1 requires that supply network be fitted with an omnipolar selector switch with contact opening distance of at least 3 mm. For each motor (e.g. plug switch etc.). In case of need, this device ensures that the power supply is safely and quickly cut off. Use the wires as described in the figure.

### WARNING:

Correctly performed, state-of-the-art, norm-compliant electrical connections are important to prevent accidents and to ensure the screen's optimal and unaltered performance over time. Prior to carrying out any operation on electrical parts ensure that power supply is disconnected. In screens fitted with cases the motor is positioned on the right-hand side of the screen as seen from the front (upon request it can be located on the left).

Operates with standard radio control (supplied).

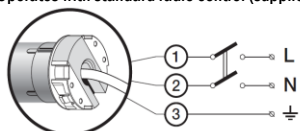

### Somfy RTS 230V 50Hz

#### Technical characteristics:

Frequency: ~ Hz50  
 Power: 120W  
 Torque: 10Nm  
 Speed: 17Rpm  
 Duty cycle: S2 4min  
 Cable length: 3m  
 Operating T°: from -20 to +55 °C  
 Frequency: 433.92 MHz  
 Trans. range: 150m  
 Weighted sound pressure level: LpA ≤ 70 dB(A)  
 Motor protection class: IP44

#### Connection for each motor:

- 1 Brown (Phase 230V)
- 2 Blue (Neutral 230V)
- 3 Yellow Green (Ground 230V)



### ELECTRICAL CONNECTION:

electric cabling must be conformant with applicable IEC standards. IEC norm EN 60335-1 requires that supply network be fitted with an omnipolar selector switch with contact opening distance of at least 3 mm. For each motor (e.g. plug switch etc.). If you want to use a switch (not supplied) follow the instructions of the connection diagram shown below (if the motor is mounted on the left, the colours of the wires must be inverted, i.e. descending = brown, ascending = black). The selector switch must be mounted within sight distance of the product, at a 1.5 - 1.8 m height from the floor.

### WARNING:

Correctly performed, state-of-the-art, norm-compliant electrical connections are important to prevent accidents and to ensure the screen's optimal and unaltered performance over time. Prior to carrying out any operation on electrical parts ensure that power supply is disconnected. In screens fitted with cases the motor is positioned on the right-hand side of the screen as seen from the front.

Operates with standard radio control (supplied).

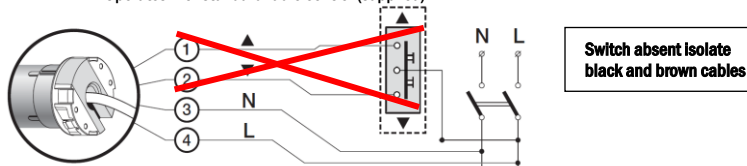

### Somfy IO 230V 50Hz

#### Technical characteristics:

Frequency: ~ Hz50  
 Power: 40W  
 Torque: 6Nm  
 Speed: 17Rpm  
 Duty cycle: S2 4min  
 Cable length: 2.5m  
 Mechanical strength: EN14202 conformant  
 Operating T°: from -20 to +55 °C  
 Frequency: 868-870 MHz  
 Weighted sound pressure level: LpA ≤ 70 dB(A)  
 Motor protection class: IP44

#### Connection for each motor:

- 1 Brown (Up)
- 2 Black (Down)
- 3 Blue (Neutro 230V)
- 4 Grey (Phase 230V)

## 10 END STOP MOTOR CHANGE (procedures already carried out in factory)



### WARNING - READ CAREFULLY BEFORE PERFORMING ADJUSTMENTS

Adjustments shown in the following table must be performed by authorised and specialised personnel only. Incorrect performance of the procedures described may result in damages to the product which will not be covered by guarantee. End stops adjustment varies depending on the motor's position (left side A column - right side B column) or on drop of the curtain (rear line C - front line D).

END STOPS ADJUSTMENT BUTTONS ARE POSITIONED IN THE LATERAL PART OF THE SCREEN, TO ACCESS IT'S NECESSARY TO REMOVE THE HEAD.

### WARNING

End stop is adjusted so as to allow the projection sheet to wind around the roller at least 1.5 times to avoid the sheet coming loose. Special attention must be paid when end stops are adjusted in such a way that projection sheet unwinds beyond the factory setting. This is allowed within a limit of 3 cm without posing a risk to the product. Incorrect adjustment of end stops can cause:

- Projection sheet coming away from the roller
- Projection sheet winding the wrong way, with ensuing damage to flatness of the projection surface and to winding mechanisms
- Breaking of bottom end black frame welding (framed screens)
- Excessive strain on motor with possible ensuing damage and activation of motor's thermal resistance
- Excessive winding of the end stop adjustment system with ensuing breaking of the mechanical part

### WARRANTY

Operators are reminded that in cases where seals have been tampered with and where any damages have resulted from incorrect adjustment, repair interventions shall not be covered by guarantee.

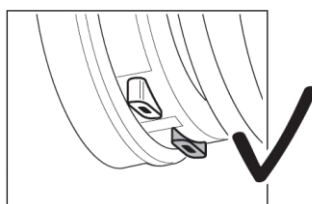
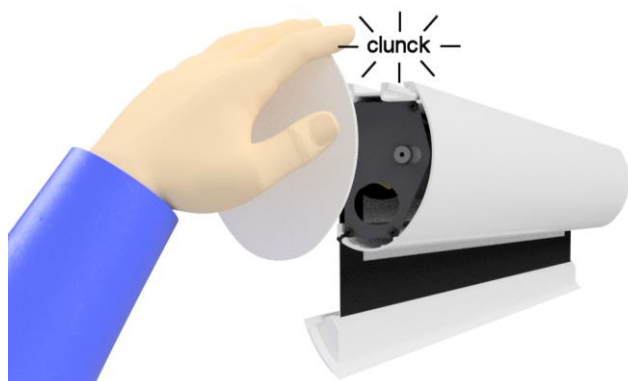

Pushed buttons = unlocked screen  
No more stop position memorized

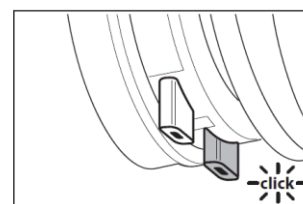

Released buttons = locked screen  
Stop positions are memorized



## 10 END STOP SOMFY MOTOR ADJUSTMENT SOMFY

|                          | A - Left Motor  | B - Right Motor (standard)  |
|--------------------------|---|---|
| Back fall (Standard) - C | <p>PRESS WHITE BUTTON</p> <p>NON TOCCARE PULSANTE GIALLO<br/>DON'T TOUCH YELLOW BUTTON<br/>NE TOUCHEZ PAS LE BOUTON JAUNE<br/>BERÜHREN SIE NICHT DIE GELBE TASTE<br/>NO TOQUE EL BOTÓN AMARILLO<br/>NIE DOTYKAĆ ŻÓŁTEGO PRZYCISKU</p> | <p>PRESS YELLOW BUTTON</p> <p>NON TOCCARE PULSANTE BIANCO<br/>DON'T TOUCH WHITE BUTTON<br/>NE TOUCHEZ PAS LE BOUTON BLANC<br/>BERÜHREN SIE NICHT DIE WEISSE TASTE<br/>NO TOQUE EL BOTÓN BLANCO<br/>NIE DOTYKAĆ BIAŁY PRZYCISKU</p>    |
| Frontal fall - D         | <p>PRESS YELLOW BUTTON</p> <p>NON TOCCARE PULSANTE BIANCO<br/>DON'T TOUCH WHITE BUTTON<br/>NE TOUCHEZ PAS LE BOUTON BLANC<br/>BERÜHREN SIE NICHT DIE WEISSE TASTE<br/>NO TOQUE EL BOTÓN BLANCO<br/>NIE DOTYKAĆ BIAŁY PRZYCISKU</p>    | <p>PRESS WHITE BUTTON</p> <p>NON TOCCARE PULSANTE GIALLO<br/>DON'T TOUCH YELLOW BUTTON<br/>NE TOUCHEZ PAS LE BOUTON JAUNE<br/>BERÜHREN SIE NICHT DIE GELBE TASTE<br/>NO TOQUE EL BOTÓN AMARILLO<br/>NIE DOTYKAĆ ŻÓŁTEGO PRZYCISKU</p> |

### PROGRAMMING END STOPS MOTOR SOMFY RTS 230V 50Hz/120V 60Hz (procedures already carried out in factory, SHOULD NOT be performed by unauthorised personnel)

#### Down limit switch

|  |  |   |   |   |
|--|--|---|---|---|
|  | <p>1 Move the screen surface to down limit switch.</p> | <p>2 Press both  and  at the same time until you will see a brief up and down motion of screen surface.</p> | <p>3 Move the screen with buttons  and  to reach the desired down limit position.</p> | <p>4 Press  button until you will see a brief up and down motion of screen surface to memorize the new position</p> |
|--|--|---|---|---|





#### Up limit switch

|  |   |   |   |   |
|--|---|---|---|---|
|  | <p>1. Move the screen surface to up limit switch.</p> | <p>2 Press both  and  at the same time until you will see a brief up and down motion of screen surface.</p> | <p>3 Move the screen with buttons  and  to reach the desired up limit position.</p> | <p>4 Press  button until you will see a brief up and down motion of screen surface to memorize the new position</p> |
|--|---|---|---|---|



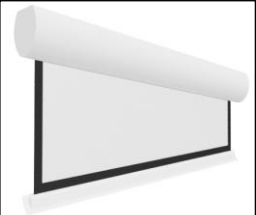

**PROGRAMMING END STOPS MOTOR SOMFY IO-homecontrol 230V 50Hz/ 120V 60Hz (procedures already carried out in factory, SHOULD NOT be performed by unauthorised personnel)**

**ATTENTION! For set up end stop limit you have to change both end stop limits up and down in one enabled procedure of adjustment**

### Down limit switch

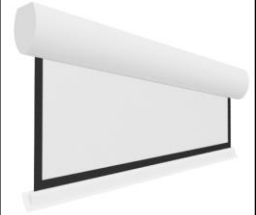
|  |   |  |  |   |
|--|---|--|--|---|
|  | <p>1. Move the screen surface to intermediate height.</p>  | <p>2. Press both <b>Λ</b> and <b>V</b> at the same time until you will see a brief up and down motion of screen surface.</p>  | <p>3. Move the screen with buttons <b>Λ</b> and <b>V</b> to reach the desired down limit position.</p>  | <p>4. Press <b>my</b> button until you will see a brief up and down motion of screen surface to memorize the new position</p>  |
|--|---|--|--|---|

### Up limit switch

|  |   |  |  |   |
|--|---|--|--|---|
|  | <p>1. Move the screen surface to intermediate height.</p>  | <p>2. Press both <b>Λ</b> and <b>V</b> at the same time until you will see a brief up and down motion of screen surface.</p>  | <p>3. Move the screen with buttons <b>Λ</b> and <b>V</b> to reach the desired up limit position.</p>  | <p>4. Press <b>my</b> button until you will see a brief up and down motion of screen surface to memorize the new position</p>  |
|--|---|--|--|---|

### GUARANTEE

**1. GUARANTEE LIMITATIONS** The Manufacturer guarantees that all the products it distributes are free of production-, material- and processing-related defects, without prejudice to the following terms and conditions:

\* The product is guaranteed for a period of twenty-four (24) months as from the date of the purchase invoice/receipt released to the end user

**2. CONDITIONS AND LIMITATIONS** This guarantee is subject to the following conditions and limitations:

the guarantee shall be deemed null and void if: the product has been used or manipulated in any manner other than those indicated in the user manual's instructions; or damaged as a result of improper use, or owing to accident or negligence during transport; or if the product's defect is the result of repair or manhandling on the part of anyone other than personnel authorized by our Customer Care office. The product must be installed by trained and experienced insider professionals, following the instructions provided for the installation and maintenance procedures.

**3. RETURNS** No product shall be returned and accepted without an authorization (RMA) released by Customer Care.

Products must be returned in their original (or equivalent) packaging to avoid being damaged during transport. Any transport damages resulting from inappropriate packaging shall not be covered by this guarantee.

The returned product shall be accompanied by a detailed description of the defect and by a photocopy of the original purchase invoice/receipt.

The purchase invoice/receipt shall clearly indicate the following: Model - Serial number - Purchase date - Name and address of the purchaser and authorized dealer.