



User's Guide

Multimedia Projector

EB-U50

EB-W50

EB-X50

Notations Used in This Guide **6**

Introduction to Your Projector **7**

Projector Features..... **8**

- Quick and Easy Setup..... 8
- Easy Wireless Projection..... 8
- Projecting for Exhibitions 9

Projector Parts and Functions **10**

- Projector Parts - Front..... 10
- Projector Parts - Rear..... 11
- Projector Parts - Base 12
- Projector Parts - Top..... 13
- Projector Parts - Remote Control 14

Setting Up the Projector **16**

Projector Placement **17**

- Projector Setup and Installation Options..... 17
- Precautions on Installation 18
- Projection Distance..... 19

Projector Connections **20**

- Connecting to a Computer..... 20
 - Connecting to a Computer for VGA Video and Audio 20
 - Connecting to a Computer for USB Video and Audio..... 21
 - Connecting to a Computer for HDMI Video and Audio 22
- Connecting to Video Sources 22
 - Connecting to an HDMI Video Source 22
 - Connecting to a Component-to-VGA Video Source 23
- Connecting to External USB Devices 24
 - USB Device Projection 24
 - Connecting to a USB Device 24

- Disconnecting a USB Device 25
- Connecting to a Document Camera 25
- Connecting to External Output Devices..... 25
 - Connecting to a VGA Monitor 25
 - Connecting to External Speakers 26

Attaching the Interface Cover..... **27**

Installing Batteries in the Remote Control **28**

Remote Control Operation **29**

Using Basic Projector Features **30**

Turning On the Projector **31**

- Home Screen 32

Turning Off the Projector **34**

Setting the Date and Time **35**

Selecting the Language for the Projector Menus **37**

Projection Modes **38**

- Changing the Projection Mode Using the Remote Control..... 38
- Changing the Projection Mode Using the Menus 38

Displaying a Test Pattern **40**

Adjusting the Image Height..... **41**

Image Shape **42**

- Auto V-Keystone 42
- Correcting the Image Shape with the Keystone Button 42
- Correcting the Image Shape with Quick Corner 43

Resizing the Image with the Zoom Ring..... **45**

Adjusting the Image Position **46**

Focusing the Image Using the Focus Ring..... **47**

Selecting an Image Source **48**

Image Aspect Ratio 49
 Changing the Image Aspect Ratio 49
 Available Image Aspect Ratios 49
 Projected Image Appearance with Each Aspect Mode 50

Adjusting Image Quality (Color Mode) 51
 Changing the Color Mode 51
 Available Color Modes..... 51
 Setting Auto Iris 51

Controlling the Volume with the Volume Buttons 53

Adjusting Projector Features 54

Projecting Two Images Simultaneously 55
 Unsupported Input Source Combinations for Split Screen Projection..... 56
 Split Screen Projection Restrictions..... 57

Projecting a PC Free Presentation..... 58
 Supported PC Free File Types..... 58
 Precautions on PC Free Projection 58
 Starting a PC Free Slide Show 59
 Starting a PC Free Movie Presentation 60
 PC Free Display Options 61

Projecting in Content Playback Mode 63
 Switching to Content Playback Mode..... 63
 Using Spotlight Mode..... 64
 Projecting Your Playlists 65
 Projecting One Image Simultaneously (Synchronized Playback) 65
 Adding Effects to Your Projected Image 66
 Content Playback Mode Restrictions 67

Shutting Off the Image and Sound Temporarily 69

Stopping Video Action Temporarily 70

Saving a User's Logo Image 71

Saving a User Pattern 72

Using Multiple Projectors..... 73
 Projector Identification System for Multiple Projector Control 73
 Setting the Projector ID..... 73
 Selecting the Projector You want to Operate 74
 Adjusting Color Uniformity..... 75
 Blending the Image Edges..... 76
 Scaling an Image 77
 Adjusting the Projector's Brightness Level 78
 Matching the Image Colors 79

Projector Security Features..... 81
 Password Security Types 81
 Setting a Password..... 81
 Selecting Password Security Types..... 82
 Entering a Password to Use the Projector 83
 Installing a Security Cable..... 83

Using the Projector on a Network 85

Wired Network Projection..... 86
 Connecting to a Wired Network..... 86
 Selecting Wired Network Settings 86

Wireless Network Projection..... 89
 Installing the Wireless LAN Module 89
 Selecting Wireless Network Settings Manually..... 90
 Selecting Wireless Network Settings in Windows 92
 Selecting Wireless Network Settings in Mac..... 92
 Setting Up Wireless Network Security..... 92
 Supported Client and CA Certificates 94
 Using a QR Code to Connect a Mobile Device..... 95
 Using a USB Key to Connect a Windows Computer 95

Secure HTTP 97
 Importing a Web Server Certificate Using the Menus..... 97

| | | | |
|---|------------|---|------------|
| Supported Web Server Certificates..... | 98 | Available Text Using the Displayed Keyboard..... | 127 |
| Monitoring and Controlling the Projector | 99 | Image Quality Settings - Image Menu | 128 |
| Epson Projector Management | 100 | Input Signal Settings - Signal Menu | 130 |
| Controlling a Networked Projector Using a Web Browser | 101 | Projector Feature Settings - Settings Menu | 131 |
| Web Control Options..... | 102 | Projector Setup Settings - Extended Menu | 133 |
| Controlling a Networked Projector in Content Playback Mode | 104 | Projector Network Settings - Network Menu | 136 |
| Web Control Options in Content Playback Mode | 105 | Network Menu - Basic Menu | 137 |
| Registering Digital Certificates from a Web Browser | 109 | Network Menu - Wireless LAN Menu | 138 |
| Setting Up Projector Network E-Mail Alerts | 110 | Network Menu - Wired LAN Menu | 140 |
| Network Projector E-mail Alert Messages | 110 | Network Menu - Notifications Menu | 141 |
| Setting Up Monitoring Using SNMP | 111 | Network Menu - Others Menu | 142 |
| Using ESC/VP21 Commands | 112 | Network Menu - Reset Menu..... | 143 |
| ESC/VP21 Command List | 112 | Projector Setup Settings - ECO Menu | 144 |
| Cable Layouts | 112 | Projector Information Display - Info Menu | 146 |
| PJLink Support | 114 | Info Menu - Projector Info Menu | 146 |
| Crestron Connected Support | 115 | Event ID Code List..... | 147 |
| Setting Up Crestron Connected Support..... | 115 | Projector Reset Options - Reset Menu | 148 |
| Controlling a Networked Projector Using Crestron Connected | 115 | Copying Menu Settings Between Projectors (Batch Setup) | 149 |
| Crestron Connected Operation Window | 117 | Transferring Settings From a USB Flash Drive | 149 |
| Crestron Connected Tools Window | 118 | Transferring Settings From a Computer | 150 |
| Art-Net Channel Definitions | 120 | Batch Setup Error Notification | 151 |
| Setting Projector Event Schedules | 122 | Maintaining the Projector | 152 |
| Adjusting the Menu Settings | 125 | Projector Maintenance | 153 |
| Using the Projector's Menus | 126 | Cleaning the Lens | 154 |
| Using the Displayed Keyboard | 127 | Cleaning the Projector Case | 155 |
| | | Air Filter and Vent Maintenance | 156 |
| | | Cleaning the Air Filter and Vents..... | 156 |
| | | Replacing the Air Filter | 158 |

Projector Lamp Maintenance 160
 Replacing the Lamp 160
 Resetting the Lamp Timer 162

Solving Problems 164

Projection Problems 165

Projector Indicator Status 166

Using the Projector Help Displays..... 169

Solving Image or Sound Problems..... 170

Solutions When No Image Appears..... 170
 Solutions When Image is Incorrect Using the USB Display Function 170
 Solutions When "No Signal" Message Appears 171
 Displaying From a Laptop..... 171
 Displaying From a Mac Laptop 171
 Solutions When "Not Supported" Message Appears 171
 Solutions When Only a Partial Image Appears..... 172
 Solutions When the Image is not Rectangular 172
 Solutions When the Image Contains Noise or Static..... 172
 Solutions When the Image is Fuzzy or Blurry 173
 Solutions When the Image Brightness or Colors are Incorrect 173
 Solutions When an Afterimage Remains on the Projected Image 174
 Solutions to Sound Problems..... 174
 Solutions When Image File Names are not Displayed Correctly in PC Free..... 175

Solving Projector or Remote Control Operation Problems..... 176

Solutions to Projector Power or Shut-Off Problems..... 176
 Solutions to Problems with the Remote Control..... 176
 Solutions to Password Problems..... 177
 Solution When "The Battery that Saves Your Clock Settings is Running Low"
 Message Appears 177

Solving Network Problems 178

Solutions When Wireless Authentication Fails 178

Solutions When You Cannot Access the Projector Through the Web 178
 Solutions When Network Alert E-Mails are not Received..... 178
 Solutions When the Image Contains Static During Network Projection 179

Solutions to Problems in Content Playback mode 180

Appendix 181

Optional Accessories and Replacement Parts..... 182

Screens 182
 Cables 182
 Mounts 182
 For Wireless Connection 182
 External Devices 183
 Replacement Parts..... 183

Screen Size and Projection Distance 184

Supported Monitor Display Resolutions 187

Projector Specifications 189

Connector Specifications 190

External Dimensions 191

USB Display System Requirements 192

List of Safety Symbols and Instructions 193

Glossary 195

Notices 197



FCC Compliance Statement..... 197
 Indication of the manufacturer and the importer in accordance with
 requirements of EU directive..... 198
 Restriction of Use 198
 Operating System References..... 198
 Trademarks..... 198
 Copyright Notice..... 199
 Copyright Attribution..... 199

Notations Used in This Guide





Safety Symbols

The projector and its manuals use graphical symbols and labels to indicate content that tells you how to use the projector safely.

Read and carefully follow the instructions that are marked with these symbols and labels to avoid injury to persons or damage to property.

| | |
|--|--|
|  Warning | This symbol indicates information that, if ignored, could possibly result in personal injury or even death. |
|  Caution | This symbol indicates information that, if ignored, could possibly result in personal injury or physical damage due to incorrect handling. |

General Information Notations

| | |
|---|---|
| Attention | This label indicates procedures that may result in damage or injury if sufficient care is not taken. |
|  | This label indicates additional information that may be useful to know. |
| [Button name] | Indicates the name of the buttons on the remote control or the projector. Example: [Esc] button |
| Menu/Setting name | Indicates projector menu and setting names. Example: Select the Image menu  Image > Advanced |
|  | This label indicates links to the related pages. |
|  | This label indicates the projector's current menu level. |

Introduction to Your Projector

Refer to these sections to learn more about your projector's features and part names.

► **Related Links**

- "Projector Features" [p.8](#)
- "Projector Parts and Functions" [p.10](#)

This projector comes with these special features. Refer to these sections for more details.

» Related Links

- "Quick and Easy Setup" [p.8](#)
- "Easy Wireless Projection" [p.8](#)
- "Projecting for Exhibitions" [p.9](#)

Quick and Easy Setup

- Direct Power On feature to turn on the projector as soon as you plug it in.
- Auto Power On feature to turn on the projector when the projector detects an image signal from the port you specified as the **Auto Power On** source.
- Home screen feature to easily select an input source and useful functions.
- Automatic vertical keystone correction always displays a rectangular screen (Auto V-Keystone).

» Related Links

- "Auto V-Keystone" [p.42](#)
- "Projector Setup Settings - Extended Menu" [p.133](#)
- "Turning On the Projector" [p.31](#)

Easy Wireless Projection

- Epson iProjection (Windows/Mac) to project up to four images at the same time by splitting the projected screen. You can project images from computers on the network, or from smartphones or tablet devices.

See the *Epson iProjection Operation Guide (Windows/Mac)* for details.

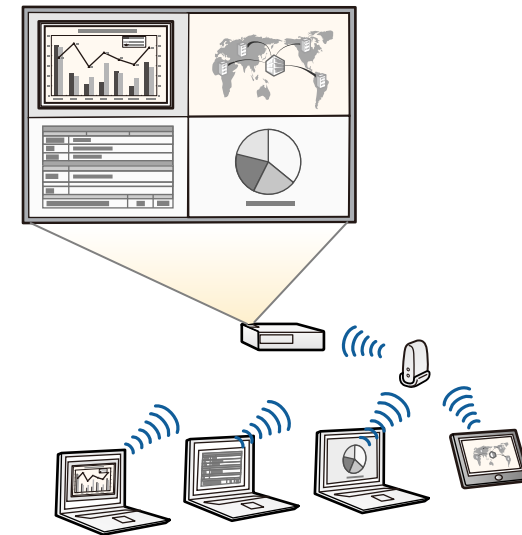

- You can download the necessary software and manuals from the following Web site:
<http://www.epson.com/>

- Epson iProjection (iOS/Android) to connect your projector and mobile device wirelessly using the app available on the App Store or Google Play.



Any fees incurred when communicating with the App Store or Google Play are the responsibility of the customer.

- Epson iProjection (Chromebook) to connect your projector and Chromebook device wirelessly using the app available on the Chrome Web Store.



Any fees incurred when communicating with the Chrome Web Store are the responsibility of the customer.

» Related Links

- "Using the Projector on a Network" [p.85](#)

Projecting for Exhibitions

- Content Playback mode to play your playlists, and add color and shape effects to your projected image.
- Epson Projector Content Manager to prepare your playlists.
See the *Epson Projector Content Manager Operation Guide* for details.



You can download the necessary software and manuals from the following Web site:

<http://www.epson.com/>



» Related Links

- "Projecting in Content Playback Mode" [p.63](#)

The following sections explain the projector parts and their functions.

» **Related Links**

- "Projector Parts - Front" [p.10](#)
- "Projector Parts - Rear" [p.11](#)
- "Projector Parts - Base" [p.12](#)
- "Projector Parts - Top" [p.13](#)
- "Projector Parts - Remote Control" [p.14](#)

Projector Parts - Front

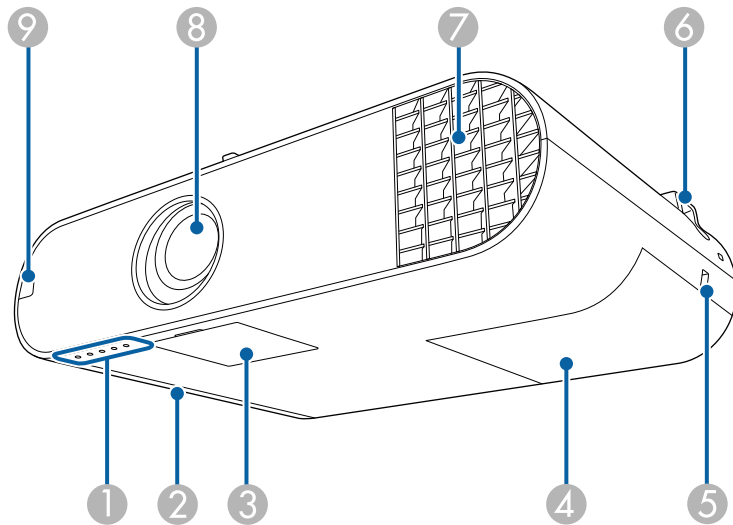

| Name | Function |
|----------------------|---|
| ① Indicators | Indicates the projector's status. |
| ② Air filter cover | Open to access the air filter. |
| ③ Power button cover | Open to access the power button, zoom ring, and focus ring. |
| ④ Lamp cover | Open to access the projector's lamp. |

| Name | Function |
|-----------------------------------|---|
| ⑤ Security slot | The security slot is compatible with the Microsaver Security System manufactured by Kensington. |
| ⑥ Security cable attachment point | Pass a commercially available wire lock through here and lock it in place. You can also attach the optional safety wire here to prevent the projector from falling from the ceiling or wall. |
| ⑦ Air exhaust vent | Exhaust vent for air used to cool the projector internally. <div style="border: 1px solid black; padding: 5px; margin: 5px 0;"> <p>⚠ Warning</p> <p>Do not look into the vents. If the lamp explodes, gases may escape and small fragments of glass may be scattered which could cause an injury. Contact a doctor if any fragments of broken glass are inhaled or get into the eyes or mouth.</p> </div> <div style="border: 1px solid black; padding: 5px; margin: 5px 0;"> <p>⚠ Caution</p> <p>While projecting, do not put your face or hands near the air exhaust vent, and do not place objects that may become warped or damaged by heat near the vent. Hot air from the air exhaust vent could cause burns, warping, or accidents to occur.</p> </div> |
| ⑧ Lens | Images are projected from here. |
| ⑨ Remote receiver | Receives signals from the remote control. |

» **Related Links**

- "Projector Indicator Status" [p.166](#)
- "Installing a Security Cable" [p.83](#)

Projector Parts - Rear

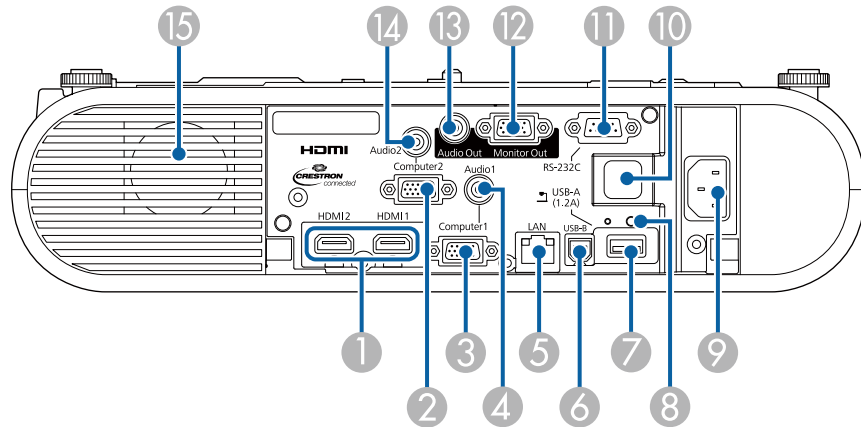

| Name | Function |
|----------------------|--|
| ① HDMI1, HDMI2 ports | Inputs video signals from HDMI compatible video equipment and computers. This projector is compatible with HDCP. |
| ② Computer2 port | Inputs image signals from a computer and component video signals from other video sources. |
| ③ Computer1 port | Inputs image signals from a computer and component video signals from other video sources. |
| ④ Audio 1 port | Inputs audio from equipment connected to the Computer1 port. |
| ⑤ LAN port | Connects a LAN cable to connect to a network. |
| ⑥ USB-B port | Connects a USB cable to the computer to project computer images. |
| ⑦ USB-A port | Connects a USB memory device or a digital camera and projects movies or images using PC Free. Connects the optional document camera. Connects the wireless LAN module (EB-W50/EB-X50). |

| Name | Function |
|--|---|
| ⑧ Wireless LAN module fixing screw (EB-W50/EB-X50) | Secures the wireless LAN module cover. |
| ⑨ Power inlet | Connects the power cord to the projector. |
| ⑩ Remote receiver | Receives signals from the remote control. |
| ⑪ RS-232C port | Connects an RS-232C cable to control the projector from a computer. (You do not need to use this port normally.) |
| ⑫ Monitor Out port | Outputs analog RGB signals input from the Computer1 port to an external monitor. You cannot output signals input from other ports or component video signals. |
| ⑬ Audio Out port | Outputs audio from the current input source to an external speaker. |
| ⑭ Audio 2 port | Inputs audio from equipment connected to the Computer2 port. |
| ⑮ Speaker | Outputs audio. |

► Related Links

- "Projector Connections" [p.20](#)

Projector Parts - Base

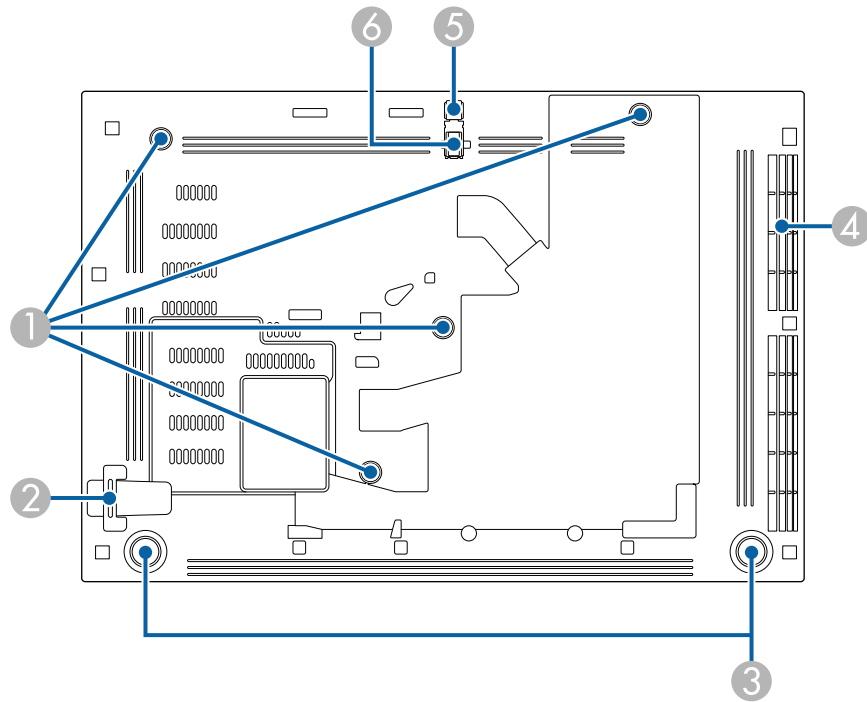

| Name | Function |
|--------------------------------|--|
| ③ Rear feet | When the projector is set up on a surface such as a desk, turn to extend and retract the feet to adjust the horizontal tilt. |
| ④ Air intake vent (air filter) | Takes in air to cool the projector internally. |
| ⑤ Foot release lever | Press the foot release lever to extend and retract the front adjustable foot. |
| ⑥ Front adjustable foot | When the projector is set up on a surface such as a desk, extend the foot to adjust the position of the image. |

► **Related Links**

- "Adjusting the Image Height" [p.41](#)

| Name | Function |
|---|---|
| ① Ceiling mount/Floor stand fixing point or Lighting Track Mount fixing point | Attach the optional Ceiling mount/Floor stand or Lighting Track Mount here. |
| ② Security cable attachment point | Pass a commercially available wire lock through here and lock it in place. You can also attach the optional safety wire here to prevent the projector from falling from the ceiling or wall. |

Projector Parts - Top

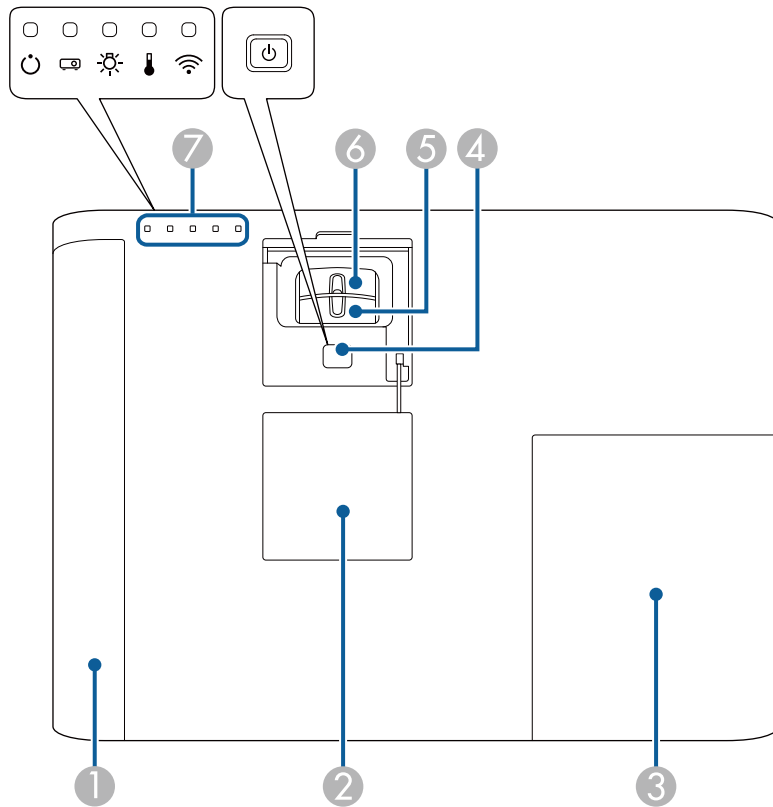

| Name | Function | |
|------|------------|-----------------------------------|
| 6 | Focus ring | Adjusts the image focus. |
| 7 | Indicators | Indicates the projector's status. |

► Related Links

- "Projector Indicator Status" [p.166](#)
- "Resizing the Image with the Zoom Ring" [p.45](#)
- "Focusing the Image Using the Focus Ring" [p.47](#)

| Name | Function | |
|------|--|---|
| 1 | Air filter cover | Open to access the air filter. |
| 2 | Power button cover | Open to access the power button, zoom ring, and focus ring. |
| 3 | Lamp cover | Open to access the projector's lamp. |
| 4 | Power button [] | Turns the projector on or off. |
| 5 | Zoom ring | Adjusts the image size. |

Projector Parts - Remote Control

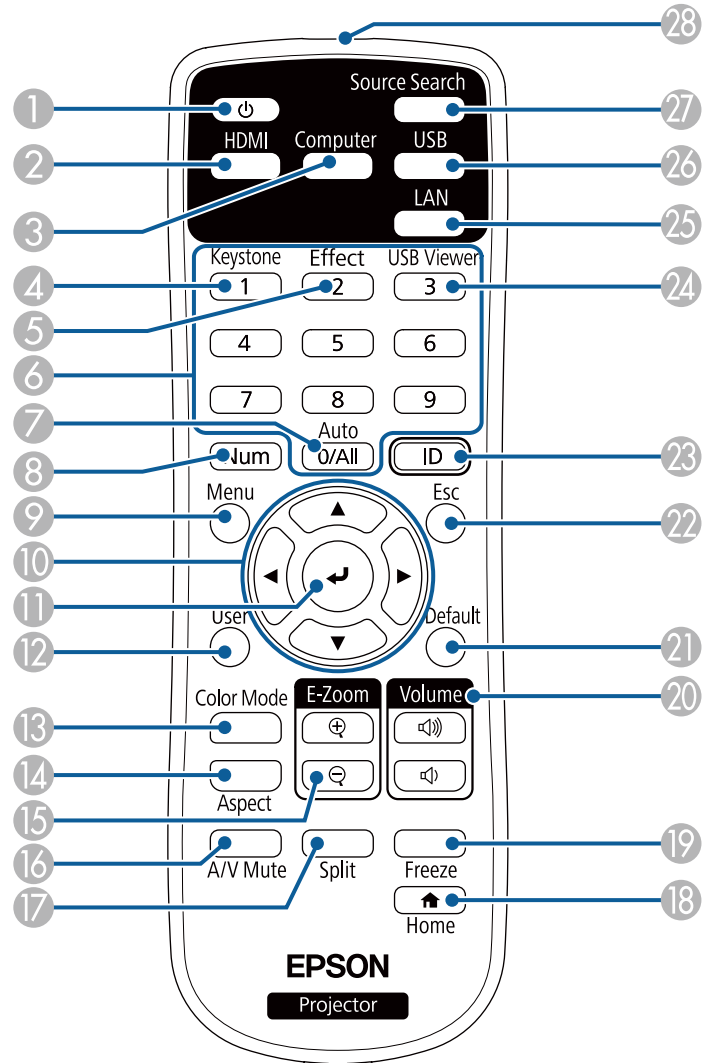

| Name | Function |
|------------------------|---|
| ① Power button [⏻] | Turns the projector on or off. |
| ② [HDMI] button | Switches the image source between the HDMI ports. |
| ③ [Computer] button | Switches the image source between the Computer1 and Computer2 ports. |
| ④ [Keystone] button | Displays the Keystone screen allowing you to correct keystone distortion of the projected image. |
| ⑤ [Effect] button | Displays the Overlay Effect menu in Content Playback mode. |
| ⑥ Numeric buttons | Allows you to enter numbers in the projector's menu while holding down the [Num] button. In Content Playback mode, enter numbers while holding down the [Num] button to play back your favorite playlists. |
| ⑦ [Auto] button | Optimizes Tracking , Sync. , and Position in the projector's Signal menu while projecting an analog RGB signal from the Computer port. |
| ⑧ [Num] button | Hold down this button to enter numbers using the numeric buttons. |
| ⑨ [Menu] button | Displays and closes the projector's menu. |
| ⑩ Arrow buttons | Selects menu items while displaying the projector's menu or help. |
| ⑪ [Enter] button [↵] | Enters the current selection and moves to the next level while displaying the projector's menu or help. |
| ⑫ [User] button | Performs settings assigned in the User Button setting in the projector's Settings menu. |
| ⑬ [Color Mode] button | Changes the color mode. |
| ⑭ [Aspect] button | Changes the aspect mode. |
| ⑮ [E-Zoom] +/- buttons | Resizes the projected image. |
| ⑯ [A/V Mute] button | Turns the video and audio on or off temporarily. |
| ⑰ [Split] button | Projects two images from different image sources simultaneously by splitting the projected screen. |
| ⑱ Freeze | |
| ⑲ [Home] | |
| ⑳ [Volume] | |
| ㉑ [Default] | |
| ㉒ [Esc] | |
| ㉓ [ID] | |
| ㉔ [USB Viewer] | |
| ㉕ [LAN] | |
| ㉖ [USB] | |
| ㉗ [Computer] | |
| ㉘ [HDMI] | |
| ㉙ [Power] | |

| Name | | Function |
|------|------------------------------------|--|
| 18 | [Home] button | Displays and closes the Home screen. |
| 19 | [Freeze] button | Pauses or resumes images. |
| 20 | [Volume] up/down buttons | Adjusts the speaker volume. |
| 21 | [Default] button | Returns the selected setting to its default value. |
| 22 | [Esc] button | Stops the current function. Moves back to the previous menu level while displaying the projector's menu. |
| 23 | [ID] button | Hold down this button and press the numeric buttons to select the ID for the projector you want to operate using the remote control. |
| 24 | [USB Viewer] button | Starts the USB Viewer in Content Playback mode. |
| 25 | [LAN] button | Switches the image source between the network connected devices. |
| 26 | [USB] button | Switches the image source between the USB Display and USB-A port. |
| 27 | [Source Search] button | Switches to the next input source. |
| 28 | Remote control light emitting area | Outputs remote control signals. |

» Related Links

- "Image Aspect Ratio" [p.49](#)
- "Adjusting Image Quality (Color Mode)" [p.51](#)
- "Input Signal Settings - Signal Menu" [p.130](#)
- "Projector Setup Settings - Extended Menu" [p.133](#)
- "Home Screen" [p.32](#)
- "Projecting Two Images Simultaneously" [p.55](#)
- "Projecting a PC Free Presentation" [p.58](#)
- "Using the Projector on a Network" [p.85](#)

Setting Up the Projector

Follow the instructions in these sections to set up your projector.

► **Related Links**

- "Projector Placement" [p.17](#)
- "Projector Connections" [p.20](#)
- "Attaching the Interface Cover" [p.27](#)
- "Installing Batteries in the Remote Control" [p.28](#)
- "Remote Control Operation" [p.29](#)

You can install the projector on a wall, or place it on a table to project images.

You need the optional mounts when suspending the projector from a ceiling or a wall, or installing it on a floor.

Note the following points when selecting a projector location:

- Place the projector on a sturdy, level surface or install it using a compatible mount.
- Leave plenty of space around and under the projector for ventilation, and do not place it on top of or next to anything that could block the vents.
- Place the projector parallel to the screen.



If you cannot install the projector parallel to the screen, correct keystone distortion using the projector controls.

⚠ Warning

- A special method of installation is required when suspending the projector from a wall or ceiling. If you do not install the projector correctly, it could fall and cause damage or injury.
- Do not use adhesives on the fixing points for the optional mounts to prevent the screws from loosening, or use lubricants, oils, or similar substances on the projector; the projector case may crack causing it to fall from its mount. This could cause serious injury to anyone under the mount and could damage the projector.
- Do not cover the projector's air intake or air exhaust vents. If the vents are covered, the internal temperature could rise and cause a fire.
- Do not install the projector on an unstable surface or in a location beyond the weight specifications of the projector. Otherwise, it could fall or topple causing an accident and injury.
- When installing the projector in a high position, take measures to prevent falling by using wires to ensure safety in an emergency, such as an earthquake, and to prevent accidents. If it is not installed correctly, it could fall causing an accident and injury.
- Do not install the projector in locations exposed to high humidity and dust, such as on a kitchen counter, in the kitchen, or near a humidifier, or in locations exposed to oil smoke or steam. Doing so could cause fire or electric shock. In addition, the oil content could cause the projector's outer case to deteriorate and could cause the projector to fall off from the ceiling where it is suspended.

Attention

- If you are using the projector at altitudes above 1500 m, set the **High Altitude Mode** setting to **On** in the projector's menu to ensure the projector's internal temperature is regulated properly.
 - ☛ **Extended > Operation > High Altitude Mode**
- Try not to setup the projector in locations subject to high humidity and dust, or in locations subject to smoke from fires or tobacco smoke.

» Related Links

- "Projector Setup and Installation Options" [p.17](#)
- "Projection Distance" [p.19](#)
- "Image Shape" [p.42](#)
- "Projector Setup Settings - Extended Menu" [p.133](#)

Projector Setup and Installation Options

You can set up or install your projector in the following ways:

Front/Rear

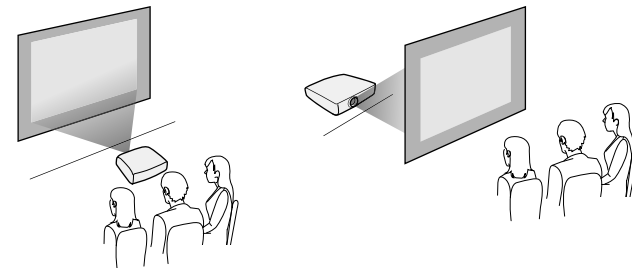

Front Ceiling/Rear Ceiling

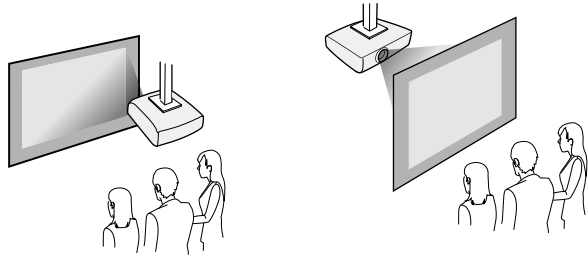

Make sure you select the correct **Projection** option in the projector's **Extended** menu according to the installation method being used.

» Related Links

- "Precautions on Installation" [p.18](#)
- "Projection Modes" [p.38](#)

Precautions on Installation

Note the following precautions when installing the projector.

Installation space

Attention

Be sure to leave the following amount of space around the projector so as not to block the air exhaust and intake vents.

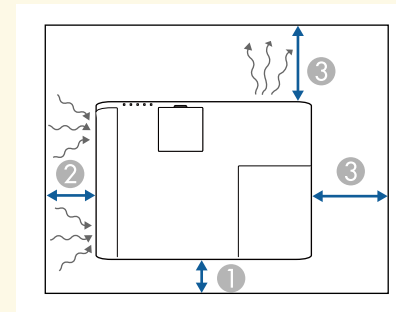

- ① 10 cm
- ② 20 cm
- ③ 30 cm

Installation space (When installing multiple projectors side by side)

Attention

If you are installing multiple projectors next to each other, make sure hot air from the exhaust vent does not go into the air intake vent of another projector.

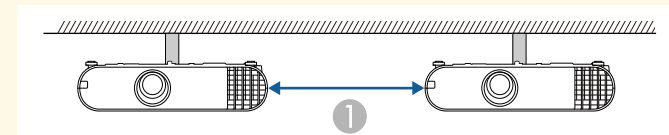

- ① 30 cm

Projection Distance

The distance at which you place the projector from the screen determines the approximate size of the image. The image size increases the farther the projector is from the screen, but can vary depending on the zoom factor, aspect ratio, and other settings.

See the Appendix for details about how far to place the projector from the screen based on the size of the projected image.



When correcting keystone distortion, your image is slightly smaller.

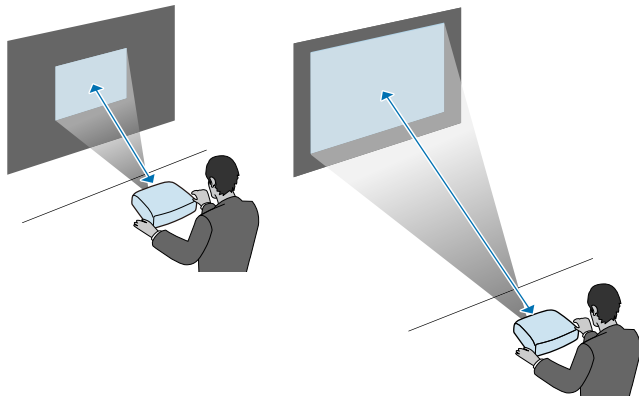

► Related Links

- "Screen Size and Projection Distance" [p.184](#)

See these sections to connect the projector to a variety of projection sources.

Attention

Check the shape and orientation of the connectors on any cable you plan to connect. Do not force a connector into a port if it does not fit. The device or your projector could be damaged or could malfunction.



See the *Quick Reference* for a list of cables supplied with your projector. Purchase optional or commercially available cables when necessary.

» Related Links

- "Connecting to a Computer" [p.20](#)
- "Connecting to Video Sources" [p.22](#)
- "Connecting to External USB Devices" [p.24](#)
- "Connecting to a Document Camera" [p.25](#)
- "Connecting to External Output Devices" [p.25](#)

Connecting to a Computer

Follow the instructions in these sections to connect a computer to the projector.

» Related Links

- "Connecting to a Computer for VGA Video and Audio" [p.20](#)
- "Connecting to a Computer for USB Video and Audio" [p.21](#)
- "Connecting to a Computer for HDMI Video and Audio" [p.22](#)

Connecting to a Computer for VGA Video and Audio

You can connect the projector to your computer using a VGA computer cable.

You can play sound through the projector's speaker system by connecting a commercially available 3.5 mm stereo mini-jack audio cable.



- To connect a computer that does not have a VGA video port, you need an adapter that allows you to connect to the projector's VGA video port.
- You can also set the port used for audio input in the projector's **Extended** menu.
 - **Extended > A/V Settings > Audio Settings > Audio Output**
- Make sure the audio cable is labeled "No resistance".

1 Connect the VGA computer cable to your computer's monitor port.

2 Connect the other end to a Computer port on the projector.

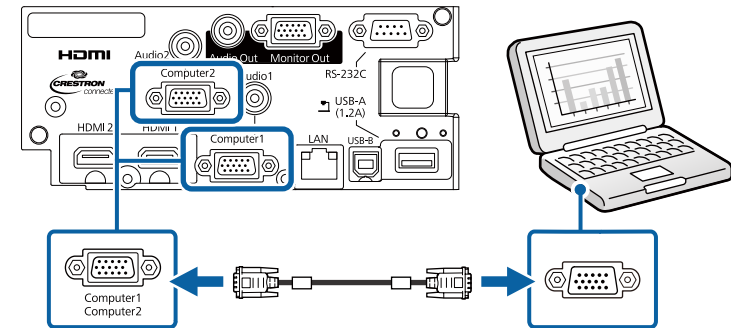

3 Tighten the screws on the VGA connector.

4 Connect the audio cable to your laptop's headphone or audio-out jack, or your desktop's speaker or audio-out port.

- 5** Connect the other end to the Audio port that corresponds to the Computer port you are using.

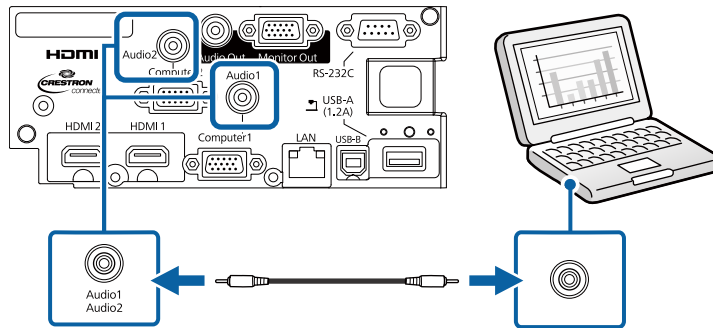

» **Related Links**

- "Projector Setup Settings - Extended Menu" [p.133](#)

Connecting to a Computer for USB Video and Audio

If your computer meets the system requirements, you can send video and audio output to the projector through the computer's USB port. This function is called USB Display. Connect the projector to your computer using a USB cable.

 • If you use a USB hub, the connection may not operate correctly. Connect the USB cable directly to the projector.

- 1** Connect the cable to your projector's USB-B port.

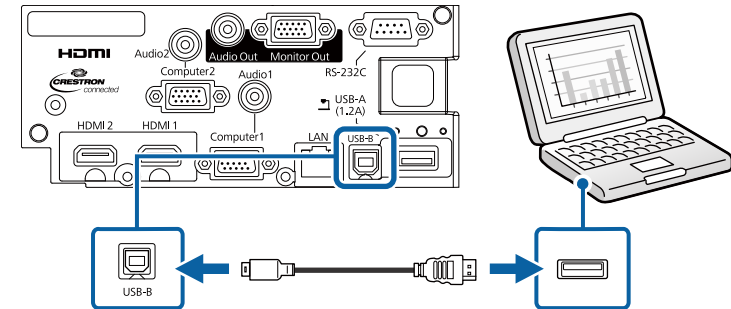

- 2** Connect the other end to any available USB port on your computer.
- 3** Turn on the projector and your computer.
- 4** Do one of the following to install the Epson USB Display software:

 You only need to install this software the first time you connect the projector to the computer.

- Windows: Select **Run EMP_UDSE.EXE** in the dialog box that is displayed to install the Epson USB Display software.
 - Mac: The Epson USB Display setup folder is displayed on your screen. Select **USB Display Installer** and follow the on-screen instructions to install the Epson USB Display software. If the USB Display **Setup** folder is not displayed automatically, double-click **EPSON_PJ_UD > USB Display Installer**.
- 5** Follow any on-screen instructions.
Do not disconnect the USB cable or turn off the projector until the projector displays an image.

The projector displays the image from your computer's desktop and outputs sound if your presentation contains audio.



- If the projector does not project any images, do one of the following:
 - Windows: Click **All Programs > EPSON Projector > Epson USB Display > Epson USB Display Ver.x.xx**.
 - Mac: Double-click the **USB Display** icon in the **Application** folder.
- When you finish projection, do one of the following:
 - Windows: Disconnect the USB cable. You do not need to operate **Safely Remove Hardware**.
 - Mac: Select **Disconnect** from the **USB Display** icon menu on the menu bar or **Dock**, and then disconnect the USB cable.



- If you have problems hearing audio through the HDMI connection, connect one end of a commercially available 3.5 mm stereo mini-jack audio cable to the projector's Audio port and the other end to your computer's audio out port. Select the audio input port you connected to in the projector's **Extended** menu.
- **Extended > A/V Settings > Audio Settings > HDMI1 Audio Output**
 - **Extended > A/V Settings > Audio Settings > HDMI2 Audio Output**

» Related Links

- "USB Display System Requirements" [p.192](#)

» Related Links

- "Projector Setup Settings - Extended Menu" [p.133](#)

Connecting to a Computer for HDMI Video and Audio

If your computer has an HDMI port, you can connect it to the projector using an HDMI cable and send the computer's audio with the projected image.



To connect a Mac that does not have an HDMI port, you need an adapter that allows you to connect to the projector's HDMI port. Contact Apple for compatible adapter options. Older Mac computers (2009 and earlier) may not support audio through the HDMI port.

- 1** Connect the HDMI cable to your computer's HDMI output port.
- 2** Connect the other end to the projector's HDMI port.

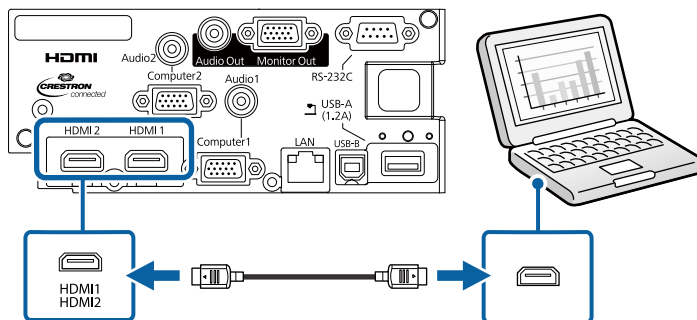

Connecting to Video Sources

Follow the instructions in these sections to connect video devices to the projector.



- If the port on the device you connect has an unusual shape, use the cable supplied with the device or an optional cable to connect to the projector.
- The cable differs depending on the output signal from the connected video devices.
- Some video devices are capable of outputting different types of signals. See your video device manual to confirm what type of signals can be output.

» Related Links

- "Connecting to an HDMI Video Source" [p.22](#)
- "Connecting to a Component-to-VGA Video Source" [p.23](#)

Connecting to an HDMI Video Source

If your video source has an HDMI port, you can connect it to the projector using an HDMI cable and send the image source's audio with the projected image.

Attention

Do not turn on the video source before connecting it to the projector. Doing so could damage the projector.

- 1** Connect the HDMI cable to your video source's HDMI output port.
- 2** Connect the other end to the projector's HDMI port.

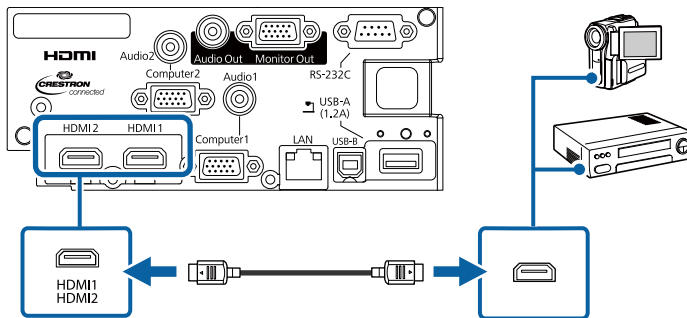

If you have problems hearing audio through the HDMI connection, connect one end of a commercially available 3.5 mm stereo mini-jack audio cable to the projector's Audio port and the other end to your video source's audio out port. Select the audio input port you connected to in the projector's **Extended** menu.

- ☛ **Extended > A/V Settings > Audio Settings > HDMI1 Audio Output**
- ☛ **Extended > A/V Settings > Audio Settings > HDMI2 Audio Output**

» Related Links

- "Projector Setup Settings - Extended Menu" [p.133](#)

Connecting to a Component-to-VGA Video Source

If your video source has component video ports, you can connect it to the projector using a component-to-VGA video cable. Depending on your

component ports, you may need to use an adapter cable along with a component video cable.

You can play sound through the projector's speaker system by connecting a stereo mini-jack audio cable.



- You can also set the port used for audio input in the projector's **Extended** menu.
☛ **Extended > A/V Settings > Audio Settings > Audio Output**
- Make sure the audio cable is labeled "No resistance".

- 1** Connect the component connectors to your video source's color-coded component video output ports.



The ports usually labeled Y, Pb, Pr or Y, Cb, Cr. If you are using an adapter, connect these connectors to your component video cable.

- 2** Connect the VGA connector to a Computer port on the projector.

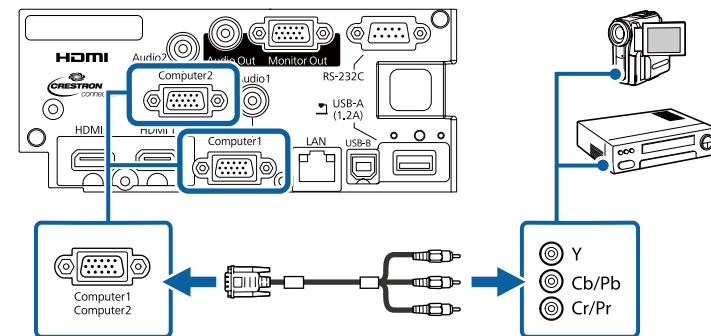

- 3** Tighten the screws on the VGA connector.

- 4** Connect the audio cable to your video source's audio-out ports.

- 5** Connect the other end to the projector's Audio port.

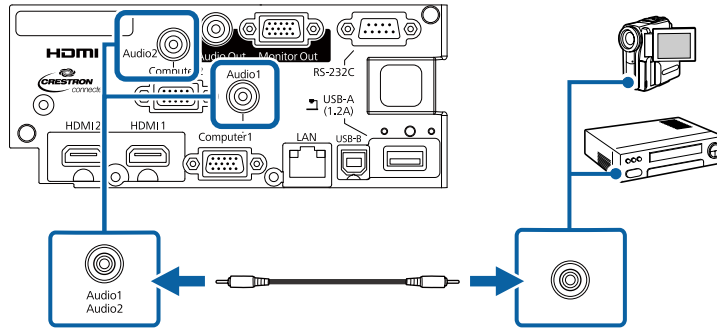

If your image colors appear incorrectly, you may need to change the **Input Signal** setting in the projector's **Signal** menu.

☛ **Signal > Advanced > Input Signal**

» **Related Links**

- "Input Signal Settings - Signal Menu" [p.130](#)
- "Projector Setup Settings - Extended Menu" [p.133](#)

Connecting to External USB Devices

Follow the instructions in these sections to connect external USB devices to the projector.

» **Related Links**

- "USB Device Projection" [p.24](#)
- "Connecting to a USB Device" [p.24](#)
- "Disconnecting a USB Device" [p.25](#)

USB Device Projection

You can project images and other content without using a computer or video device by connecting any of these devices to your projector:

- USB flash drive
- Digital camera or smartphone
- USB hard drive
- Multimedia storage viewer



- Digital cameras or smartphones must be USB-mounted devices, not TWAIN-compliant devices, and must be USB Mass Storage Class-compliant.
- USB hard drives must meet these requirements:
 - USB Mass Storage Class-compliant (not all USB Mass Storage Class devices are supported)
 - Formatted in FAT16/32
 - Self-powered by their own AC power supplies (bus-powered hard drives are not recommended)
 - Avoid using hard drives with multiple partitions

You can project slide shows from image files on a connected USB device.

You can also project playlists that contain images and movies saved on a USB flash drive in Content Playback mode.

» **Related Links**

- "Projecting in Content Playback Mode" [p.63](#)
- "Projecting a PC Free Presentation" [p.58](#)

Connecting to a USB Device

You can connect your USB device to the projector's USB-A port and use it to project images and other content.

- 1** If your USB device came with a power adapter, plug the device into an electrical outlet.

- 2 Connect the USB cable or USB flash drive to the projector's USB-A port as shown.

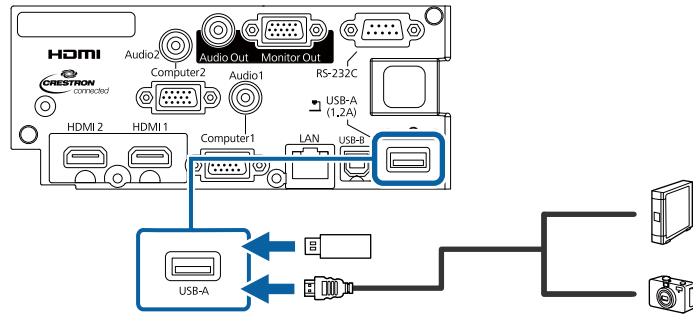

Attention

- Use the USB cable supplied with or specified for use with the device.
- Do not connect a USB hub or a USB cable longer than 3 meters, or the device may not operate correctly.

- 3 Connect the other end to your device, if necessary.

Disconnecting a USB Device

When you have finished presenting with a connected USB device, disconnect the device from the projector.

- 1 Turn off and unplug the device, if necessary.
- 2 Disconnect the USB device from the projector.

Connecting to a Document Camera

You can connect a document camera to your projector to project images viewed by the camera.

The connection method varies depending on your Epson document camera model. See the document camera manual for details.

Connecting to External Output Devices

Follow the instructions in these sections to connect external devices to the projector.

► Related Links

- "Connecting to a VGA Monitor" p.25
- "Connecting to External Speakers" p.26

Connecting to a VGA Monitor

If you connected the projector to a computer using a Computer port, you can also connect an external monitor to the projector. This lets you see your presentation on the external monitor even when the projected image is not visible.



- If you want to output images to an external monitor when the projector is turned off, select **Always On** as the **A/V Output** setting in the projector's **Extended** menu.
 ● **Extended > A/V Settings > A/V Output**
- Monitors that use a refresh rate of less than 60 Hz may not be able to display images correctly.



- 1 Make sure your computer is connected to the projector's Computer port.



- If there are two computer ports, make sure you use the Computer1 port.
- Only analog RGB signals from the Computer1 port can be output to an external monitor. You cannot output signals input from other ports or component video signals.

- 2 Connect the external monitor's cable to your projector's Monitor Out port.

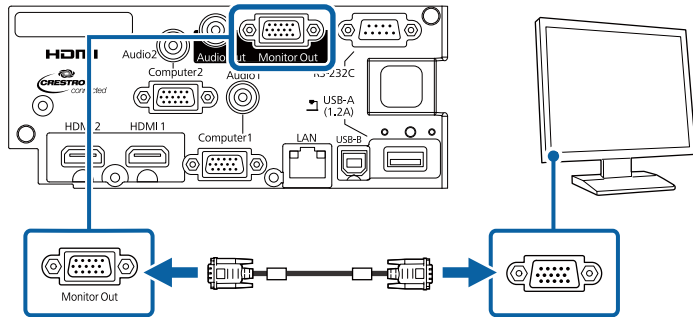

» Related Links

- "Projector Setup Settings - Extended Menu" [p.133](#)

Connecting to External Speakers

To enhance the sound from your presentation, you can connect the projector to external self-powered speakers. You can control the volume using the projector's remote control.



- If you want to output audio from the external speakers when the projector is turned off, select **Always On** as the **A/V Output** setting in the projector's **Extended** menu.
 - **Extended > A/V Settings > A/V Output**
- You can also connect the projector to an amplifier with speakers.
- The projector's built-in speaker system is disabled when you connect external speakers.

- 1 Make sure your computer or video source is connected to the projector with both audio and video cables as necessary.
- 2 Locate the appropriate cable to connect your external speakers, such as a stereo mini-jack-to-pin-jack cable, or another type of cable or adapter.

- 3 Connect one end of the cable to your external speakers as necessary.

- 4 Connect the stereo mini-jack end of the cable to your projector's Audio Out port.

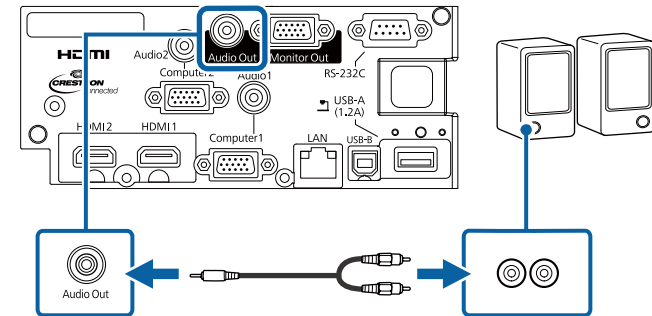

» Related Links

- "Projector Setup Settings - Extended Menu" [p.133](#)

You can attach the interface cover that came with your projector so that the rear of the projector looks simple and neat.

- 1** Open the slots on the interface cover to which you want to connect cables.

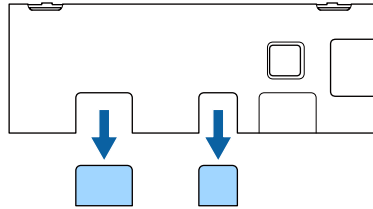

- 2** Attach the interface cover on the projector as shown.

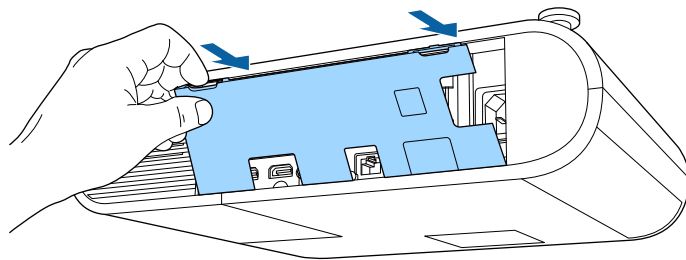

- 3** Connect the power cable and other cables to the projector.

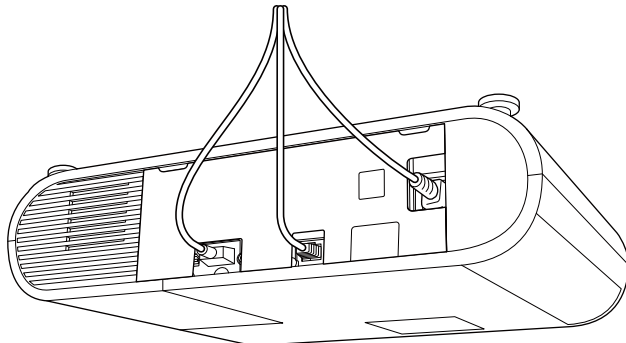

The remote control uses the two AA batteries that came with the projector.

Attention

Make sure you read the *Safety Instructions* before handling the batteries.

- 1 Remove the battery cover as shown.

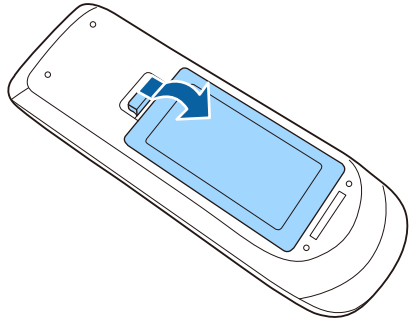

- 2 Remove the old batteries, if necessary.



Dispose of used batteries according to local regulations.

- 3 Insert the batteries with the + and – ends facing as shown.

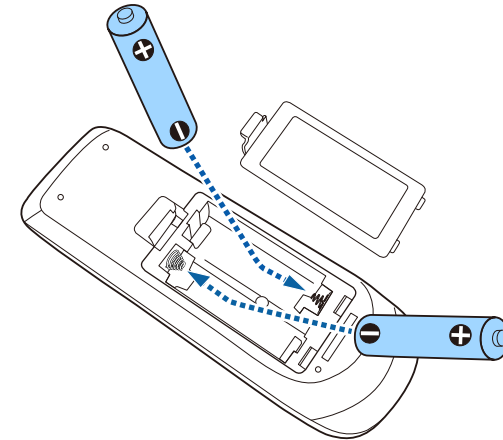

Warning

Check the positions of the (+) and (-) marks inside the battery holder to ensure the batteries are inserted the correct way. If the batteries are not used correctly, they could explode or leak causing a fire, injury, or damage to the product.

- 4 Replace the battery cover and press it down until it clicks into place.

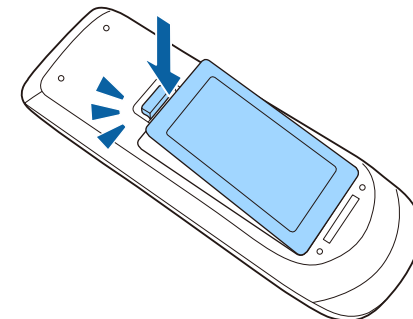

The remote control lets you control the projector from almost anywhere in the room.

Make sure that you aim the remote control at the projector's receivers within the distance and angles listed here.

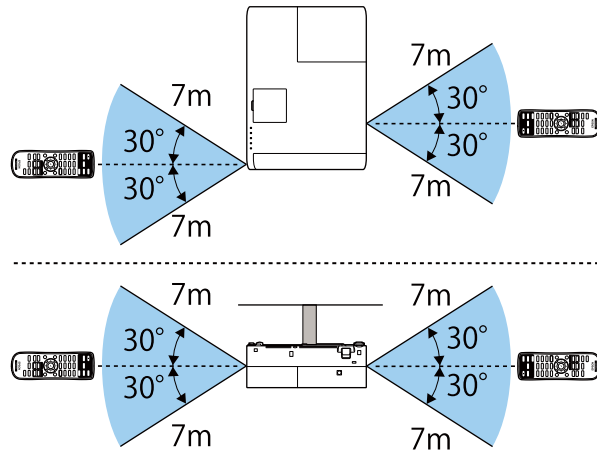

Avoid using the remote control in conditions with bright fluorescent lights or in direct sunlight, or the projector may not respond to commands. If you are not going to use the remote control for a long time, remove the batteries.

Using Basic Projector Features

Follow the instructions in these sections to use your projector's basic features.

► Related Links

- "Turning On the Projector" [p.31](#)
- "Turning Off the Projector" [p.34](#)
- "Setting the Date and Time" [p.35](#)
- "Selecting the Language for the Projector Menus" [p.37](#)
- "Projection Modes" [p.38](#)
- "Displaying a Test Pattern" [p.40](#)
- "Adjusting the Image Height" [p.41](#)
- "Image Shape" [p.42](#)
- "Resizing the Image with the Zoom Ring" [p.45](#)
- "Adjusting the Image Position" [p.46](#)
- "Focusing the Image Using the Focus Ring" [p.47](#)
- "Selecting an Image Source" [p.48](#)
- "Image Aspect Ratio" [p.49](#)
- "Adjusting Image Quality (Color Mode)" [p.51](#)
- "Controlling the Volume with the Volume Buttons" [p.53](#)

Turn on the computer or video equipment you want to use after you turn on the projector.

- 1** Connect the power cord to the projector's power inlet and plug it into an electrical outlet.

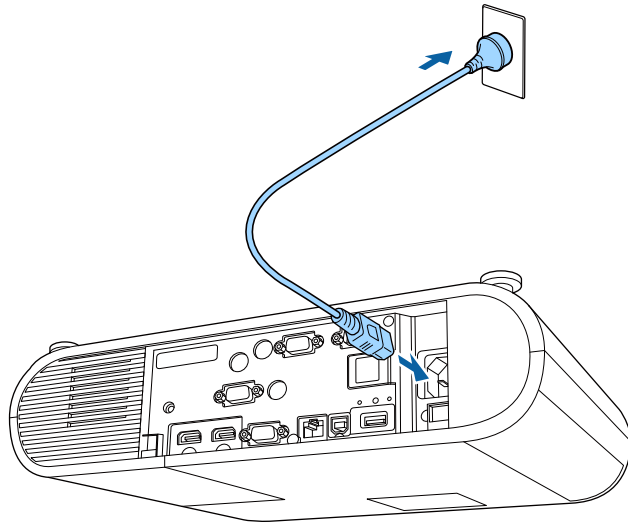

The projector's power indicator turns blue. This indicates that the projector is receiving power, but is not yet turned on (it is in standby mode).

- 2** Press the power button on the projector or remote control to turn on the projector.

The projector beeps and the status indicator flashes blue as the projector warms up. Once the projector is warmed up, the status indicator stops flashing and turns blue.

Try the following if you do not see a projected image.

- Turn on the connected computer or video device.

- Change the screen output from the computer when using a laptop computer.
- Insert a DVD or other video media, and press play (if necessary).
- Press the [Source Search] button on the remote control to detect the source.
- Press the button for the desired video source on the remote control.
- If the Home screen is displayed, select the source you want to project.

⚠ Warning

- Never look into the projector lens when the lamp is on. This can damage your eyes and is especially dangerous for children.
 - When turning on the projector at a distance using the remote control, make sure there is no one looking into the lens.
 - During projection, do not block the light from the projector with a book or other objects. If the light from the projector is blocked, the area on which the light shines becomes hot which could cause it to melt, burn, or start a fire. Also, the lens may get hot due to the reflected light which could cause the projector to malfunction. To stop projection, use the A/V Mute function, or turn off the projector.
 - A mercury lamp with high internal pressure is used as the projector's light source. If the lamp is subjected to vibrations or shocks, or if it is used for an overly extended length of time, the lamp may break or it may not turn on. If the lamp explodes, gases may escape and small fragments of glass may be scattered which could cause an injury. Be sure to observe the instructions below.
 - Do not disassemble or damage the lamp or subject it to any impacts.
 - Do not bring your face close to the projector while it is in use.
 - Particular care should be taken when the projector is installed to a ceiling, as small pieces of glass may fall down when the lamp cover is removed. When cleaning the projector or replacing the lamp yourself, be very careful not to allow such pieces of glass to get into the eyes or mouth.
- If the lamp breaks, ventilate the area immediately, and contact a doctor if any fragments of broken glass are inhaled or get into the eyes or mouth.



- When the **Direct Power On** setting is set to **On** in the projector's **Extended** menu, the projector turns on as soon as you plug it in. Note that the projector also turns on automatically in cases such as recovery from a power outage.
 - ☛ **Extended > Operation > Direct Power On**
- If you select a specific port as the **Auto Power On** setting in the projector's **Extended** menu, the projector turns on as soon as it detects a signal or cable connection from that port.
 - ☛ **Extended > Operation > Auto Power On**

► Related Links

- "Home Screen" [p.32](#)
- "Projector Setup Settings - Extended Menu" [p.133](#)

Home Screen

The Home screen feature allows you to easily select an image source and access useful functions. You can display the Home screen by pressing the [Home] button on the remote control. The Home screen is also displayed when you turn on the projector and no signal is being input.

Press the arrow buttons on the remote control to select a menu item, and then press [Enter].

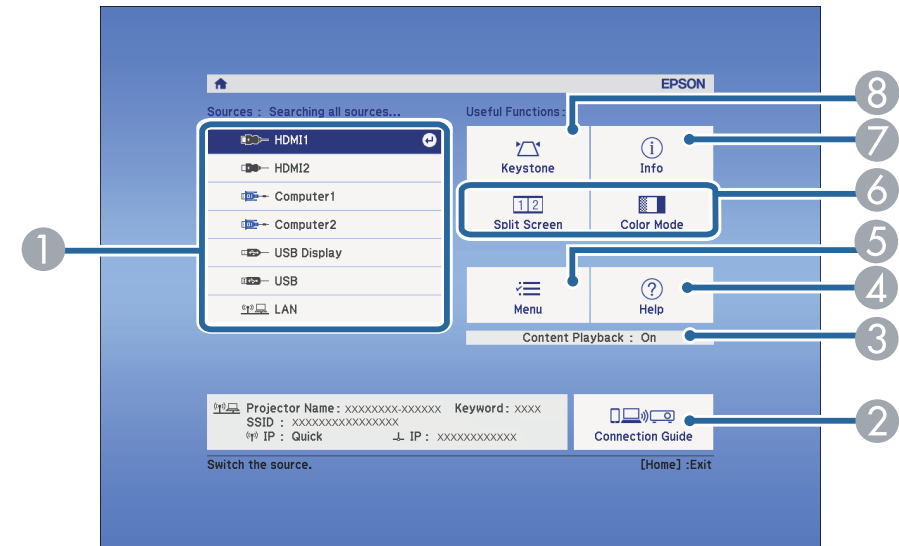

- 1 Selects the source you want to project.
- 2 Displays the Connection Guide. You can select the wireless connection methods according to the devices you are using, such as smartphones or computers.
- 3 Indicates the projector is in Content Playback mode.
- 4 Displays the Help screen.
- 5 Displays the projector's menu.
- 6 Performs menu options assigned to **Home Screen** in the projector's **Extended** menu.
- 7 Displays the projector information.
- 8 Corrects the shape of an image that is an uneven rectangle.



The Home screen disappears after 10 minutes of inactivity.

» Related Links

- "Image Shape" [p.42](#)
- "Projector Setup Settings - Extended Menu" [p.133](#)
- "Using the Projector's Menus" [p.126](#)
- "Using the Projector Help Displays" [p.169](#)
- "Projecting Two Images Simultaneously" [p.55](#)

Turn off the projector after use.



- Turn off this product when it is not in use to prolong the life of the projector. Lamp life varies depending on the mode selected, environmental conditions, and usage. Brightness decreases over time.
- Since the projector supports the direct shutdown feature, it can be turned off directly using the breaker.

- 1** Press the power button on the projector or remote control.
The projector displays a shutdown confirmation screen.

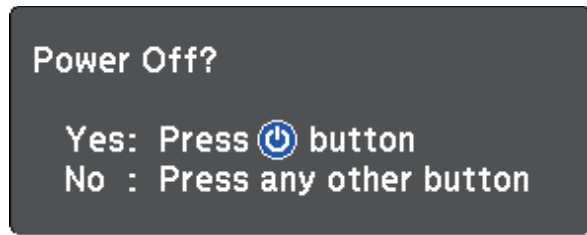

- 2** Press the power button again. (To leave it on, press any other button.)
The projected image disappears, the projector beeps twice, and the status indicator turns off.



With Epson's Instant Off technology, there is no cool-down period so you can pack up the projector for transport right away.

- 3** To transport or store the projector, make sure the power indicator is blue (but not flashing) and the status indicator is off, then unplug the power cord.

You can set the date and time for the projector.

- 1 Turn on the projector.
- 2 Press the [Menu] button on the remote control.
- 3 Select the **Extended** menu and press [Enter].
- 4 Select the **Operation** setting and press [Enter].
- 5 Select the **Date & Time** setting and press [Enter].

You see this screen:

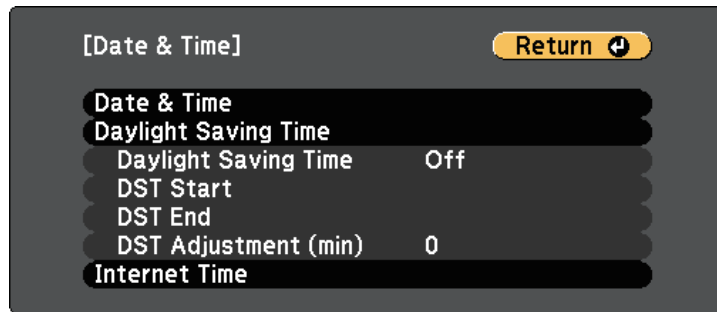

- 6 Select the **Date & Time** setting and press [Enter].

You see this screen:

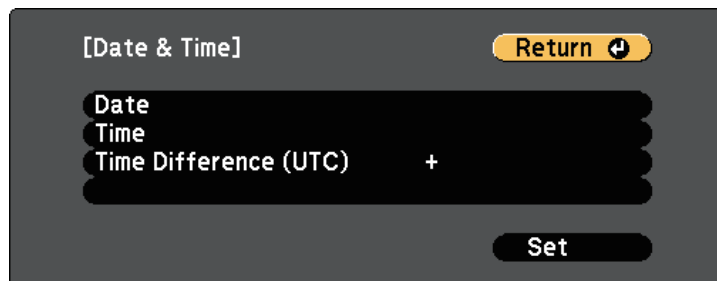

- 7 Select **Date**, press [Enter], and use the displayed keyboard to enter today's date.
- 8 Select **Time**, press [Enter], and use the displayed keyboard to enter the current time.
- 9 Select **Time Difference (UTC)**, press [Enter], and set the time difference from Coordinated Universal Time.
- 10 When you are finished, select **Set** and press [Enter].
- 11 To activate daylight saving time, select the **Daylight Saving Time** setting and press [Enter]. Then select settings.

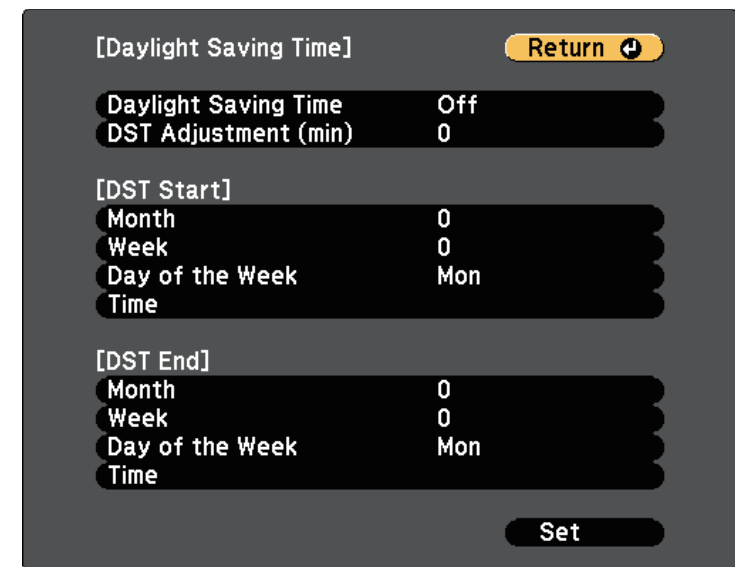

- 12 When you are finished, select **Set** and press [Enter].

- 13** To update the time automatically through an Internet time server, select the **Internet Time** setting and press [Enter]. Then select settings.

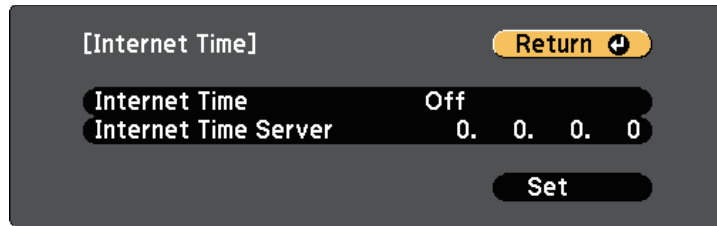

- 14** When you are finished, select **Set** and press [Enter].

- 15** Press [Menu] or [Esc] to exit the menus.

If you want to view the projector's menus and messages in another language, you can change the **Language** setting.

- 1** Turn on the projector.
- 2** Press the [Menu] button on the remote control.
- 3** Select the **Extended** menu and press [Enter].

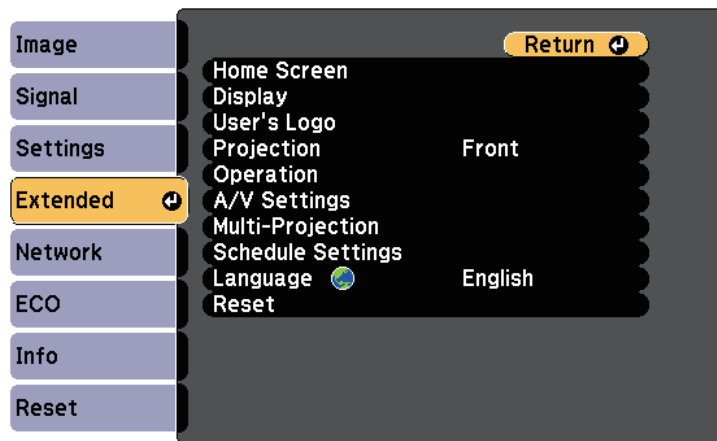

- 4** Select the **Language** setting and press [Enter].
- 5** Select the language you want to use and press [Enter].
- 6** Press [Menu] or [Esc] to exit the menus.

Depending on how you positioned the projector, you may need to change the projection mode so your images project correctly.

- **Front** lets you project from a table in front of the screen.
- **Front/Ceiling** flips the image over top-to-bottom to project upside-down from a ceiling or wall mount.
- **Rear** flips the image horizontally to project from behind a translucent screen.
- **Rear/Ceiling** flips the image over top-to-bottom and horizontally to project from a ceiling or wall mount and behind a translucent screen.

» **Related Links**

- "Changing the Projection Mode Using the Remote Control" [p.38](#)
- "Changing the Projection Mode Using the Menus" [p.38](#)
- "Projector Setup and Installation Options" [p.17](#)

Changing the Projection Mode Using the Remote Control

You can change the projection mode to flip the image over top-to-bottom.

- 1 Turn on the projector and display an image.
- 2 Hold down the [A/V Mute] button on the remote control for 5 seconds.

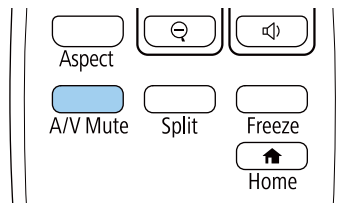

The image disappears briefly and reappears flipped top-to-bottom.

- 3 To change projection back to the original mode, hold down the [A/V Mute] button for 5 seconds again.

Changing the Projection Mode Using the Menus

You can change the projection mode to flip the image over top-to-bottom and/or left-to-right using the projector menus.

- 1 Turn on the projector and display an image.
- 2 Press the [Menu] button on the remote control.
- 3 Select the **Extended** menu and press [Enter].

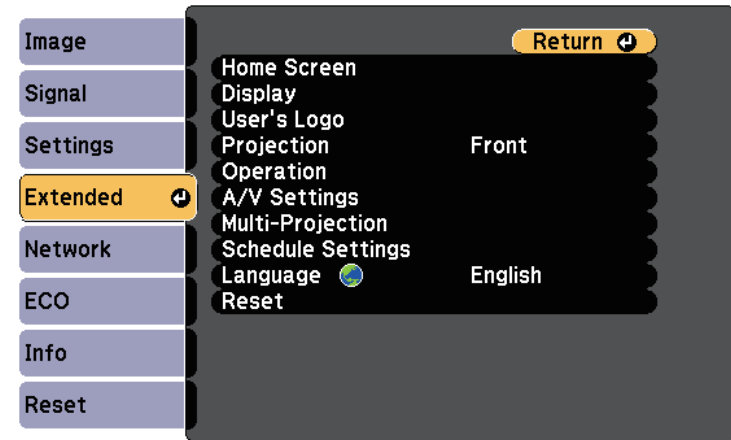

- 4 Select **Projection** and press [Enter].

- 5** Select a projection mode and press [Enter].

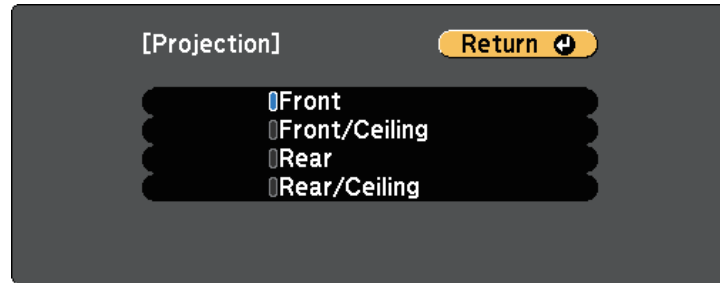

- 6** Press [Menu] or [Esc] to exit the menus.

You can display a test pattern to adjust the projected image without connecting a computer or video device.



To set menu items that cannot be set while the test pattern is being displayed or to fine-tune the projected image, project an image from the connected device.

- 1** Turn on the projector.
- 2** Press the [Menu] button on the remote control.
- 3** Select the **Settings** menu and press [Enter].

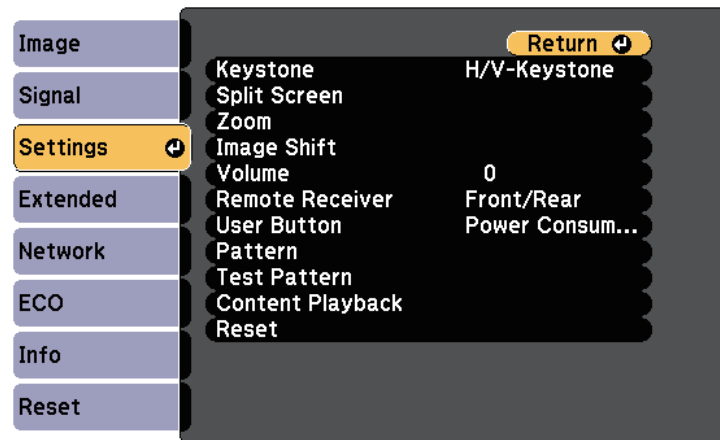

- 4** Select **Test Pattern**.



- 5** Select the pattern you want to display and press [Enter].
The test pattern is displayed.
- 6** While the pattern is displayed, press the left or right arrow button on the remote control or press [Enter] to cycle through the available test patterns.
- 7** Adjust the image as necessary.
- 8** Press [Esc] to clear the test pattern.

If you are projecting from a table or other flat surface and the image is too high or low, you can adjust the image height using the projector's adjustable feet.

The larger the angle of tilt, the harder it becomes to focus. Locate the projector so that it only needs to be tilted at a small angle.

- 1** Turn on the projector and display an image.
- 2** Press the foot release lever to extend and retract the front adjustable foot.

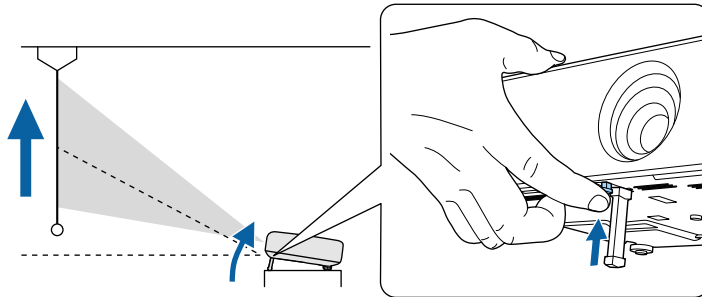

The foot extends from the projector.

You can adjust the position up to approximately 10 degrees.

- 3** Release the lever to lock the foot.

Caution

Be careful not to get your fingers caught between the projector and table or floor.

- 4** If the image is tilted, rotate the rear feet to adjust their height.

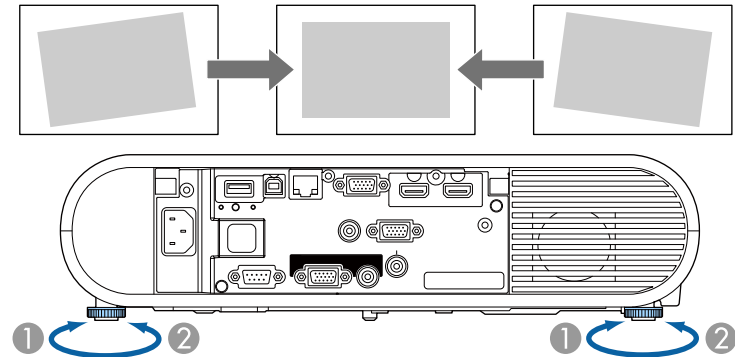

- 1** Extend the rear foot
- 2** Retract the rear foot

If the projected image is unevenly rectangular, you need to adjust the image shape.

► **Related Links**

- "Image Shape" [p.42](#)

You can project an even, rectangular image by placing the projector directly in front of the center of the screen and keeping it level. If you place the projector at an angle to the screen, or tilt it up or down, or off to the side, you may need to correct the image shape.

► Related Links

- "Auto V-Keystone" [p.42](#)
- "Correcting the Image Shape with the Keystone Button" [p.42](#)
- "Correcting the Image Shape with Quick Corner" [p.43](#)

Auto V-Keystone

When the projector is moved or tilted, **Auto V-Keystone** automatically corrects any vertical keystone distortion.

Auto V-Keystone can correct the projected image distortion in these conditions:

- Projection angle is about 30° up or down
- The **Projection** setting is set to **Front** in the projector's **Extended** menu



- If you do not want to use the **Auto V-Keystone** function, set **Auto V-Keystone** to **Off** in the projector's menu.
 ⌨ **Settings > Keystone > H/V-Keystone > Auto V-Keystone**

► Related Links

- "Projection Modes" [p.38](#)
- "Projector Setup Settings - Extended Menu" [p.133](#)
- "Projector Feature Settings - Settings Menu" [p.131](#)

Correcting the Image Shape with the Keystone Button

You can use the [Keystone] button on the remote control to correct the shape of an image that is unevenly rectangular.

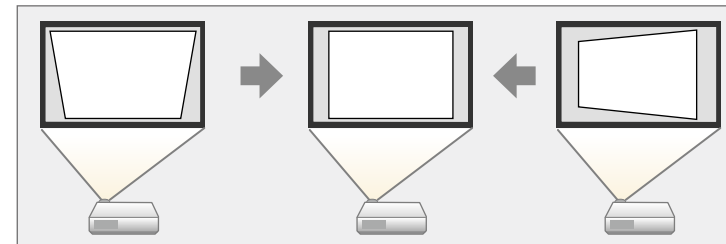

- You cannot combine H/V-Keystone correction with other image shape correction methods.
- You can correct horizontal keystone distortion up to 30° right or left.

- 1** Turn on the projector and display an image.
- 2** Press the [Keystone] button on the remote control, select **H/V-Keystone**, and then press [Enter].

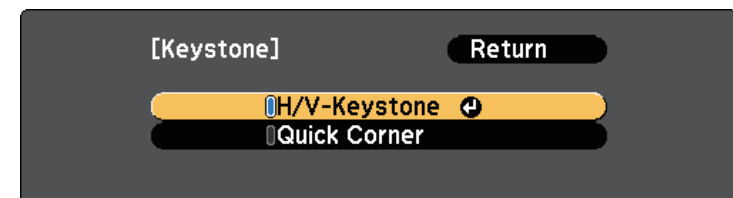

You see the **H/V-Keystone** adjustment screen:



3 Use the arrow buttons on the remote control to select between vertical and horizontal keystone correction and to adjust the image shape as necessary.

• **V-Keystone**

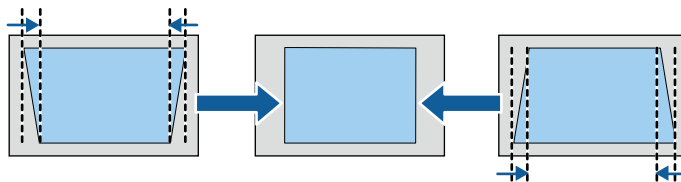

• **H-Keystone**

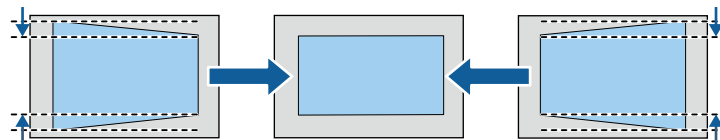

4 When you are finished, press [Esc].

After correction, your image is slightly smaller.

» **Related Links**

- "Projector Feature Settings - Settings Menu" [p.131](#)

Correcting the Image Shape with Quick Corner

You can use the projector's **Quick Corner** setting to correct the shape and size of an image that is unevenly rectangular.

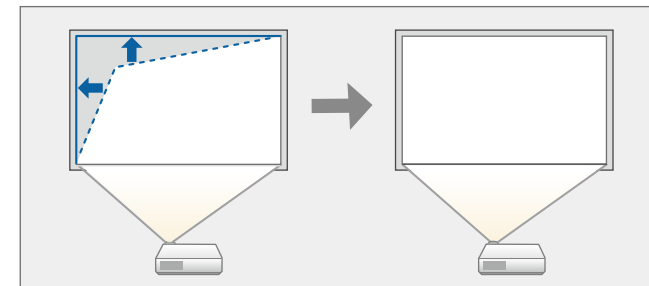

- 1** Turn on the projector and display an image.
- 2** Press the [Keystone] button on the remote control, select **Quick Corner**, and press [Enter]. Then press [Enter] again if necessary.

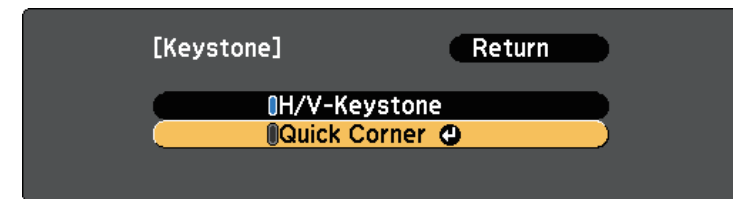

You see the area selection screen.

- 3** Use the arrow buttons to select the corner of the image you want to adjust. Then press [Enter].

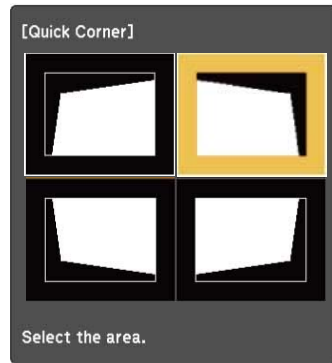

To reset the Quick Corner corrections, hold down [Esc] for about two seconds while the area selection screen is displayed, and then select Yes.

- 4** Press the arrow buttons to adjust the image shape as necessary. To return to the area selection screen, press [Enter].



If you see this screen, you cannot adjust the shape any further in the direction indicated by the gray triangle.

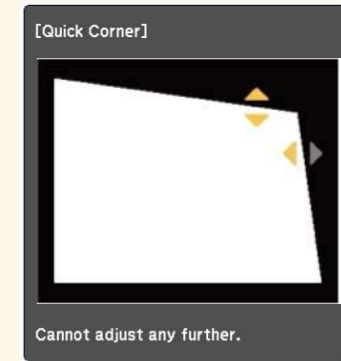

- 5** Repeat steps 3 and 4 as needed to adjust any remaining corners.
- 6** When you are finished, press [Esc].

You can resize the image using the projector's zoom ring.

- 1** Turn on the projector and display an image.
- 2** Open the power button cover.
- 3** Rotate the zoom ring to enlarge or reduce the image.

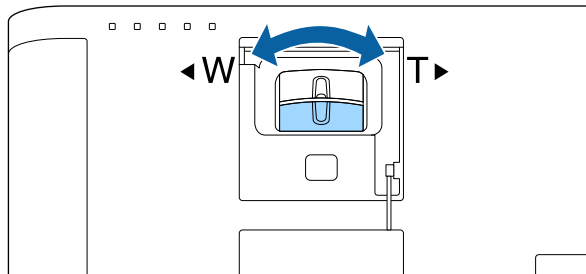
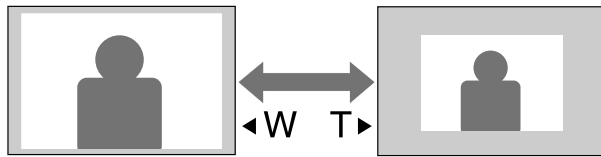

You can use the **Image Shift** feature to adjust the image position without moving the projector.



- This feature is not available if the Zoom option is set to the widest setting.

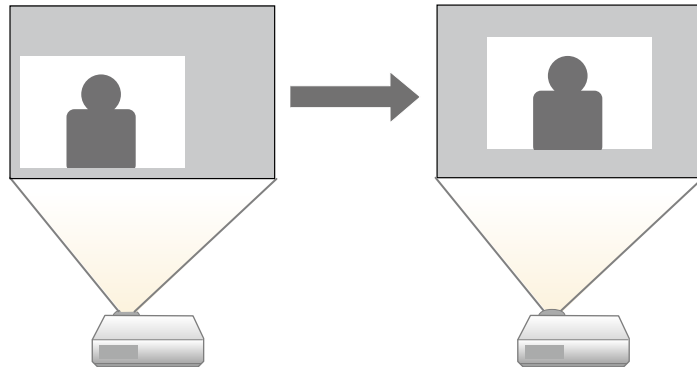

1 Turn on the projector and display an image.

2 Adjust the image size using the [E-Zoom] buttons on the remote control.

After you adjust the image size, the Image Shift screen is displayed automatically.

3 Use the arrow buttons to adjust the image position.

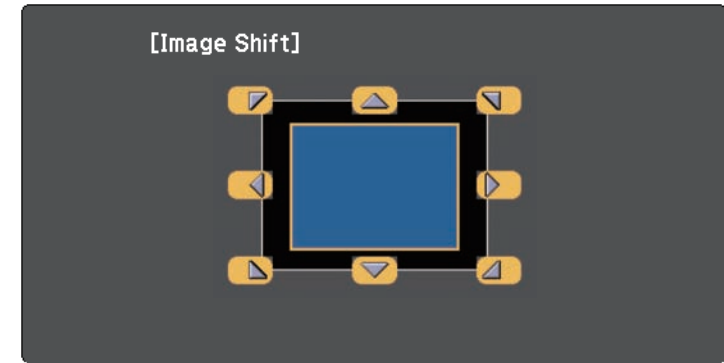

- You can shift the image diagonally by pressing any pair of adjacent arrow buttons on the remote control.

4 Press the [Esc] button to close the adjustment screen.

The adjustment screen disappears if no operation is performed after approximately 10 seconds.



- The Image Shift setting is retained even if the projector is turned off. You need to re-adjust the position if you change the installation location or angle of the projector.
- You can also use the **Settings** menu to adjust the **Image Shift** setting.

» Related Links

- "Projector Feature Settings - Settings Menu" [p.131](#)

You can correct the focus using the focus ring.

- 1** Turn on the projector and display an image.
- 2** Open the power button cover.
- 3** Rotate the focus ring to adjust the focus.

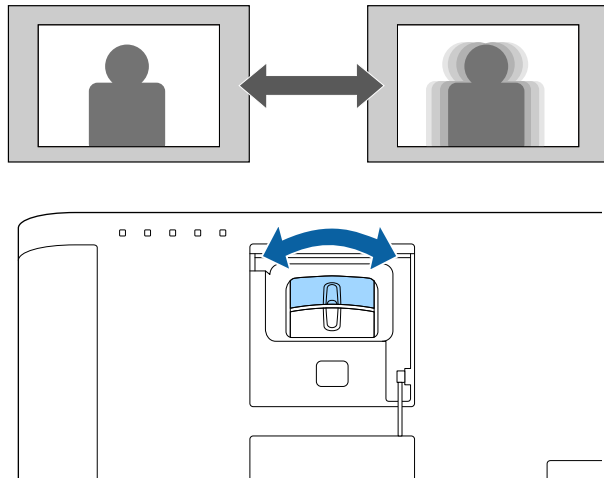

When multiple image sources are connected to the projector, such as a computer and DVD player, you can switch from one image source to the other.

- 1** Make sure the connected image source you want to use is turned on.
- 2** For video image sources, insert a DVD or other video media and press play.
- 3** Do one of the following:
 - Press the [Source Search] button on the remote control until you see the image from the source you want.

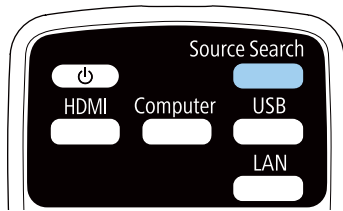

This screen is displayed when no image signal is detected. Check the cable connections between the projector and image source.

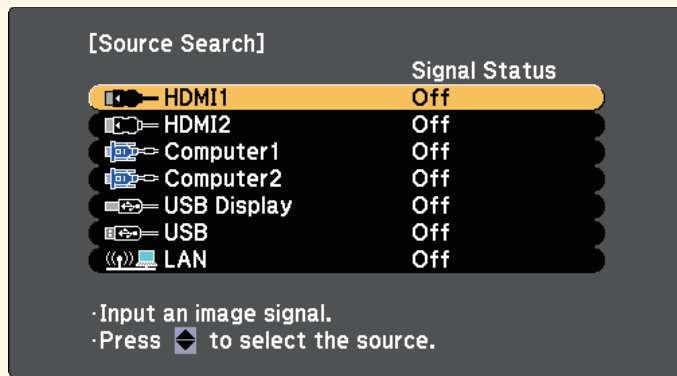

- Press the button for the source you want on the remote control. If there is more than one port for that source, press the button again to cycle through the sources.
- Press the [Home] button on the remote control.

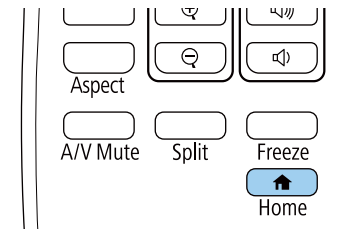

Then select the source you want to use from the screen displayed.



The projector can display images in different width-to-height ratios called aspect ratios. Normally, the input signal from your video source determines the image's aspect ratio. However, for certain images you can change the aspect ratio to fit your screen.

If you always want to use a particular aspect ratio for a certain video input source, you can select it using the projector's **Signal** menu.

► **Related Links**

- "Changing the Image Aspect Ratio" [p.49](#)
- "Available Image Aspect Ratios" [p.49](#)
- "Projected Image Appearance with Each Aspect Mode" [p.50](#)
- "Input Signal Settings - Signal Menu" [p.130](#)

Changing the Image Aspect Ratio

You can change the aspect ratio of the displayed image.

- 1 Turn on the projector and switch to the image source you want to use.
- 2 Press the [Aspect] button on the remote control.

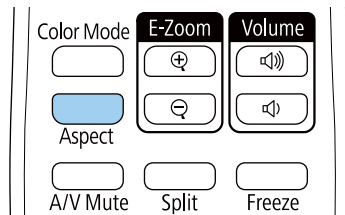

The shape and size of the displayed image changes, and the name of the aspect ratio appears briefly on the screen.

- 3 To cycle through the available aspect ratios for your input signal, press the [Aspect] button repeatedly.



To display images without black bars, set **Resolution** to **Wide** or **Normal** in the projector's **Signal** menu according to the computer's resolution.

► **Related Links**

- "Input Signal Settings - Signal Menu" [p.130](#)

Available Image Aspect Ratios

You can select the following image aspect ratios, depending on the input signal from your image source.



- The available aspect ratio setting varies depending on the input signal.
- Note that using the aspect ratio function of the projector to reduce, enlarge, or split the projected image for commercial purposes or for public viewing may infringe upon the rights of the copyright holder of that image based on copyright law.

For projectors with a resolution of WUXGA (1920 × 1200) or WXGA (1280 × 800)

| Aspect mode | Description |
|-------------|--|
| Auto | Automatically sets the aspect ratio according to the input signal and the Resolution setting. |
| Normal | Displays images using the full projection area and maintains the aspect ratio of the image. |
| 16:9 | Converts the aspect ratio of the image to 16:9. |
| Full | Displays images using the full size of the projection area, but does not maintain the aspect ratio. |
| Zoom | Displays images using the full width of the projection area and maintains the aspect ratio of the image. |
| Native | Displays images as is (aspect ratio and resolution are maintained). |

For projectors with a resolution of XGA (1024 × 768)

| Aspect mode | Description |
|-------------|--|
| Auto | Automatically sets the aspect ratio according to the input signal and the Resolution setting. |
| Normal | Displays images using the full projection area and maintains the aspect ratio of the image. |
| 4:3 | Converts the aspect ratio of the image to 4:3. |
| 16:9 | Converts the aspect ratio of the image to 16:9. |

| Aspect mode | Aspect ratio for input signals | | |
|-------------|--------------------------------|------|-----|
| | 16:10 | 16:9 | 4:3 |
| Zoom | | | |
| Native | | | |

Projected Image Appearance with Each Aspect Mode

Black bands and cropped images may project in certain aspect ratios, depending on the aspect ratio and resolution of your input signal. See the following table to confirm the position of black bands and cropped images.

 The image for **Native** varies depending on the input signal.

For projectors with a resolution of WUXGA (1920 × 1200) or WXGA (1280 × 800)

| Aspect mode | Aspect ratio for input signals | | |
|----------------|--------------------------------|------|-----|
| | 16:10 | 16:9 | 4:3 |
| Normal Auto | | | |
| 16:9 | | | |
| Full | | | |

For projectors with a resolution of XGA (1024 × 768)

| Aspect mode | Aspect ratio for input signals | | |
|----------------|--------------------------------|------|-----|
| | 16:10 | 16:9 | 4:3 |
| Normal Auto | | | |
| 4:3 | | | |
| 16:9 | | | |

The projector offers different color modes to provide optimum brightness, contrast, and color for a variety of viewing environments and image types. You can select the mode designed to match your image and environment, or experiment with the available modes.

» **Related Links**

- "Changing the Color Mode" [p.51](#)
- "Available Color Modes" [p.51](#)
- "Setting Auto Iris" [p.51](#)



You can also set the **Color Mode** setting in the projector's **Image** menu.

» **Related Links**

- "Image Quality Settings - Image Menu" [p.128](#)

Changing the Color Mode

You can change the projector's Color Mode using the remote control to optimize the image for your viewing environment.

- 1 Turn on the projector and switch to the image source you want to use.
- 2 Press the [Color Mode] button on the remote control to change the Color Mode.

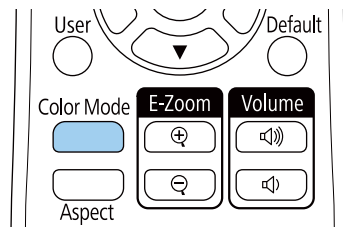

The name of the Color Mode appears briefly on the screen and then image appearance changes.

- 3 To cycle through all of the available color modes for your input signal, press the [Color Mode] button repeatedly.

Available Color Modes

You can set the projector to use these color modes, depending on the input source you are using:

| Color mode | Description |
|------------------|--|
| Dynamic | This is the brightest mode. Best for prioritizing brightness. |
| Presentation | Best for projecting vivid images. |
| Cinema | Best for enjoying content such as movies. |
| sRGB | Best for faithfully reproducing the color of the source image. |
| Blackboard | Best for projecting images directly on a green chalkboard. |
| Multi-Projection | Best for projecting from multiple projectors (reduces the color tone difference between images). |

Setting Auto Iris

You can turn on **Auto Iris** to automatically optimize the image based on the brightness of the content.

This setting is available for **Dynamic** or **Cinema** color modes.



This setting is disabled when **Edge Blending** is set to **On**.
 ➔ **Extended > Multi-Projection > Edge Blending**

- 1 Turn on the projector and switch to the image source you want to use.
- 2 Press the [Menu] button on the remote control.
- 3 Select the **Image** menu and press [Enter].

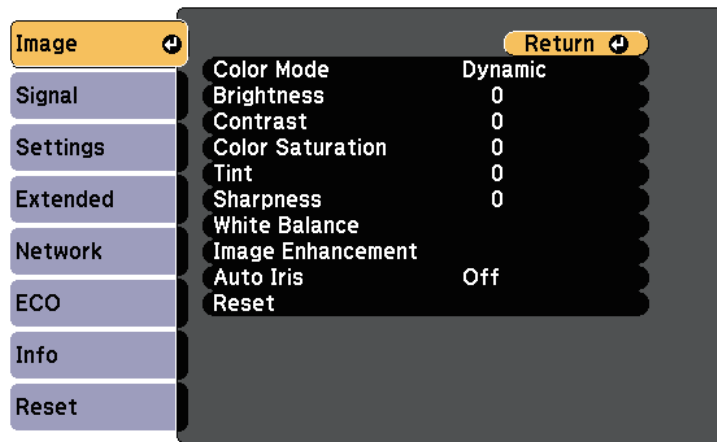

- 4 Select **Auto Iris** and press [Enter].
- 5 Choose one of the following options and press [Enter]:

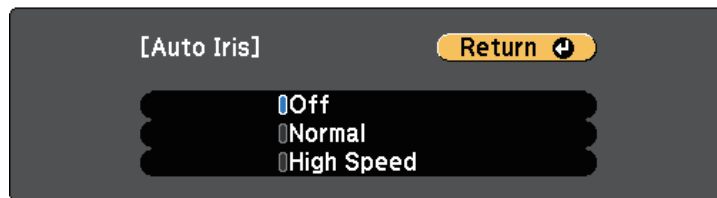

- **Normal** for standard brightness adjustment.
 - **High Speed** to adjust brightness as soon as the scene changes.
- 6 Press [Menu] or [Esc] to exit the menus.

The volume buttons control the projector's internal speaker system.

You can also control the volume of any external speakers you connected to the projector.

You must adjust the volume separately for each connected input source.

- 1** Turn on the projector and start a presentation.
- 2** To lower or raise the volume, press the [Volume] buttons on the remote control as shown.

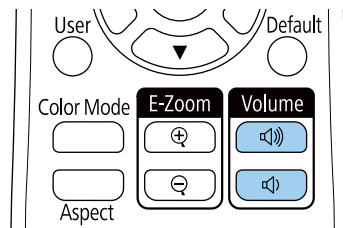

A volume gauge appears on the screen.

- 3** To set the volume to a specific level for an input source, select **Volume** in the projector's **Settings** menu.

Caution

Do not start a presentation at a high volume setting. Sudden loud noises may cause hearing loss.

Always lower the volume before powering off, so that you can power on and then gradually increase the volume.

» **Related Links**

- "Projector Feature Settings - Settings Menu" [p.131](#)

Adjusting Projector Features

Follow the instructions in these sections to use your projector's adjustment features.

► Related Links

- ["Projecting Two Images Simultaneously" p.55](#)
- ["Projecting a PC Free Presentation" p.58](#)
- ["Projecting in Content Playback Mode" p.63](#)
- ["Shutting Off the Image and Sound Temporarily" p.69](#)
- ["Stopping Video Action Temporarily" p.70](#)
- ["Saving a User's Logo Image" p.71](#)
- ["Saving a User Pattern" p.72](#)
- ["Using Multiple Projectors" p.73](#)
- ["Projector Security Features" p.81](#)

You can use the split screen feature to simultaneously project two images from different image sources. You can control the split screen feature using the remote control or the projector menus.

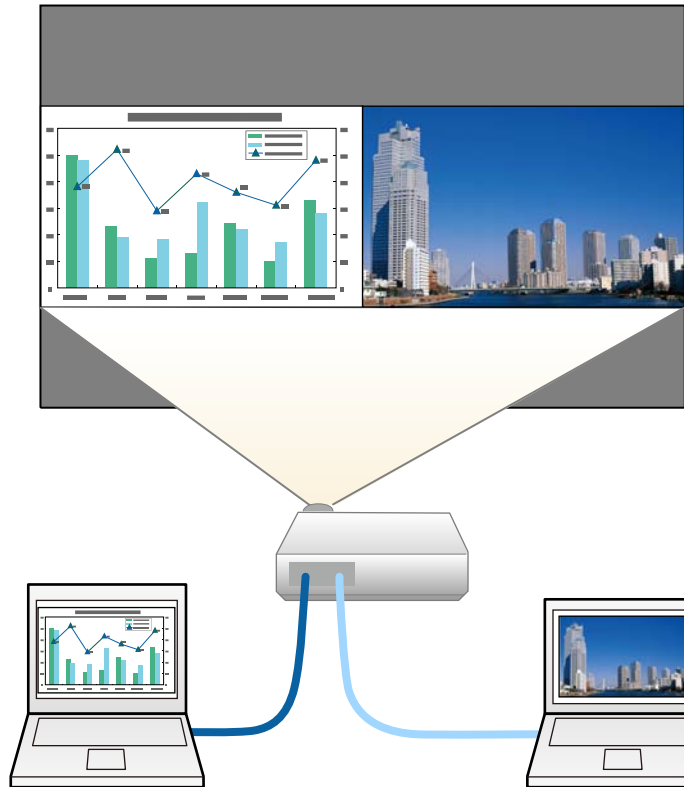

- While using the split screen feature, other projector features may not be available and some settings may be automatically applied to both images.

1 Press the [Split] button on the remote control.

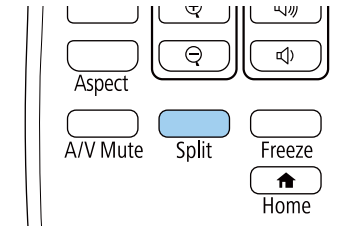

The currently selected input source moves to the left of the screen.



You can perform the same operations from **Split Screen** in the projector's **Settings** menu.

2 Press the [Menu] button.

You see this screen:

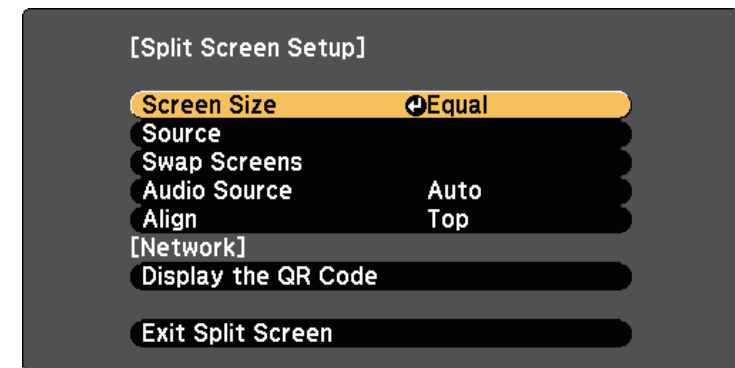

3 To select an input source for the other image, select the **Source** setting, press [Enter], select the input source, select **Execute**, and press [Enter].

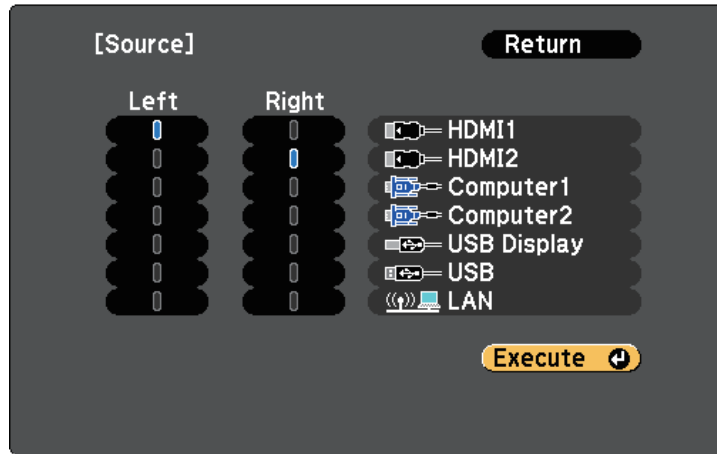

- You can only select input sources that can be combined.
- While using the split screen feature, the **Source** screen appears when you change the input source from the remote control.

4 To switch images, select **Swap Screens** and press [Enter]. The projected images on the left and right are swapped.



5 To enlarge one image while reducing the other image, select **Screen Size**, press [Enter], select a size, and press [Enter]. To exit the menu, press [Menu].



Depending on the video input signals, the images may not appear at the same size even if you select **Equal**.

6 To select the audio, select **Audio Source**, press [Enter], select an audio option, and press [Enter]. To exit the menu, press [Menu].

Select **Auto** to hear audio from the largest screen or the left screen.

7 To align the projected images, select **Align**, press [Enter], select the setting, and press [Enter] again. To exit the menu, press [Menu].

8 To exit the split screen feature, press [Split] or [Esc].

» **Related Links**

- "Unsupported Input Source Combinations for Split Screen Projection" [p.56](#)
- "Split Screen Projection Restrictions" [p.57](#)

Unsupported Input Source Combinations for Split Screen Projection

These input source combinations cannot be projected on a split screen.

- Computer1 and Computer2
 - USB Display and USB/LAN
 - USB and LAN
- "Setting Auto Iris" [p.51](#)

Split Screen Projection Restrictions

Operating restrictions

The following operations cannot be performed during split screen projection.

- Setting the projector's menu
- Switching the aspect mode (the aspect mode is set to **Normal**)
- Operations using the [User] button on the remote control
- Auto Iris

Image restrictions

- If you make adjustments such as **Brightness**, **Contrast**, **Color Saturation**, **Tint**, and **Sharpness** in the projector's **Image** menu, you can apply them only to the image on the left. Default adjustments are applied to the image on the right. Adjustments that affect the entire projected image such as **Color Mode** and **Color Temp.** are applied for both left and right images.
- Even if you make adjustments for **Noise Reduction** and **Deinterlacing** in the projector's **Image** menu, **Noise Reduction** is set to 0 and **Deinterlacing** is set to **Off** for the image on the right.
 - ☛ **Image > Image Enhancement > Noise Reduction**
 - ☛ **Image > Image Enhancement > Deinterlacing**
- Even if you set **Display Background** to **Logo** in the projector's **Extended** menu, the blue screen appears when no image signal is being input.

▶ Related Links

- "Image Aspect Ratio" [p.49](#)
- "Adjusting Image Quality (Color Mode)" [p.51](#)
- "Projector Feature Settings - Settings Menu" [p.131](#)
- "Projector Setup Settings - Extended Menu" [p.133](#)
- "Image Quality Settings - Image Menu" [p.128](#)

You can use your projector's PC Free feature whenever you connect a USB device that contains compatible presentation files. This lets you quickly and easily display a presentation and control it using the projector's remote control.

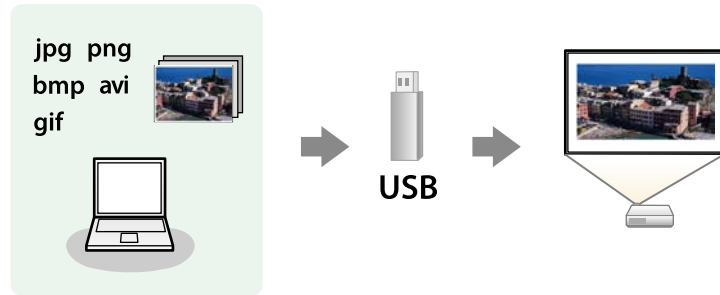

» **Related Links**

- "Supported PC Free File Types" [p.58](#)
- "Precautions on PC Free Projection" [p.58](#)
- "Starting a PC Free Slide Show" [p.59](#)
- "Starting a PC Free Movie Presentation" [p.60](#)
- "PC Free Display Options" [p.61](#)

Supported PC Free File Types

You can project these types of files using the projector's PC Free feature.



- For best results, place your files on media that is formatted in FAT16/32.
- If you have trouble projecting from media formatted for non-Windows file systems, try formatting the media for Windows instead.

| File contents | File type (extension) | Details |
|---------------|-----------------------|---|
| Image | .jpg | Make sure the file is not: <ul style="list-style-type: none"> • CMYK format • Progressive format • Highly compressed • Above 8192 × 8192 resolution |
| | .bmp | Make sure the file is not: <ul style="list-style-type: none"> • Above 1280 × 800 resolution |
| | .gif | Make sure the file is not: <ul style="list-style-type: none"> • Above 1280 × 800 resolution • Animated • Interlaced |
| | .png | Make sure the file is not: <ul style="list-style-type: none"> • Above 1280 × 800 resolution * • Interlaced |
| Movie | .avi (Motion JPEG) | Supports only AVI 1.0. Make sure the file is not: <ul style="list-style-type: none"> • Saved with an audio codec other than PCM or ADPCM • Above 1280 × 720 resolution • Larger than 2 GB |

* When you use a projector with a resolution of WUXGA, you can project a file with a maximum resolution of 1920 × 1200.

Precautions on PC Free Projection

Note the following precautions when using PC Free features.

- You cannot use a USB key for PC Free features.
- Do not disconnect the USB storage device while it is being accessed; otherwise, PC Free may not operate correctly.

- You may not be able to use the security features on certain USB storage devices with PC Free features.
- When connecting a USB device that includes an AC adapter, connect the AC adapter to an electrical outlet when you use the device with your projector.
- Some commercially available USB card readers may not be compatible with the projector.
- The projector can recognize up to 5 cards inserted into the connected card reader at one time.
- You cannot correct keystone distortion while projecting in PC Free, so correct the image shape before you begin your presentation.
- You can use the following functions while projecting in PC Free.
 - Freeze
 - A/V Mute
 - E-Zoom

▶ Related Links

- "Stopping Video Action Temporarily" [p.70](#)
- "Shutting Off the Image and Sound Temporarily" [p.69](#)

Starting a PC Free Slide Show

After connecting a USB device to the projector, you can switch to the USB input source and start your slide show.



- You can change the PC Free operation options or add special effects by highlighting **Option** at the bottom of the screen and pressing [Enter].

1 Press the [USB] button on the remote control.

The PC Free file list screen is displayed.



- If the Select Drive screen is displayed, press the arrow buttons to select the drive and press [Enter].
- To display images on the other USB drive, highlight **Select Drive** at the top of the file list screen and press [Enter].

2 Do one of the following to locate your files:

- If you need to display files inside a subfolder on your device, press the arrow buttons to highlight the folder and press [Enter].
- To move back up a folder level on your device, highlight **Back to Top** and press [Enter].

3 Do one of the following:

- To display an individual image, press the arrow buttons to highlight the image and press [Enter]. (Press the [Esc] button to return to the file list screen.)
- To display a slide show of all the images in a folder, press the arrow buttons to highlight the **Slideshow** option at the bottom of the screen and press [Enter].



- You can change the image switching time by highlighting **Option** at the bottom of the screen and pressing [Enter].
- If any file names are longer than the display area or include unsupported symbols, the file names may be shortened or changed only on the screen display.

4 While projecting, use the following commands to control the display:

- To rotate a displayed image, press the up or down arrow button.

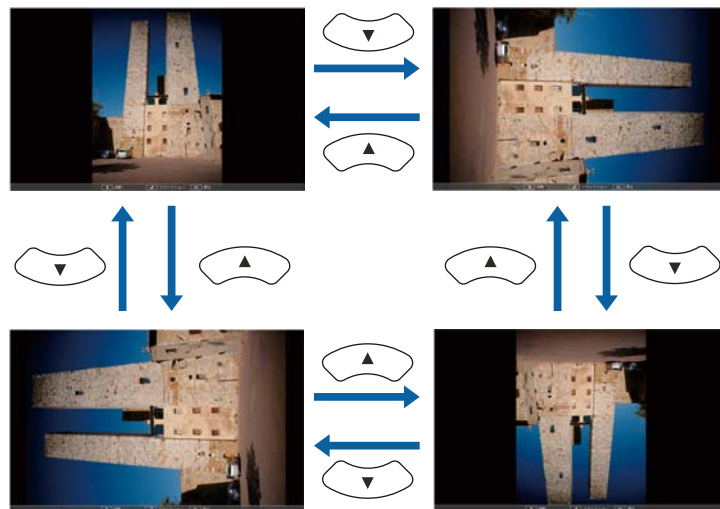

- To move to the next or previous image, press the left or right arrow button.

5 To stop the display, follow the on-screen instructions or press the [Esc] button.

You return to the file list screen.

6 Turn off the USB device, if necessary, and then disconnect the device from the projector.

» Related Links

- "PC Free Display Options" p.61
- "Connecting to a USB Device" p.24

Starting a PC Free Movie Presentation

After connecting a USB device to the projector, you can switch to the USB input source and start your movie.



- You can change the PC Free operation options by highlighting **Option** at the bottom of the screen and pressing [Enter].

1 Press the [USB] button on the remote control.

The PC Free file list screen is displayed.



- If the Select Drive screen is displayed, press the arrow buttons to select the drive and press [Enter].
- To display movie files on the other USB drive, highlight **Select Drive** at the top of the file list screen and press [Enter].

- 2** Do one of the following to locate your files:
- If you need to display files inside a subfolder on your device, press the arrow buttons to highlight the folder and press [Enter].
 - To move back up a folder level on your device, highlight **Back to Top** and press [Enter].

- 3** To play back a movie, press the arrow buttons to highlight the file and press [Enter].



- If any file names are longer than the display area or include unsupported symbols, the file names may be shortened or changed only on the screen display.
- If you want to play back all the movies in a folder in sequence, select the **Slideshow** option at the bottom of the screen.

- 4** To stop movie playback, press the [Esc] button, highlight **Exit**, and press [Enter].

You return to the file list screen.

- 5** Turn off the USB device, if necessary, and then disconnect the device from the projector.

» **Related Links**

- "PC Free Display Options" [p.61](#)
- "Connecting to a USB Device" [p.24](#)

PC Free Display Options

You can select these display options when using PC Free. To access this screen, highlight **Option** at the bottom of the PC Free file list screen and press [Enter].



| Setting | Options | Description |
|-----------------------|------------------------|---|
| Display Order | Name Order | Displays files in name order |
| | Date Order | Displays files in date order |
| Sort Order | In Ascending | Sorts files in first-to-last order |
| | In Descending | Sorts files in last-to-first order |
| Continuous Play | On | Displays a slide show continuously |
| | Off | Displays a slide show once |
| Screen Switching Time | No | Does not display the next file automatically |
| | 1 Second to 60 Seconds | Displays files for the selected time and switches to the next file automatically; high resolution images may switch at a slightly slower rate |

| Setting | Options | Description |
|---------|----------|--|
| Effect | No | No effect |
| | Wipe | Transitions between images using a wipe effect |
| | Dissolve | Transitions between images using a dissolve effect |
| | Random | Transitions between images using a random variety of effects |

Your projector's Content Playback feature allows you to project your content for exhibitions as digital signage. You can easily project playlists that contain images and movies saved on an external storage device. You can also add color and shape effects to your projected image.



» Related Links

- "Switching to Content Playback Mode" [p.63](#)
- "Using Spotlight Mode" [p.64](#)
- "Projecting Your Playlists" [p.65](#)
- "Projecting One Image Simultaneously (Synchronized Playback)" [p.65](#)
- "Adding Effects to Your Projected Image" [p.66](#)
- "Content Playback Mode Restrictions" [p.67](#)

Switching to Content Playback Mode

Before you project your playlists, you need to switch to Content Playback mode.

- 1 Turn on the projector.
- 2 Press the [Menu] button, select the **Settings** menu, and then press [Enter].

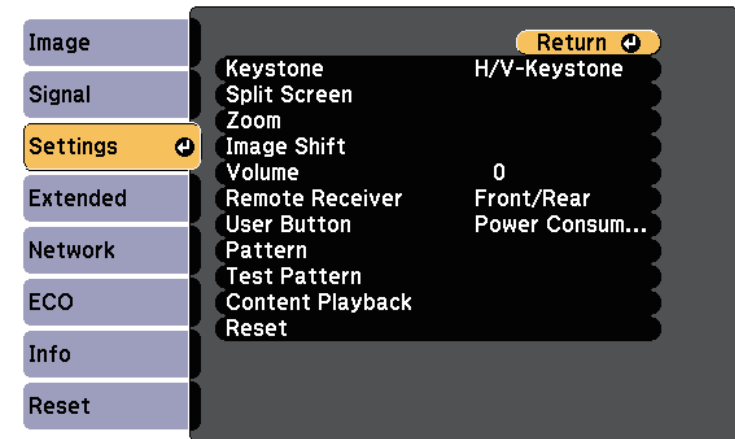

- 3 Select **Content Playback** and press [Enter].
- 4 Select **On** and press [Enter].

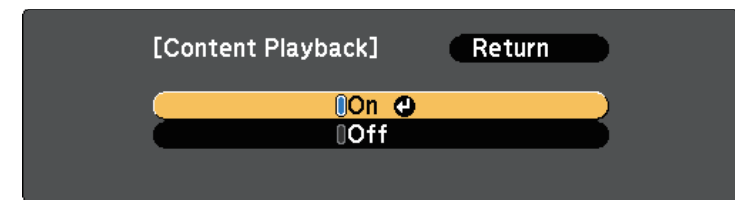

You see a confirmation prompt.

- 5 Turn off the projector, then turn it on again to enable Content Playback mode.
- 6 Press the [Home] button on the remote control.

The Home screen is displayed.

- 7 Make sure the projector is in Content Playback mode.



Using Spotlight Mode

In Content Playback mode, you can use spotlight mode to project a virtual spotlight and customize the position, size, shape and width of the light.

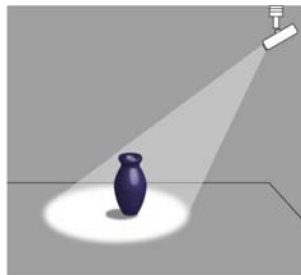

- 1 Press the [Home] button on the remote control.

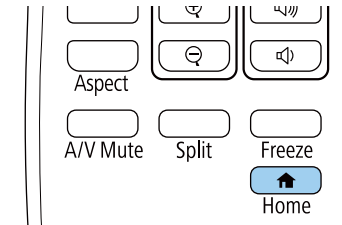

The Home screen is displayed.

- 2 Select **Spotlight** from **Useful Functions** on the Home screen.
The projected image becomes a spotlight.



- When **Spotlight** is not displayed on the Home screen, select **Spotlight** as the **Custom Function 1** or **Custom Function 2** setting in the **Home Screen** menu.
 - ☛ **Extended > Home Screen**
- You can assign the Spotlight function to the [User] button on the remote control using the **User Button** menu.
 - ☛ **Settings > User Button**

- 3 Press the [Effect] button on the remote control to change the overlay effect and shape filter for the spotlight.

» Related Links

- "Adding Effects to Your Projected Image" [p.66](#)

Projecting Your Playlists

You can project playlists that contain images and movies in Content Playback mode.

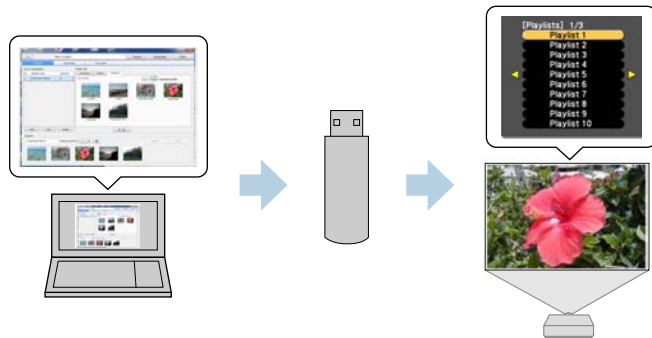

The playlist that was played last is projected. If there is a timetable assigned, the playlist will play back according to the schedule in the timetable.



- You can also hold down the [Num] and numeric buttons to project the favorite playlist. You can set a remote control shortcut key using the Epson Projector Content Manager software.
- To select the target playlist from the list, press the [USB Viewer] button on the remote control, and then use the arrow buttons.

Projecting One Image Simultaneously (Synchronized Playback)

You can set up a timetable to simultaneously project a synchronized playlist across multiple (up to 16) projectors.

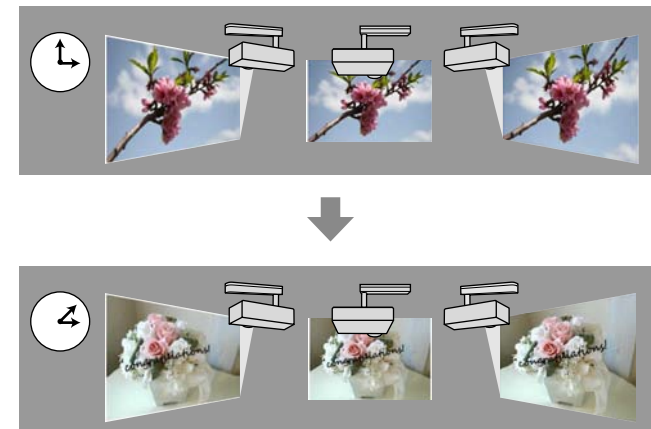

- 1** Create your playlists and export them to a USB flash drive using the Epson Projector Content Manager software.



See the *Epson Projector Content Manager Operation Guide* for instructions.

- 2** In Content Playback mode, connect the USB flash drive into the projector's USB-A port.

- 3** Press the [USB] button on the remote control.

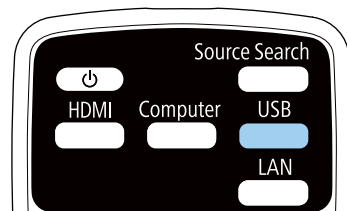



- All projectors that will be involved in synchronized playback must be the same model. If any of the projectors are a different model or have a different resolution, synchronized playback may not be performed properly.
- Make sure the name, date, and time settings are correct for all projectors.
- Connect all projectors to the same network. We recommend connecting over a wired LAN. Otherwise, playback may not be performed simultaneously between projectors depending on the network status.

- 1** Create playlists, set timetables for each of the playlists, and export them to USB flash drives using the Epson Projector Content Manager software.



- See the *Epson Projector Content Manager Operation Guide* for instructions.
- Make sure you prepare the same number of USB flash drives as there are projectors.
- If you want to include still images in the playlists, prepare them in JPEG format.

- 2** In Content Playback mode, connect a USB flash drive containing the playlists to each projector's USB-A port.

- 3** Press the [USB] button on the remote control.

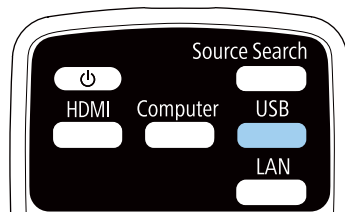

Synchronized playback starts at the time specified in the playlist timetables.

» Related Links

- "Wired Network Projection" [p.86](#)
- "Network Menu - Basic Menu" [p.137](#)
- "Setting the Date and Time" [p.35](#)

Adding Effects to Your Projected Image

You can add color and shape effects to the projected image in Content Playback mode.



To use the effect functions, make sure you perform **Refresh Mode** regularly.

➡ **Reset > Refresh Mode**

- 1 In Content Playback mode, press the [Menu] button, select the **Settings** menu, and then press [Enter].

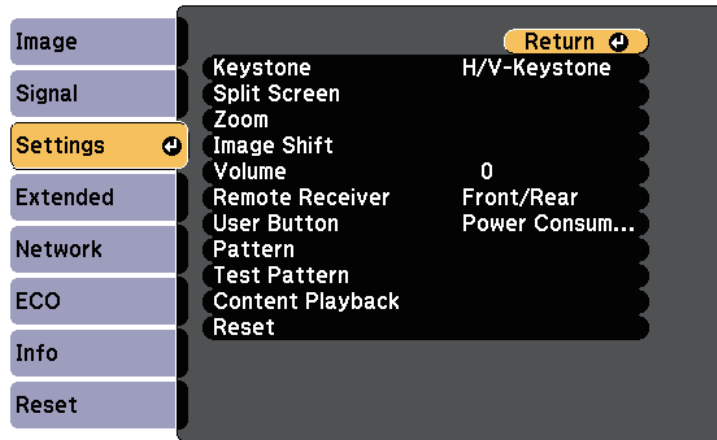

- 2 Select **Content Playback > Overlay Effect**, and press [Enter].
- 3 Select **On** as the **Overlay Effect** setting and press [Enter].

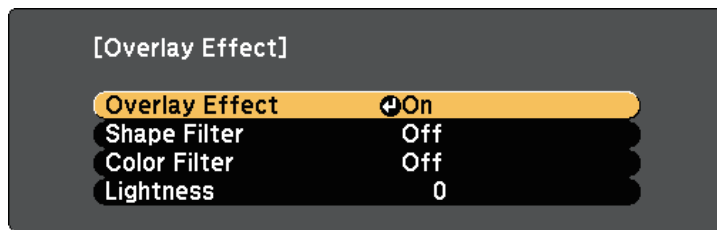

- 4 Select **Shape Filter** and press [Enter].
- 5 Adjust each of the following options as necessary:
 - **Shape** to select the shape effect you want from circles, rectangles, or customized shapes.



You can add your images as customized shapes using the Epson Projector Content Manager software. See the *Epson Projector Content Manager Operation Guide* for details.

- **Filter Effect** to select whether to mask inside or outside of the selected shape.
- **Size** to set the shape size.
- **Position** to set the shape position.

- 6 Select **Color Filter** and press [Enter].
- 7 Adjust each of the following options as necessary:
 - **Color Filter** to select the color.
 - **Custom** to set a customized color by adjusting **Red**, **Green**, and **Blue** individually.
- 8 Select **Lightness** to set the brightness level.
- 9 When you are finished, press [Menu] to exit the menus.

Content Playback Mode Restrictions

Operating restrictions

You cannot perform the following operations in Content Playback mode.

- Color Temp. (when **Warm White** or **Cool White** is selected as **Color Filter**)
- Split Screen
- Display Background
- Auto Source Search
- Remote Password
- PC Free

- Document camera

You can temporarily turn off the projected image and sound if you want to redirect your audience's attention during a presentation. Any sound or video action continues to run, however, so you cannot resume projection at the point that you stopped it.

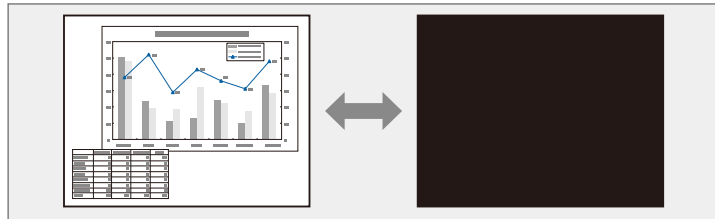

» Related Links

- "Projector Setup Settings - Extended Menu" [p.133](#)
- "Projector Setup Settings - ECO Menu" [p.144](#)



If you want to display an image such as a company logo or picture when the [A/V Mute] button is pressed, you can select the screen displayed in the **A/V Mute** setting in the projector's **Extended** menu.

☛ **Extended > Display > A/V Mute**

- 1** Press the [A/V Mute] button on the remote control to temporarily stop projection and mute any sound.

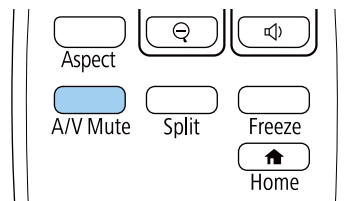

- 2** To turn the image and sound back on, press [A/V Mute] again.



- The projector's power automatically turns off 30 minutes after A/V Mute is enabled. You can disable this feature.

☛ **ECO > A/V Mute Timer**

- The lamp is still operating during A/V Mute, so the lamp hours continue to accumulate.

You can temporarily stop the action in a video or computer presentation and keep the current image on the screen. Any sound or video action continues to run, however, so you cannot resume projection at the point that you stopped it.

- 1** Press the [Freeze] button on the remote control to stop the video action.

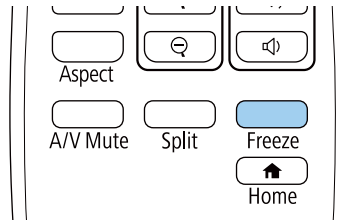

- 2** To restart the video action in progress, press [Freeze] again.

You can save an image on the projector and display it whenever the projector turns on. You can also display the image when the projector is not receiving an input signal. This image is called the user's logo screen.

You can select a photo, graphic, or company logo as the user's logo, which is useful in identifying the projector's owner to help deter theft. You can prevent changes to the user's logo by setting up password protection.



- If the **User's Logo Protection** setting is set to **On** in the **Password Protection** setting menu, set to **Off** before saving the user's logo.
- When you copy the menu settings from one projector to another using the batch setup feature, user's logo is also copied. Do not register the information that you do not want to share between multiple projectors as a user's logo.

- 1 Display the image you want to project as the user's logo.
- 2 Press the [Menu] button, select the **Extended** menu, and press [Enter].

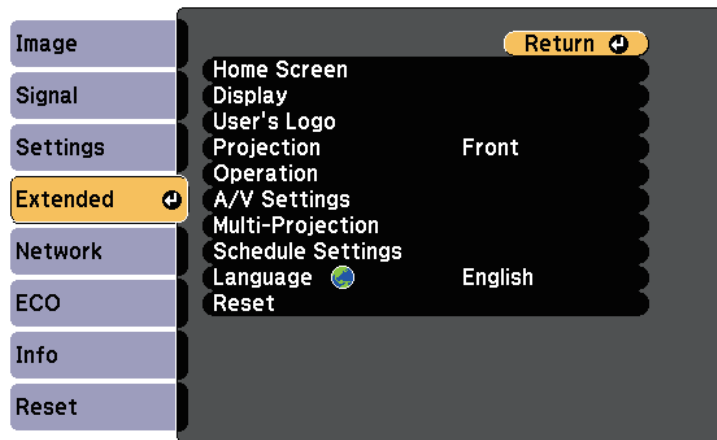

- 3 Select **User's Logo > Start Setting** and press [Enter].
You see a prompt asking if you want to use the displayed image as a user's logo.



Adjustments such as Keystone, E-Zoom, Aspect, or Scale are temporarily canceled when you select **User's Logo**.

- 4 Select **Yes** and press [Enter].
- 5 Check the displayed image, and then select **Yes** to save it as the user's logo.
The user's logo is overwritten and a completion message is displayed.
- 6 Press [Esc] to exit the message screen.
- 7 Select the **Extended** menu and press [Enter].
- 8 Select **Display** and press [Enter].
- 9 Select when you want to display the User's Logo screen:
 - To display it whenever there is no input signal, select **Display Background** and set it to **Logo**.
 ➤ **Extended > Display > Display Background**
 - To display it whenever you turn the projector on, select **Startup Screen** and set it to **On**.
 ➤ **Extended > Display > Startup Screen**
 - To display it whenever you press the [A/V Mute] button, select **A/V Mute** and set it to **Logo**.
 ➤ **Extended > Display > A/V Mute**

To prevent anyone from changing the User's Logo settings without first entering a password, set the **User's Logo Protection** setting to **On** in the **Password Protection** setting menu and set the password.

» Related Links

- "Shutting Off the Image and Sound Temporarily" [p.69](#)
- "Selecting Password Security Types" [p.82](#)

There are four types of patterns pre-registered in the projector, such as ruled lines and grid patterns. You can project these patterns to aid in presentations using the **Pattern Display** settings in the **Settings** menu.

You can also save the image that is currently being projected as a User Pattern.



Once you save a User Pattern, the pattern cannot be returned to the factory default.

- 1 Project the image you want to save as the User Pattern.
- 2 Press the [Menu] button on the remote control, select the **Settings** menu, and press [Enter].

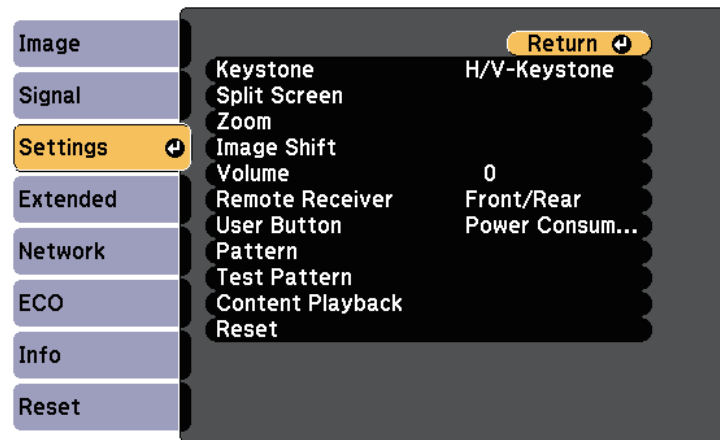

- 3 Select **Pattern > User Pattern** and press [Enter].
You see a prompt asking if you want to use the displayed image as a User Pattern.



Adjustments such as Keystone, E-Zoom, or Aspect are temporarily cancelled when you select **User Pattern**.

- 4 Select **Yes** and press [Enter].
You see a prompt asking if you want to save the image as the User Pattern.
- 5 Select **Yes** and press [Enter].
You see a completion message.

You can combine the projected images from two or more projectors to create one large image.

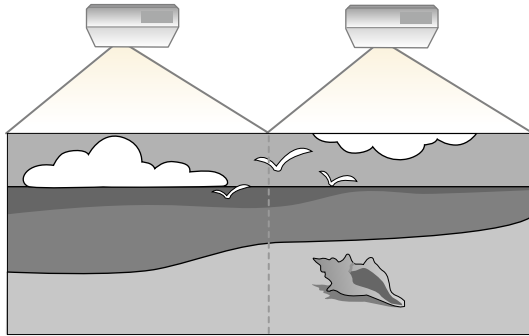

- Before starting projection, make sure you select **Multi-Projection** as the **Color Mode** setting for all of the projectors.
☛ **Extended > Multi-Projection > Color Mode**

» Related Links

- "Projector Identification System for Multiple Projector Control" [p.73](#)
- "Adjusting Color Uniformity" [p.75](#)
- "Blending the Image Edges" [p.76](#)
- "Scaling an Image" [p.77](#)
- "Adjusting the Projector's Brightness Level" [p.78](#)
- "Matching the Image Colors" [p.79](#)

Projector Identification System for Multiple Projector Control

When lining up multiple projectors to project images, you can correct the brightness and color tone of each projector's image so that the images match closely.

You can set a unique projector ID for each projector to operate them individually using a remote control, and then correct the brightness and color for each projector.



- In some cases the brightness and color tone may not match completely even after correction.
- If brightness and color tone differences become more noticeable over time, repeat the adjustments.

» Related Links

- "Setting the Projector ID" [p.73](#)
- "Selecting the Projector You want to Operate" [p.74](#)

Setting the Projector ID

To control multiple projectors from a remote control, give each projector a unique ID.

- 1** Press the [Menu] button, select the **Extended** menu, and press [Enter].
- 2** Select **Multi-Projection** and press [Enter].
- 3** Select **Projector ID** and press [Enter].

- Use the arrow buttons to select the identification number you want to use for the projector. Then press [Enter].

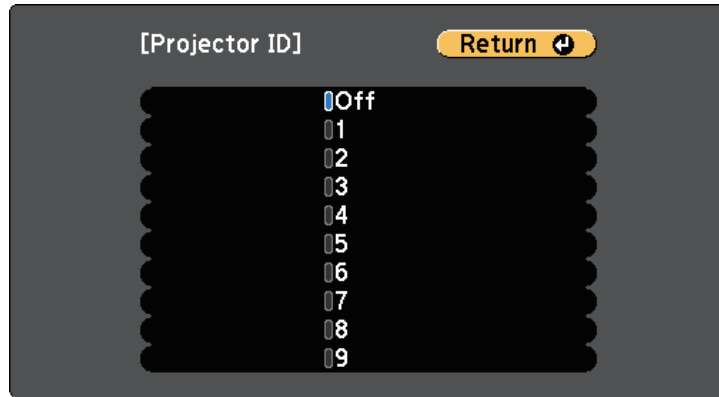

- Press [Menu] or [Esc] to exit the menus.
- Repeat these steps for all the other projectors you want to operate from one remote control.

Selecting the Projector You want to Operate

After setting the projector's ID, select the ID for the projector you want to operate using the remote control.

- Aim the remote control at the target projector and press the [ID] button.

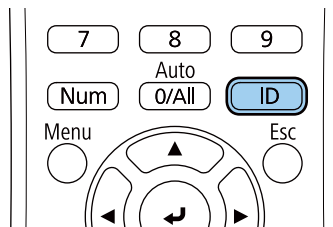

The current Projector ID is displayed on the projected screen. It disappears after about 3 seconds.

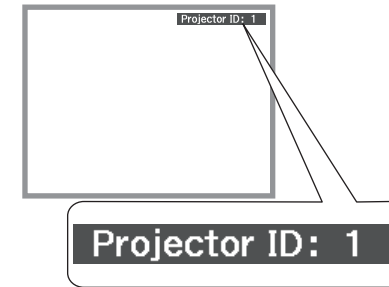

- While holding the [ID] button, press the number button that matches the ID of the projector you want to operate.

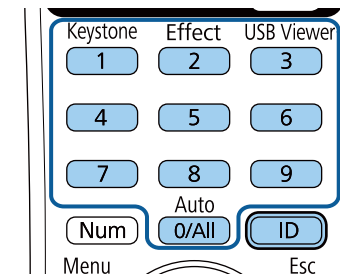

The projector you want to operate is selected.



- When you select [0/All] on the remote control, you can operate all projectors regardless the **Projector ID** setting.
- When you set the **Projector ID** setting to **Off**, you can operate the projector using the remote control whichever ID you select on the remote control.
- The projector ID setting is saved in the remote control. Even if the remote control batteries are removed to replace them and so on, the saved ID setting is retained. However, if the batteries are left out of the remote control for an extended period, the ID returns to its default setting (0/All).

Adjusting Color Uniformity

If the color tone on the projected screen is uneven in each projector, adjust the color tone balance using each projector's **Extended** menu.



- The color tone may not be uniform even after performing color uniformity.
- When the Color Mode is set to **Dynamic**, this function is disabled.
Image > Color Mode

1 Press the [Menu] button, select the **Extended** menu, and press [Enter].

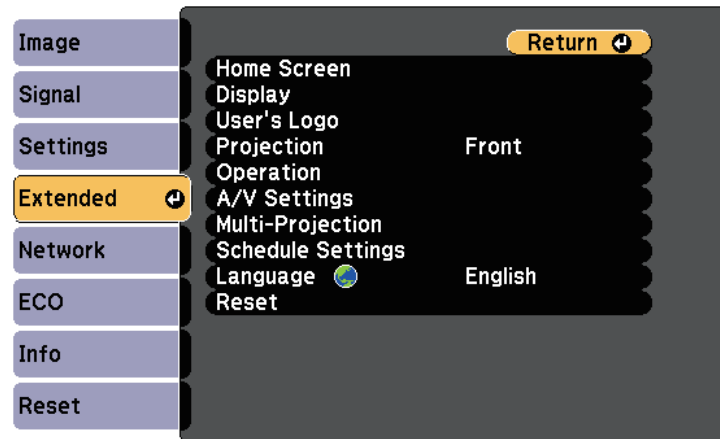

2 Select **Multi-Projection** and press [Enter].

3 Select **Color Uniformity** and press [Enter].

4 Select **Color Uniformity** and press [Enter].

5 Select **On** and press [Enter]. Then press [Esc].

6 Select **Adjustment Level** and press [Enter].

7 Select the level and press [Esc].

There are eight adjustment levels from white through gray, and up to black. You can adjust each level individually.



8 Select **Start Adjustments** and press [Enter].

9 Select the area you want to adjust, and press [Enter].

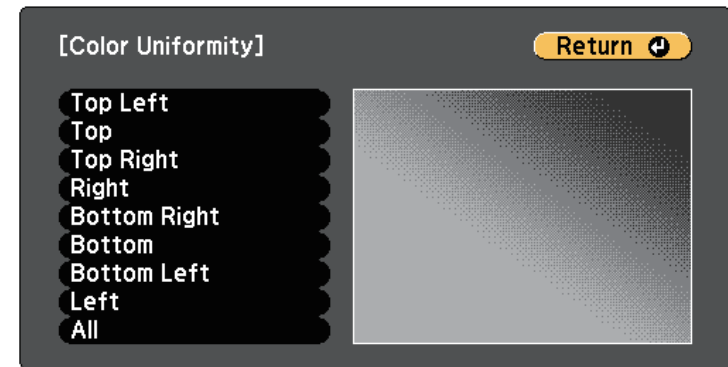

Adjust the circumference first. Finally select **All**, and then adjust the whole screen.

10 Select the color (**Red**, **Green**, or **Blue**) you want to adjust, and use the left arrow button to weaken the color tone and the right arrow button to strengthen the color tone.



The adjustment screen changes each time you press [Enter].

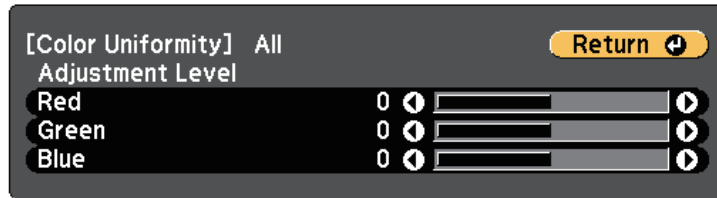

- 11** Press [Esc] to return to the area selection screen.
- 12** Repeat these steps to adjust each area.
- 13** Return to step 6 and adjust other levels.
- 14** Press [Esc] to return to the previous screen.

Blending the Image Edges

You can use the projector's **Edge Blending** feature to create a seamless image from multiple projectors.

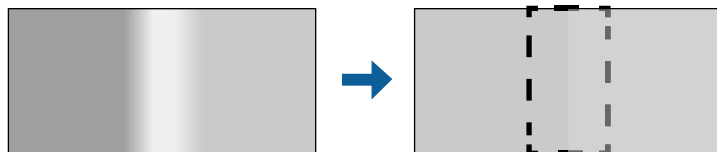

- 1** Press the [Menu] button, select the **Extended** menu, and press [Enter].

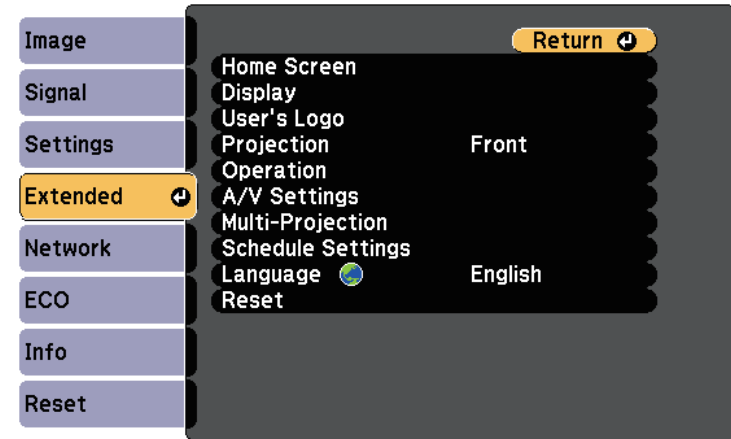

- 2** Select **Multi-Projection > Edge Blending**, and press [Enter].
- 3** Turn on the **Edge Blending**, **Line Guide**, and **Pattern Guide** settings.
- 4** Select the edge you want to blend on each projector and press [Enter].
You see a screen like this:



- 5** Select the **Blending** setting and select **On**.

- 6 Select the **Blend Range** setting and use the arrow buttons to select the width of the blended area so that the displayed guides are at the edges of the overlapping area between the two images.

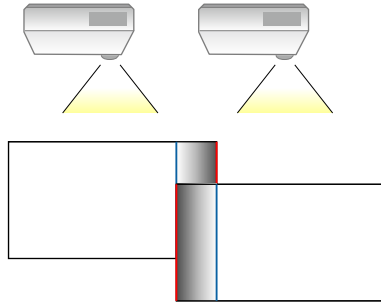

- 7 Press [Esc] to go back to the previous screen.
- 8 Select the **Blend Curve** setting and select a gradient for the shaded area on the projectors.
- 9 When the edges are blended, turn off the **Line Guide** and **Pattern Guide** settings on each projector to check the final settings.
- 10 When you are finished, press the [Menu] button.

Scaling an Image

You can project the same image from multiple projectors and use the **Scale** feature to crop and combine them into one large image.

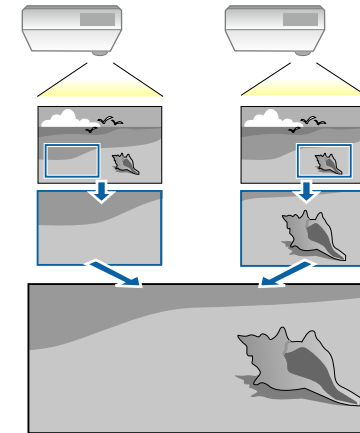

- 1 Press the [Menu] button, select the **Extended** menu, and press [Enter].

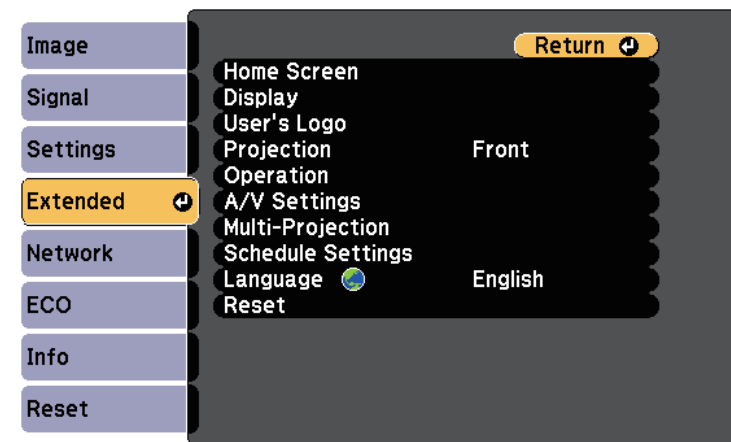

- 2 Select **Multi-Projection > Scale**, and press [Enter].

You see this screen:

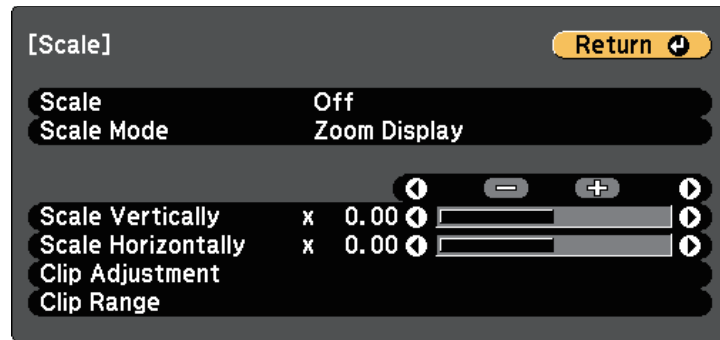

3 Select **On** as the **Scale** setting.

4 Select the **Scale Mode** setting and select one of these options:

- **Zoom Display** to maintain the image aspect ratio as you scale the image.

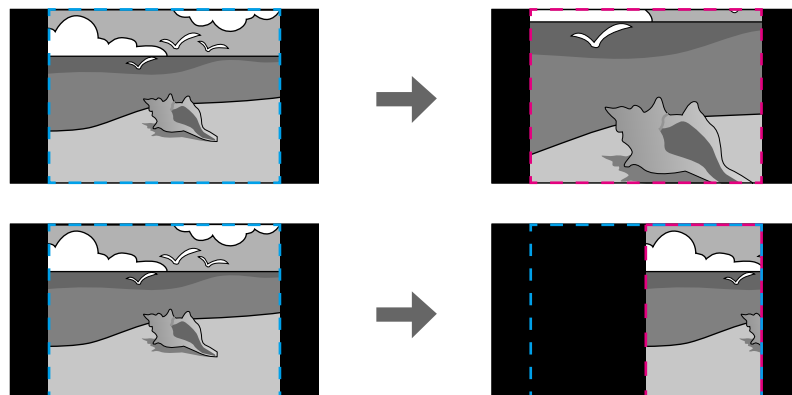

- **Full Display** to adjust the image to the projector's screen size as you scale the image.

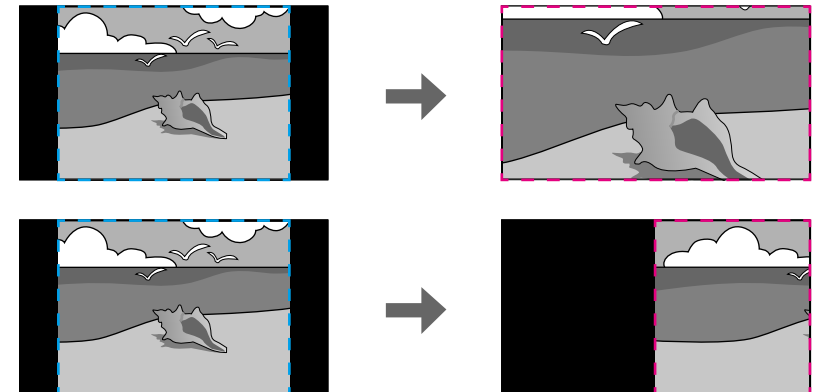

5 Select one or more of the following scaling options and adjust it as necessary:

- - or + to scale the image horizontally and vertically at the same time.
- **Scale Vertically** to scale the image vertically only.
- **Scale Horizontally** to scale the image horizontally only.

6 Select the **Clip Adjustment** setting and use the arrow buttons to adjust the coordinates and size of each image as you view the screen.

7 Select **Clip Range** to preview the clipped area you selected.

8 When you are finished, press [Menu].

Adjusting the Projector's Brightness Level

When projecting with multiple projectors, you must adjust the brightness setting so that all projectors are equally bright. (Even after adjusting the brightness levels, the brightness of each projector may not match exactly.)

- 1 Turn on all the projectors and display the same image.
- 2 Press the [Menu] button, select the **Extended** menu, and press [Enter].

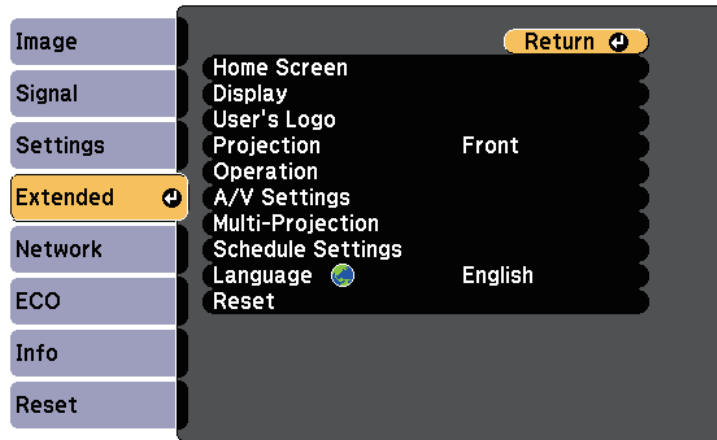

- 3 Select **Multi-Projection > Power Consumption**, and press [Enter].
- 4 Select the brightness setting of the projector lamp.

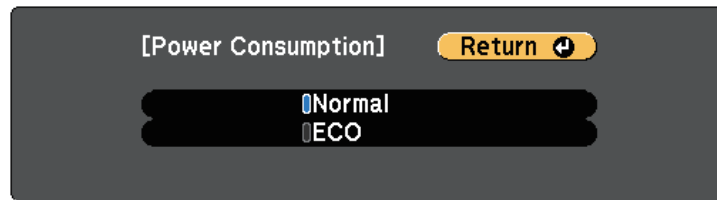

- **Normal:** Sets maximum lamp brightness.
- **ECO:** Reduces lamp brightness and fan noise, and saves power and lamp life.

- 5 When you are finished, press [Menu].

Matching the Image Colors

You can match the display quality of multiple projectors that will project next to each other.

Turn on all the projectors and select the **Color Matching** setting in each projector's **Extended** menu so that all the projectors' display quality match on the combined screen.

- 1 Press the [Menu] button, select the **Extended** menu, and press [Enter].

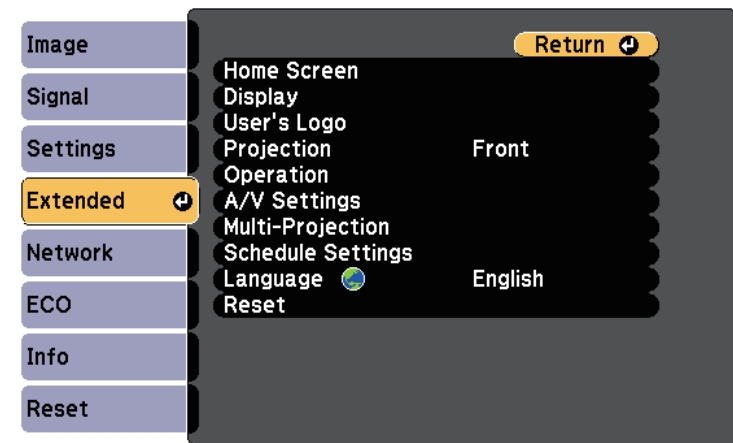

- 2 Select **Multi-Projection** and press [Enter].
- 3 Select **Color Matching** and press [Enter].
- 4 Select **Adjustment Level**.

There are eight adjustment levels from white through gray, and up to black. You can adjust each level individually.



- 5** Select **Red**, **Green**, or **Blue**, and adjust the color tone.
- 6** Select **Brightness**, and adjust the value.
- 7** Return to step 4 and adjust other levels.
- 8** Press [Esc] to return to the previous screen.

You can secure your projector to deter theft or prevent unintended use by setting up the following security features:

- Password security to prevent people who do not know the password from using the projector, and prevent changes to the startup screen and other settings.
This acts as an anti-theft function as the projector cannot be used even if it is stolen, and you can limit who can use the projector.
- Security cabling to physically secure the projector in place.

» Related Links

- "Password Security Types" [p.81](#)
- "Installing a Security Cable" [p.83](#)

Password Security Types

You can set up the following types of password security using one shared password:

- **Power On Protection** password prevents anyone from using the projector without first entering a password. When plugging the power cord and turning on the projector at first time, you must enter the correct password. This also applies to **Direct Power On** and **Auto Power On**.
- **User's Logo Protection** password prevents anyone from changing the custom screen displayed when the projector turns on, when no signal is being input, or when you use the A/V Mute feature. The custom screen discourages theft by identifying the projector's owner.
- **Network Protection** password prevents anyone from changing the projector's **Network** settings.
- **Schedule Protection** password prevents anyone from changing the projector's schedule settings.

» Related Links

- "Setting a Password" [p.81](#)
- "Selecting Password Security Types" [p.82](#)
- "Entering a Password to Use the Projector" [p.83](#)

Setting a Password

To use password security, you must set a password.



The default password is set to "0000". Change this to your own password.

1

Hold down the [Freeze] button on the remote control for about 5 seconds.

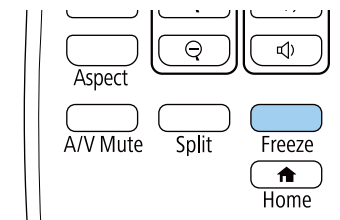

You see the Password Protection setting menu.



If Password Protection is already activated, you must enter the correct password to display the Password Protection setting menu.

2

Select **Password** and press [Enter].

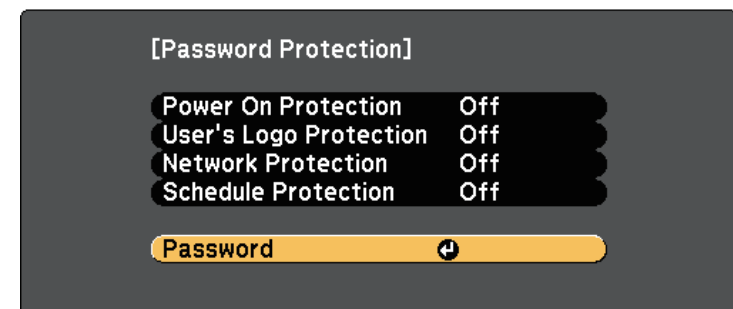

You see the prompt "Change the password?".

- 3 Select **Yes** and press [Enter].



If you select **No**, the Password Protection setting menu is displayed again.

- 4 Hold down the [Num] button on the remote control and use the numeric buttons to set a four-digit password.

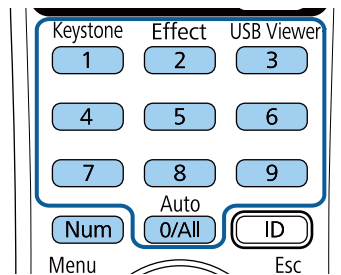

The password displays as **** as it is entered. A confirmation prompt is displayed when you enter the fourth digit.

- 5 Enter the password again.

You see the message "Password accepted". If you enter the password incorrectly, a message is displayed prompting you to re-enter the password.

- 6 Press [Esc] to return to the menu.

- 7 Make a note of the password and keep it in a safe place.

Selecting Password Security Types

After setting a password, you see this menu, allowing you to select the password security types you want to use.

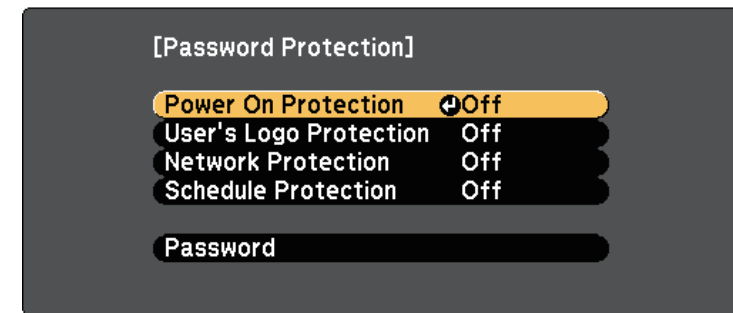

If you do not see this menu, hold down the [Freeze] button on the remote control for 5 seconds until the menu appears.

- To prevent unauthorized use of the projector, select **On** as the **Power On Protection** setting.
- To prevent changes to the User's Logo screen or related display settings, select **On** as the **User's Logo Protection** setting.
- To prevent changes to network settings, select **On** as the **Network Protection** setting.
- To prevent changes to the projector's schedule settings, select **On** as the **Schedule Protection** setting.

You can attach the password protect sticker to the projector as an additional theft deterrent.



Be sure to keep the remote control in a safe place; if you lose it, you will not be able to enter the password.

Entering a Password to Use the Projector

When the password screen is displayed, enter the correct password.

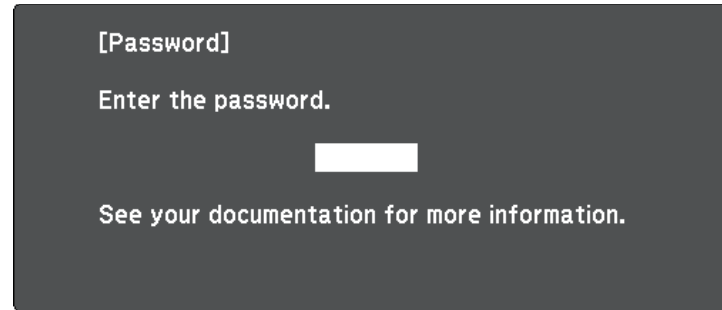

Attention

- If an incorrect password is entered three times in succession, the message "The projector's operation will be locked." is displayed for approximately 5 minutes, and the projector switches to standby mode. If this happens, disconnect the power plug from the electrical outlet, reinsert it, and turn the projector back on. The projector displays the password entry screen again so that you can enter the correct password.
- If you have forgotten the password, make a note of the "Request Code: xxxxx" number that appears on the screen and contact Epson for help.
- If you continue to repeat the above operation and input the wrong password 30 times in succession, the message "The projector's operation will be locked. Contact Epson as described in your documentation." is displayed and the projector does not accept any more password entries. Contact Epson for help.

- 1 Hold down the [Num] button on the remote control while you enter the password using the numeric buttons.

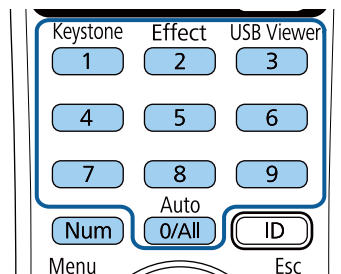

The password screen closes.

- 2 If the password is incorrect, you see a message and a prompt to try again. Enter the correct password to proceed.

Installing a Security Cable

You can install the security cable on the projector to deter theft.

- Use the security slot on the projector to attach a Kensington Microsaver Security system.



For more details on the Microsaver Security System, visit the Kensington Web site.

<http://www.kensington.com/>

- Use the security cable attachment point on the projector to attach a wire cable and secure it to a room fixture or heavy furniture.

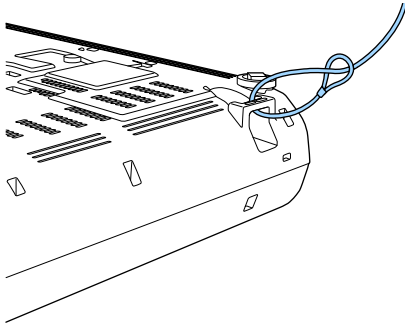

You can use a commercially available theft-prevention wire lock. See the documentation supplied with the wire lock for locking instructions.

Using the Projector on a Network

Follow the instructions in these sections to set up your projector for use on a network.

► **Related Links**

- "Wired Network Projection" [p.86](#)
- "Wireless Network Projection" [p.89](#)
- "Secure HTTP" [p.97](#)

You can send images to your projector through a wired network. To do this, connect the projector to your network, and then set up your projector and computer for network projection.

After connecting and setting up the projector as described here, download and install Epson iProjection (Windows/Mac) from the following Web site.

<http://www.epson.com/>

Epson iProjection software sets up your computer for network projection. It also allows you to hold interactive meetings by projecting user's computer screens over a network. See the *Epson iProjection Operation Guide (Windows/Mac)* for instructions.

► Related Links

- "Connecting to a Wired Network" p.86
- "Selecting Wired Network Settings" p.86

Connecting to a Wired Network

To connect the projector to a wired local area network (LAN), use a 100Base-TX or 10Base-T network cable. To ensure proper data transmission, use a Category 5 shielded cable or better.

- 1 Connect one end of the network cable to your network hub, switch, or router.
- 2 Connect the other end of the cable to the projector's LAN port.

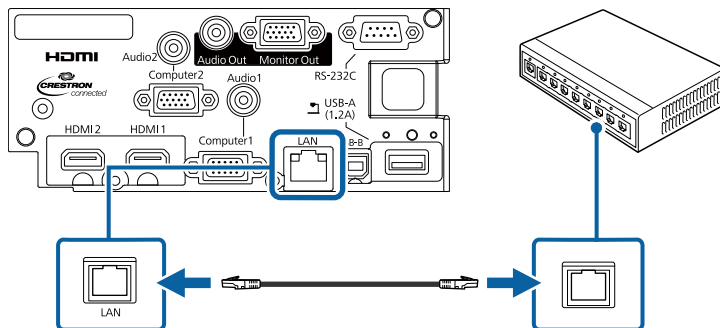

Selecting Wired Network Settings

Before you can project from computers on your network, you need to select network settings on the projector.



Make sure you already connected the projector to your wired network using the LAN port.

- 1 Press the [Menu] button, select the **Network** menu, and press [Enter].

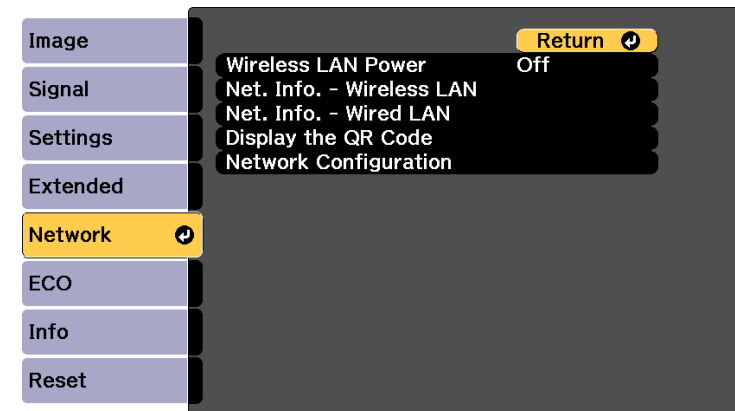

- 2 Select **Network Configuration** and press [Enter].

3 Select the **Basic** menu and press [Enter].

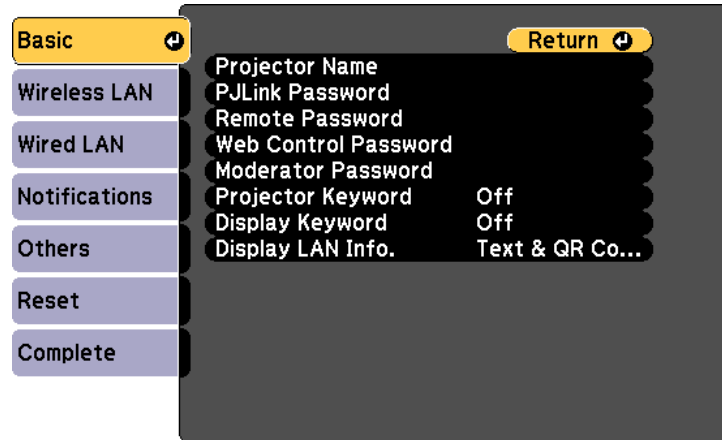

4 Select the basic options as necessary.

- **Projector Name** lets you enter a name up to 16 alphanumeric characters long to identify the projector over the network.
- **PjLink Password** lets you enter a password up to 32 alphanumeric characters long for using the PjLink protocol for projector control.
- **Remote Password** lets you enter a password up to 8 alphanumeric characters long for accessing the projector using the Basic Control. (User name is **EPSONREMOTE**; default password is **guest**.)
- **Web Control Password** lets you enter a password up to 8 alphanumeric characters long for accessing the projector over the Web. (User name is **EPSONWEB**; default password is **admin**.)
- **Moderator Password** lets you enter a four-digit number password for accessing the projector as a moderator using Epson iProjection. (No password is set by default.)
- **Projector Keyword** lets you turn on a security password to prevent access to the projector by anyone not in the room with it. You must enter a displayed, randomized keyword from a computer using Epson iProjection to access the projector and share the current screen.

- **Display Keyword** lets you select whether to display a projector keyword on the projected image when accessing the projector using Epson iProjection.
- **Display LAN Info.** lets you set the display format for the projector's network information.



Use the displayed keyboard to enter numbers and characters. Press the arrow buttons on the remote control to highlight characters and press [Enter] to select them.

5 Select the **Wired LAN** menu and press [Enter].

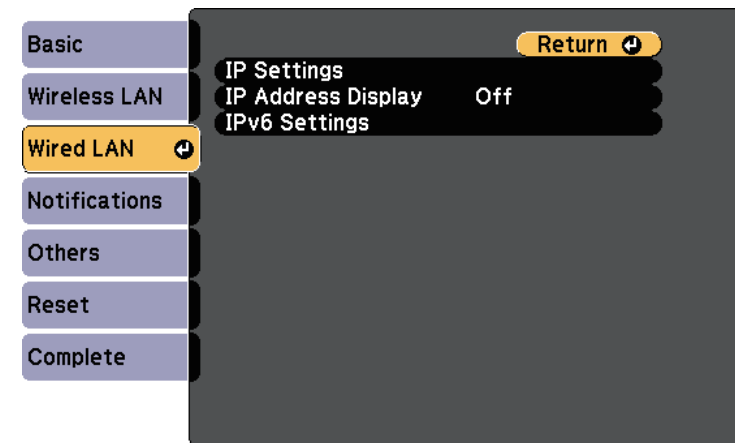

6 Assign the IP settings for your network as necessary.

- If your network assigns addresses automatically, select **IP Settings** to set the **DHCP** setting to **On**.
- If you must set addresses manually, select **IP Settings** to set the **DHCP** setting to **Off**, and then enter the projector's **IP Address**, **Subnet Mask**, and **Gateway Address** as necessary.
- If you want to connect the projector to the network using IPv6, select **IPv6 Settings** to set the **IPv6** setting to **On**, and then set the **Auto Configuration** and **Use Temporary Address** settings as necessary.



To highlight the numbers you want from the displayed keyboard, press the arrow buttons on the remote control. To select a highlighted number, press [Enter].

- 7** To prevent the IP address from being displayed on the LAN standby screen and Home screen, set the **IP Address Display** setting to **Off**.
- 8** When you finish selecting settings, select **Complete** and follow the on-screen instructions to save your settings and exit the menus.
- 9** Press the [LAN] button on the remote control.
The wired network settings complete when you see the correct IP address on the LAN standby screen.

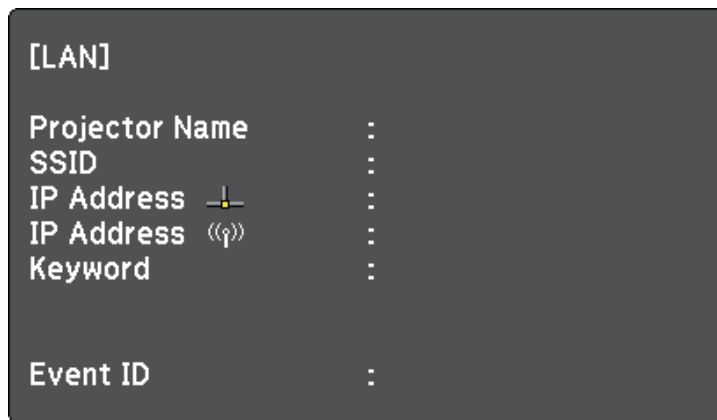

You can send images to your projector through a wireless network.

- To do this, you must install the Epson 802.11b/g/n wireless LAN module, and then set up your projector and computer for wireless projection (EB-W50/EB-X50).
- Some models have built-in wireless LAN modules (EB-U50). You don't need to install the Epson 802.11b/g/n wireless LAN module.

You can connect the projector to your wireless network by configuring the connection manually using the projector's **Network** menus.

After installing the wireless LAN module and setting up the projector, download and install the necessary network software. Use the following software and documentation to set up and control wireless projection.

- Epson iProjection (Windows/Mac) software allows you to hold interactive meetings by projecting the computer screens of users over a network. See the *Epson iProjection Operation Guide (Windows/Mac)* for instructions.
- Epson iProjection (iOS/Android) app allows you to project from iOS or Android devices.

You can download Epson iProjection from the App Store or Google Play. Any fees incurred when communicating with the App Store or Google Play are the responsibility of the customer.

- Epson iProjection (Chromebook) app allows you to project from Chromebook devices.

You can download Epson iProjection from the Chrome Web Store. Any fees incurred when communicating with the Chrome Web Store are the responsibility of the customer.

» Related Links

- "Installing the Wireless LAN Module" [p.89](#)
- "Selecting Wireless Network Settings Manually" [p.90](#)
- "Selecting Wireless Network Settings in Windows" [p.92](#)
- "Selecting Wireless Network Settings in Mac" [p.92](#)
- "Setting Up Wireless Network Security" [p.92](#)
- "Using a QR Code to Connect a Mobile Device" [p.95](#)
- "Using a USB Key to Connect a Windows Computer" [p.95](#)

Installing the Wireless LAN Module

To use the projector over a wireless network, install the Epson 802.11b/g/n wireless LAN module (EB-W50/EB-X50). Do not install any other type of wireless LAN module.

Attention

Never remove the module while its indicator is blue or flashing, or while you are projecting wirelessly. This could damage the module or lose data.

- 1** Use a cross-head screwdriver to remove the screw that secures the wireless LAN module cover.

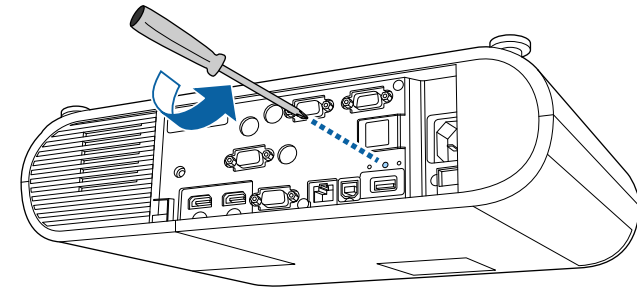

- 2** Connect the wireless LAN module to the USB-A port.

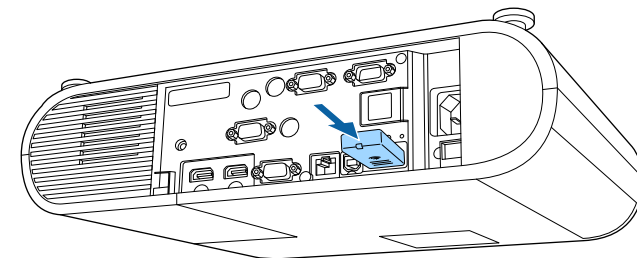

- 3 Attach the wireless LAN module cover, and secure it in place with the screw.

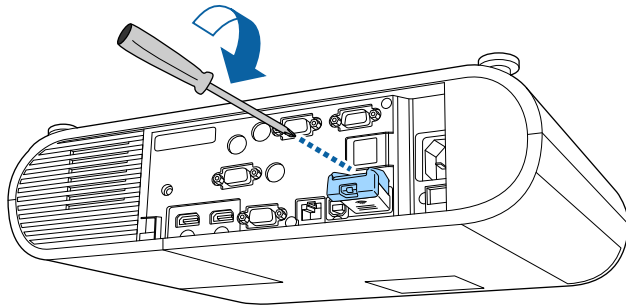

Selecting Wireless Network Settings Manually

Before you can project from your wireless network, you need to select network settings for the projector.

- 1 Press the [Menu] button, select the **Network** menu, and press [Enter].

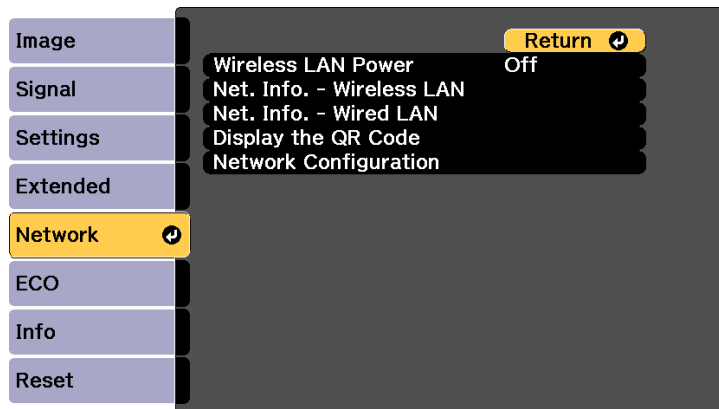

- 2 Select **On** as the **Wireless LAN Power** setting.

- 3 Select **Network Configuration** and press [Enter].

- 4 Select the **Basic** menu and press [Enter].

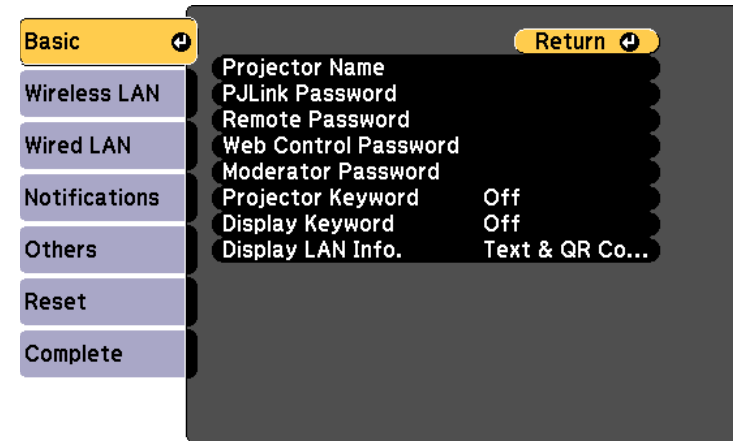

- 5 Select the basic options as necessary.

- **Projector Name** lets you enter a name up to 16 alphanumeric characters long to identify the projector over the network.
- **PjLink Password** lets you enter a password up to 32 alphanumeric characters long for using the PjLink protocol for projector control.
- **Remote Password** lets you enter a password up to 8 alphanumeric characters long for accessing the projector using the Basic Control. (User name is **EPSONREMOTE**; default password is **guest**.)
- **Web Control Password** lets you enter a password up to 8 alphanumeric characters long for accessing the projector over the Web. (User name is **EPSONWEB**; default password is **admin**.)
- **Moderator Password** lets you enter a four-digit number password for accessing the projector as a moderator using Epson iProjection. (No password is set by default.)
- **Projector Keyword** lets you turn on a security password to prevent access to the projector by anyone not in the room with it. You must enter a displayed, randomized keyword from a computer using

Epson iProjection to access the projector and share the current screen.

- **Display Keyword** lets you select whether to display a projector keyword on the projected image when accessing the projector using Epson iProjection.
- **Display LAN Info.** lets you set the display format for the projector's network information.



Use the displayed keyboard to enter numbers and characters. Press the arrow buttons on the remote control to highlight characters and press [Enter] to select them.

6 Select the **Wireless LAN** menu and press [Enter].

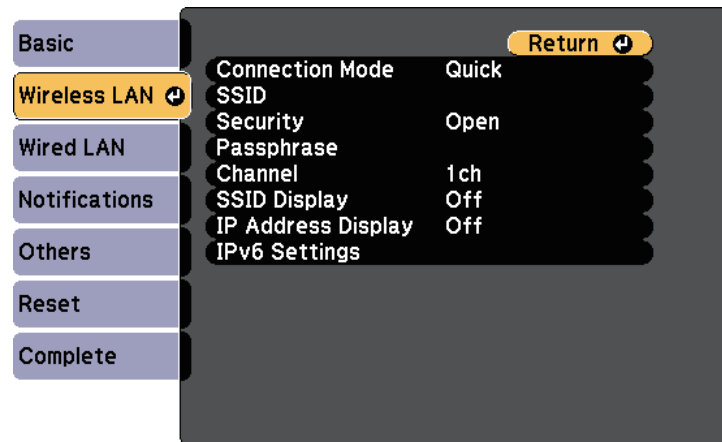

7 Select the **Connection Mode** setting.

- **Quick** lets you connect to multiple smartphones, tablets, or computers directly using wireless communication.
- **Advanced** lets you connect to smartphones, tablets, or computers over a wireless network access point.

8 If you selected the **Advanced** connection mode, select **Search Access Point** to select the access point you want to connect to.



If you need to assign the SSID manually, select **SSID** to enter the SSID.

9 For the **Advanced** connection mode, assign the IP settings for your network as necessary.

- If your network assigns addresses automatically, select **IP Settings** to set the **DHCP** setting to **On**.
- If you must set addresses manually, select **IP Settings** to set the **DHCP** setting to **Off**, and then enter the projector's **IP Address**, **Subnet Mask**, and **Gateway Address** as necessary.
- If you want to connect the projector to the network using IPv6, select **IPv6 Settings** to set the **IPv6** setting to **On**, and then set the **Auto Configuration** and **Use Temporary Address** settings as necessary.

10 To prevent the SSID or IP address from being displayed on the LAN standby screen and Home screen, set the **SSID Display** setting or the **IP Address Display** setting to **Off**.

11 When you finish selecting settings, select **Complete** and follow the on-screen instructions to save your settings and exit the menus.

12 Press the [LAN] button on the remote control.

The wireless network settings are complete when you see the correct IP address on the LAN standby screen.

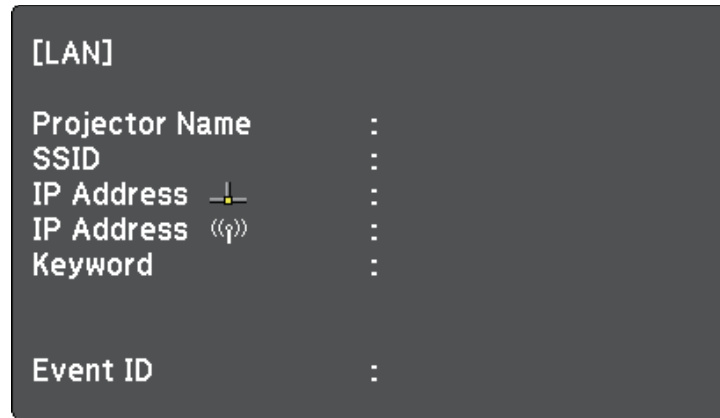

When you have finished making wireless settings for your projector, you need to select the wireless network on your computer. Then start the network software to send images to your projector through a wireless network.

Selecting Wireless Network Settings in Windows

Before connecting to the projector, select the correct wireless network on your computer.

- 1** To access your wireless utility software, click the network icon on the Windows taskbar.
- 2** When connecting in Advanced connection mode, select the network name (SSID) of the network the projector is connecting to.
- 3** Click **Connect**.

Selecting Wireless Network Settings in Mac

Before connecting to the projector, select the correct wireless network in Mac.

- 1** Click the Wi-Fi icon on the menu bar at the top of the screen.
- 2** When connecting in Advanced connection mode, make sure Wi-Fi is turned on and select the network name (SSID) of the network the projector is connecting to.

Setting Up Wireless Network Security

You can set up security for your projector to use on a wireless network. Set up one of the following security options to match the settings used on your network:

- WPA2-PSK security
- WPA2-EAP security *
- WPA/WPA2-PSK security *
- WPA/WPA2-EAP security *

* Available only for the Advanced connection mode.



Contact your network administrator for guidance on entering the correct information.

- 1** If you want to set up the WPA2-EAP or WPA/WPA2-EAP security, make sure your digital certificate file is compatible with projector registration and placed directly on the USB storage device.
- 2** Press the [Menu] button, select the **Network** menu, and press [Enter].
- 3** Select **Network Configuration** and press [Enter].

4 Select the **Wireless LAN** menu and press [Enter].

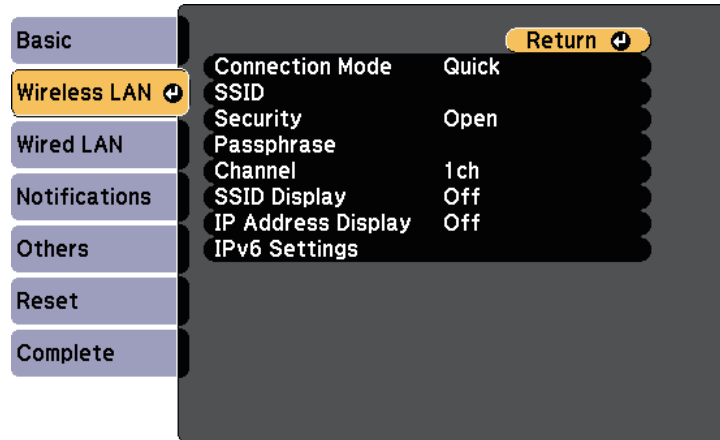

5 Select the **Security** setting and press [Enter].

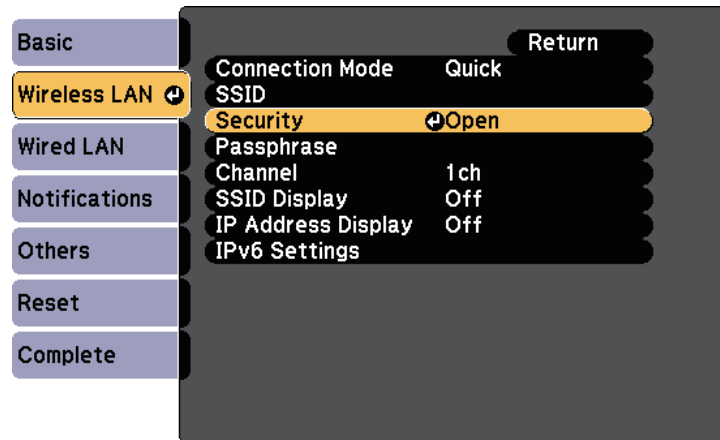

6 Select the security settings to match your network settings.

7 Do one of the following according to the security you selected.

- **WPA2-PSK, WPA/WPA2-PSK:** Select **Complete** and follow the on-screen instructions to save your settings and exit the menus.
- **WPA2-EAP, WPA/WPA2-EAP:** Select **EAP Method** and press [Enter].

8 Select the protocol for authentication as the **EAP Type** setting.

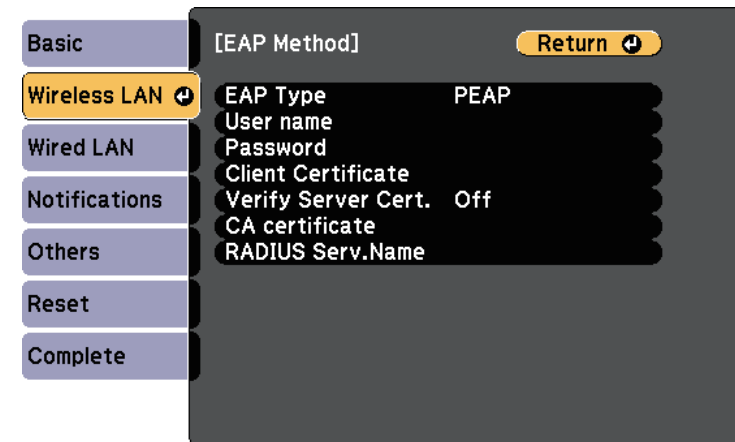

9 To import your certificate, select the certificate type and press [Enter].

- **Client Certificate** for the **PEAP-TLS** or **EAP-TLS** type
- **CA certificate** for the **PEAP, PEAP-TLS, EAP-TLS, or EAP-FAST** type



You can also register the digital certificates from your Web browser. However, be sure to register just once or the certificate may not install correctly.

10 Select **Register** and press [Enter].

11 Follow the on-screen instructions to connect a USB storage device to the projector's USB-A port.

- 12** Press [Enter] to display the certificate list.
- 13** Select the certificate to import using the displayed list.
A message is displayed prompting you to enter the password for the certificate.
- 14** Enter a password and press [Enter].
The certificate is imported and a completion message appears.
- 15** Select your EAP settings as necessary.
 - **User name** lets you enter a user name using up to 63 alphanumeric characters. To enter more than 32 characters, use your Web browser. When importing a client certificate, the name the certificate was issued to is automatically set.
 - **Password** lets you enter a password using up to 63 alphanumeric characters for authentication when using the **PEAP**, **EAP-FAST**, or **LEAP** type. To enter more than 32 characters, use your Web browser.
 - **Verify Server Cert.** lets you select whether or not to verify the server certificate when a CA certificate has been set.
 - **RADIUS Serv.Name** lets you enter the server name to be verified.

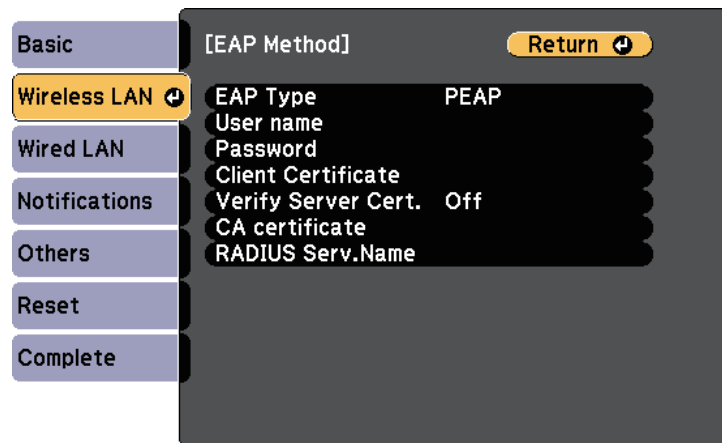

- 16** When you have finished making settings, select **Complete** and follow the on-screen instructions to save your settings and exit the menus.

» **Related Links**

- "Supported Client and CA Certificates" [p.94](#)
- "Network Menu - Wireless LAN Menu" [p.138](#)

Supported Client and CA Certificates

You can register these types of digital certificates.

Client Certificate (PEAP-TLS/EAP-TLS)

| Specification | Description |
|---------------|--|
| Format | PKCS#12 |
| Extension | PFX, P12 |
| Encryption | RSA |
| Hashes | MD5/SHA-1/SHA-256/SHA-384/SHA-512 |
| Key length | 512/1024/2048/4096 bit |
| Password * | Up to 32 alphanumeric characters; required |

CA Certificate (PEAP/PEAP-TLS/EAP-TLS/EAP-FAST)

| Specification | Description |
|---------------|-----------------------------------|
| Format | X509v3 |
| Extension | DER/CER/PEM |
| Encryption | RSA |
| Hashes | MD5/SHA-1/SHA-256/SHA-384/SHA-512 |
| Key length | 512/1024/2048/4096 bit |
| Encoding | BASE64/Binary |

* You can set a password using up to 64 alphanumeric characters. However, you need to use your Web browser to enter more than 32 characters.

Using a QR Code to Connect a Mobile Device

After selecting the wireless network settings for your projector, you can display a QR code on the screen and use it to connect a mobile device using the Epson iProjection (iOS/Android) app.



- Make sure you have installed the latest version of Epson iProjection on your device (V1.3.0 or later supports this feature).
- You can download Epson iProjection for free from the App Store or Google Play. Any fees incurred when communicating with the App Store or Google Play are the responsibility of the customer.
- When using Epson iProjection in Quick connection mode, we recommend making security settings.

- 1** Press the [LAN] button on the remote control.
The QR code is displayed on the projected surface.



- If you do not see the QR code, set the **Display LAN Info.** setting to **Text & QR Code** in the projector's **Network** menu.
 🖱️ **Network > Network Configuration > Basic > Display LAN Info.**
- To hide the QR code, press [Esc].
- When the QR code is hidden, press [Enter] to display the code.

- 2** Start Epson iProjection on your mobile device.
- 3** Read the projected QR code using Epson iProjection to connect it to the projector.



To correctly read the QR code, make sure you face the screen squarely and closely enough so that the projected code fits into the guide of the mobile device's QR code reader. If you are too far from the screen, the code may not be read.

When a connection is established, select **Contents** menu from , and then select the file you want to project.

Using a USB Key to Connect a Windows Computer

You can set up your USB flash drive as a USB key to quickly connect the projector to a wireless LAN supported Windows computer. After creating the USB key, you can quickly project images from the network projector.

- 1** Set up the USB key using Epson iProjection (Windows/Mac) software.



See the *Epson iProjection Operation Guide (Windows/Mac)* for instructions.

- 2** Make sure the wireless LAN module is installed or built into your projector.
- 3** Turn on the projector.
- 4** Press the [LAN] button on the remote control.
The LAN standby screen is displayed. Verify that an SSID and IP address are displayed.
- 5** Do one of the following to connect the USB key.
 - Connect the USB key to the projector's USB-A port (EB-U50).
 - Remove the wireless LAN module from the projector and insert the USB key into the same port used for the wireless LAN module (EB-W50/EB-X50).

You see a projected message that the network information update is complete.

- 6** Remove the USB key.
If your projector needs the wireless LAN module, reinsert the wireless LAN module into the projector.
- 7** Connect the USB key to a USB port on your computer.

8 Follow the on-screen instructions to install the necessary application.



- If the Windows Firewall message is displayed, click **Yes** to disable the firewall.
- You need administrator authority to install the software.
- If it is not installed automatically, double-click **MPPLaunch.exe** in the USB key.

After a few minutes, your computer image is displayed by the projector.

9 When you have finished projecting wirelessly, select the **Safely Remove Hardware** option in the Windows taskbar, and then remove the USB key from your computer.



You may need to restart your computer to reactivate your wireless LAN connection.

You can use the HTTPS protocol to increase security between the projector and a Web browser communicating with it. To do this, you create a server certificate, install it on the projector, and turn on the **Secure HTTP** setting in the projector menus to verify the reliability of the Web browser.

☛ **Network > Network Configuration > Others > Secure HTTP**

Even if you do not install a server certificate, the projector automatically creates a self-signed certificate and allows communication. However, because the self-signed certificate cannot verify reliability from a Web browser, you see a warning about the server's reliability when you access the projector from a Web browser. This warning does not prevent communication.

» **Related Links**

- "Importing a Web Server Certificate Using the Menus" [p.97](#)

Importing a Web Server Certificate Using the Menus

You can create your Web server certificate, and import it using the projector menus and a USB flash drive.



You can also register the digital certificates from your Web browser. However, be sure to register just once or the certificate may not install correctly.

- 1** Make sure your digital certificate file is compatible with projector registration and directly placed on the USB storage device.
- 2** Press the [Menu] button, select the **Network** menu, and press [Enter].
- 3** Select **Network Configuration** and press [Enter].

- 4** Select the **Others** menu and press [Enter].

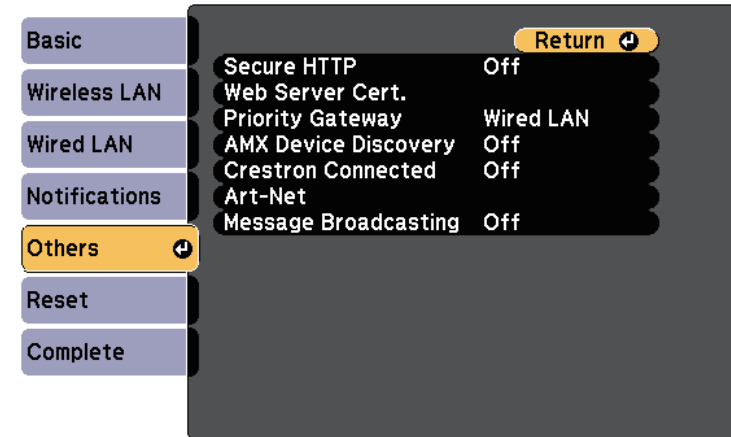

- 5** Select **On** as the **Secure HTTP** setting.
- 6** Select **Web Server Cert.** and press [Enter].
- 7** Select **Register** and press [Enter].
- 8** Follow the on-screen instructions to connect a USB storage device to the projector's USB-A port.
- 9** Press [Enter] to display the certificate list.
- 10** Select the certificate to import using the displayed list.
A message is displayed prompting you to enter the password for the certificate.
- 11** Enter a password and press [Enter].
The certificate is imported and a completion message appears.

» Related Links

- "Supported Web Server Certificates" [p.98](#)

Supported Web Server Certificates

You can register these types of digital certificates.

Web Server Certificate (Secure HTTP)

| Specification | Description |
|---------------|--|
| Format | PKCS#12 |
| Extension | PFX, P12 |
| Encryption | RSA |
| Hashes | MD5/SHA-1/SHA-256/SHA-384/SHA-512 |
| Key length | 512/1024/2048/4096 bit |
| Common name | Network host name |
| Organization | Optional |
| Password * | Up to 32 alphanumeric characters; required |

* You can set a password using up to 64 alphanumeric characters. However, you need to use your Web browser to enter more than 32 characters.

Monitoring and Controlling the Projector

Follow the instructions in these sections to monitor and control the projector over a network.

► Related Links

- "Epson Projector Management" [p.100](#)
- "Controlling a Networked Projector Using a Web Browser" [p.101](#)
- "Controlling a Networked Projector in Content Playback Mode" [p.104](#)
- "Registering Digital Certificates from a Web Browser" [p.109](#)
- "Setting Up Projector Network E-Mail Alerts" [p.110](#)
- "Setting Up Monitoring Using SNMP" [p.111](#)
- "Using ESC/VP21 Commands" [p.112](#)
- "PJLink Support" [p.114](#)
- "Crestron Connected Support" [p.115](#)
- "Art-Net Channel Definitions" [p.120](#)
- "Setting Projector Event Schedules" [p.122](#)

Epson Projector Management software (Windows only) lets you monitor and control your projector through the network. See the *Epson Projector Management Operation Guide* for instructions.

You can download Epson Projector Management from the following Web site.

<http://www.epson.com/>

Once you have connected your projector to your network, you can select projector settings and control projection using a compatible Web browser. This lets you access the projector remotely.



- Make sure the computer and projector are connected to the network. When projecting images using a wireless LAN, connect in **Advanced** connection mode.
- You can use the following Web browsers.
 - Internet Explorer 11 or later (Windows)
 - Microsoft Edge (Windows)
 - Safari (Mac, iOS)
 - Chrome (Android)
- While using the Web browser, do not connect using a proxy server. You cannot select all of the projector menu settings or control all projector functions using a Web browser.
- If you set **Standby Mode** to **Communication On**, you can use a Web browser to select settings and control projection even if the projector is in standby mode (when the power is off).
 - **ECO > Standby Mode > Standby Mode**

You see the Epson Web Control screen.

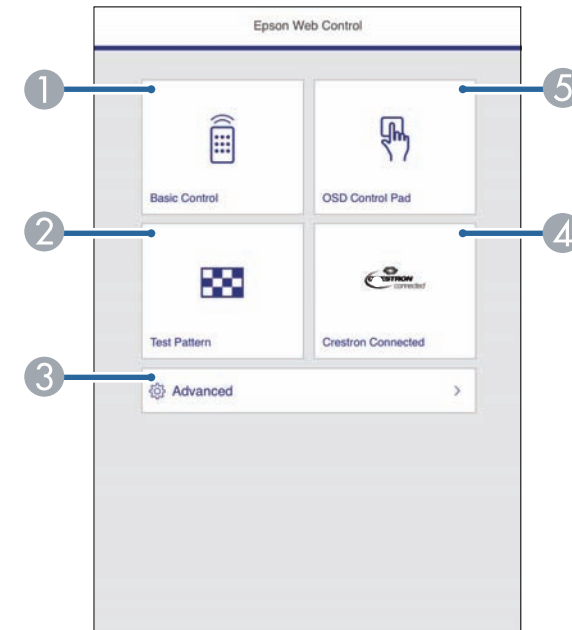

- 1** Make sure the projector is turned on.
- 2** Make sure your computer or device is connected to the same network as the projector.
- 3** Start your Web browser on the computer or device.
- 4** Go to the Epson Web Control screen by entering the projector's IP address into the browser's address box. When entering an IPv6 address, wrap the address with [and].

- 1** Controls the projector remotely.
- 2** Displays a test pattern.
- 3** Sets detailed projector settings.
- 4** Opens the Crestron Connected operation window. Available only when you set the Crestron Connected system.
- 5** Operates the projector's menu settings with your finger or mouse.

- 5** Select the option corresponding to the projector function you want to control.



- You may need to log in to access some of the options on the Epson Web Control screen. If you see a log in window, enter your user name and password. (The user name is **EPSONWEB** and the default password is **admin**.)
- You can change the password in **Web Control Password** in the projector's **Network** menu.
 - ☛ **Network > Network Configuration > Basic > Web Control Password**
- You can only select the following settings from **Advanced**.
 - Monitor Password (up to 16 alphanumeric characters)
 - IPv6 Settings (manual)
 - HTTP port (port number used for Web Control except for 80 [default], 843, 3620, 3621, 3625, 3629, 4352, 4649, 5357, 10000, 10001, 41794)

» Related Links

- "Web Control Options" [p.102](#)
- "Projector Setup Settings - ECO Menu" [p.144](#)
- "Network Menu - Basic Menu" [p.137](#)

Web Control Options

Basic Control



- If you see a log in window, enter your user name and password. (The user name is **EPSONREMOTE** and the default password is **guest**.)
- You can change the password in **Remote Password** in the projector's **Network** menu.
 - ☛ **Network > Network Configuration > Basic > Remote Password**

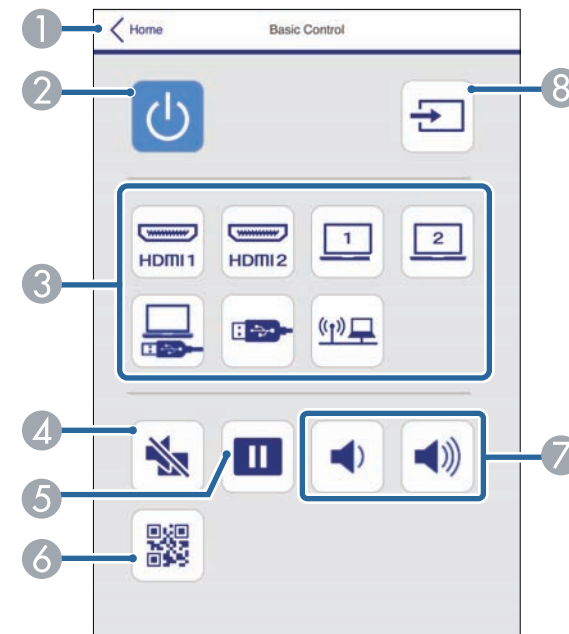

- 1 Returns to the Epson Web Control screen.
- 2 Turns the projector on or off.
- 3 Selects the input source.
- 4 Turns the video and audio on or off temporarily.

- ⑤ Pauses or resumes images.
- ⑥ Displays the QR code.
- ⑦ Adjusts the speaker volume.
- ⑧ Searches for sources.

OSD Control Pad

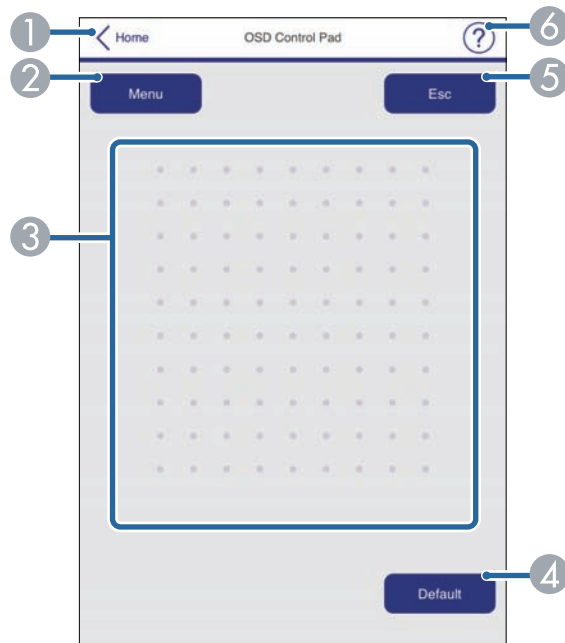

- ① Returns to the Epson Web Control screen.
- ② Displays the projector's setting menus.
- ③ Use your finger or mouse to navigate the menus.
- ④ Returns the selected setting to its default value.
- ⑤ Returns to the previous menu.
- ⑥ Displays help topics.



You cannot change the following settings using Epson Web Control.

- Image Shift
- User Button
- User's Logo
- HDMI EQ Setting
- Language
- Content Playback
- Reset Lamp Hours

Test Pattern

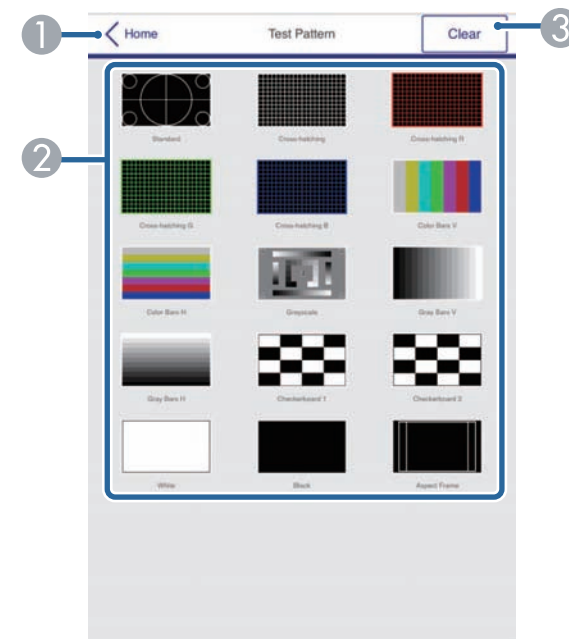

- ① Returns to the Epson Web Control screen.
- ② Displays available test patterns; select to project a test pattern.
- ③ Turns off test pattern display.

In Content Playback mode, you can select projector settings, control projection, and edit playlists using a Web browser.



You can also control the projector using a Web browser through the Epson iProjection (iOS/Android) app.

Attention

Do not remove the USB flash drive from the projector or disconnect the projector's power cord in the following situations. Data saved on the USB flash drive may be damaged.

- When the Playlists screen is displayed
- When the USB Memory Device screen is displayed

- 1** Make sure the projector is operating in Content Playback mode.
- 2** Make sure your computer or device is connected to the same network as the projector.
- 3** Start your Web browser on the computer or device.
- 4** Go to the Epson Web Control screen by entering the projector's IP address into the browser's address box. When entering an IPv6 address, wrap the address with [and].

The Epson Web Control screen is displayed.

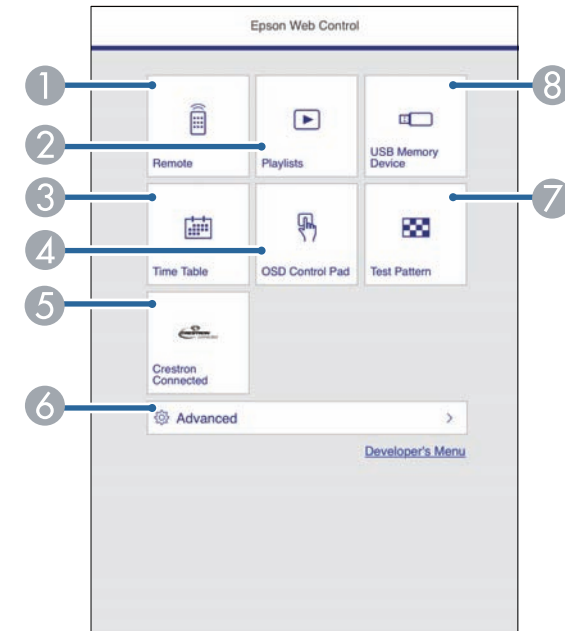

- 1** Controls the projector remotely.
- 2** Edits playlists for Content Playback mode.
- 3** Opens the Time Table screen.
- 4** Operates the projector's menu settings with your finger or mouse.
- 5** Opens the Crestron Connected operation window. Available only when you set the Crestron Connected system.
- 6** Sets detailed projector settings.
- 7** Displays a test pattern.
- 8** Registers or deletes the data for a playlist on the USB flash drive.

- 5** Select the option corresponding to the projector function you want to control.



- You may need to log in to access some of the options on the Epson Web Control screen. If you see a log in window, enter your user name and password. (The user name is **EPSONWEB** and the default password is **admin**.)
- You can change the password in **Web Control Password** in the projector's **Network** menu.
 - ☛ **Network > Network Configuration > Basic > Web Control Password**
- You can only select the following settings from **Advanced**.
 - Monitor Password (up to 16 alphanumeric characters)
 - IPv6 Settings (manual)
 - HTTP port (port number used for Web Control except for 80 [default], 843, 3620, 3621, 3625, 3629, 4352, 4649, 5357, 10000, 10001, 41794)

» Related Links

- "Web Control Options in Content Playback Mode" [p.105](#)

Web Control Options in Content Playback Mode

Remote



- 1 Returns to the Epson Web Control screen.
- 2 Turns the projector on or off.
- 3 Selects the input source.
- 4 Turns the video and audio on or off temporarily.
- 5 Selects your favorite playlists.
- 6 Turns **Overlay Effect** on or off. Turn on to add color and shape effects to the projected image.
- 7 Adjusts the speaker volume.

Playlist

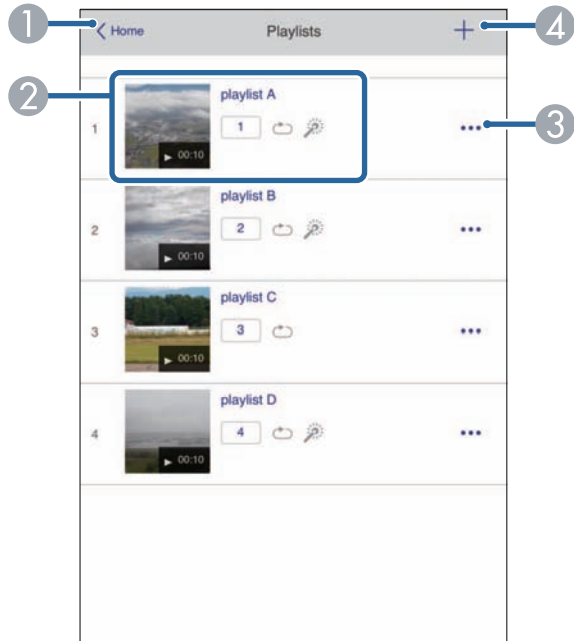

- ① Returns to the Epson Web Control screen.
- ② Controls playback of the playlist.
- ③ Edits, copies, or deletes the playlist.
- ④ Creates a new playlist.

USB Memory Device



- ① Returns to the Epson Web Control screen.
- ② Copies images or movies you want to add to playlists to a USB flash drive.
- ③ Deletes images or movies on the USB flash drive.

Time Table

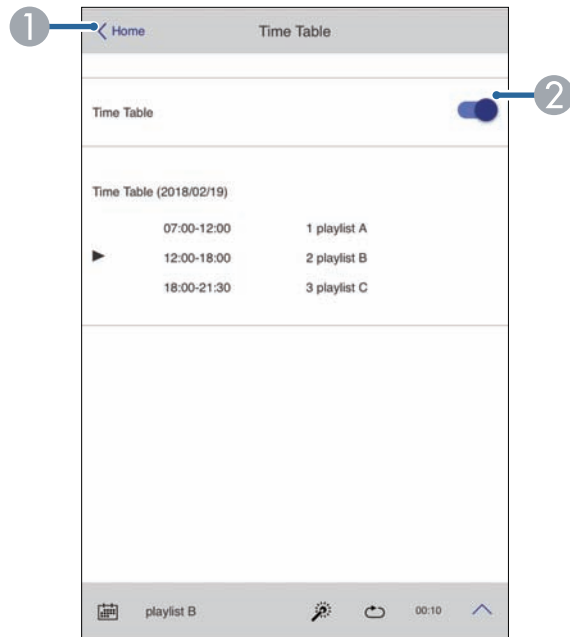

- ① Returns to the Epson Web Control screen.
- ② Turns the time table on or off.



You can specify when each playlist starts and finishes using the time table feature in the Epson Projector Content Manager software. For details, see the *Epson Projector Content Manager Operation Guide*.

OSD Control Pad

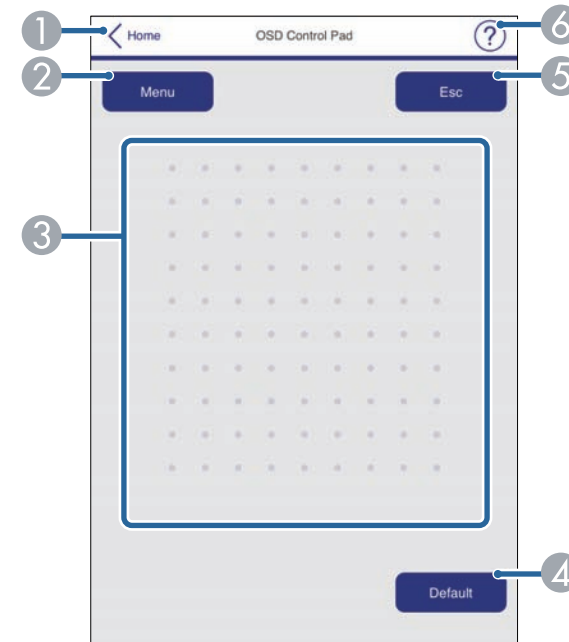

- ① Returns to the Epson Web Control screen.
- ② Displays the projector's setting menus.
- ③ Use your finger or mouse to navigate the menus.
- ④ Returns the selected setting to its default value.
- ⑤ Returns to the previous menu.
- ⑥ Displays help topics.



You cannot change the following settings using Epson Web Control.

- Image Shift
- User Button
- User's Logo
- HDMI EQ Setting
- Language
- Content Playback
- Reset Lamp Hours

You can register the digital certificates on the projector to provide security for your presentation files.



You can also register the digital certificates in the projector's **Network** menu. However, be sure to register just once or the certificate may not install correctly.

☛ **Network > Network Configuration > Wireless LAN > EAP Method > Client Certificate**

☛ **Network > Network Configuration > Wireless LAN > EAP Method > CA certificate**

☛ **Network > Network Configuration > Others > Web Server Certificate**

- 1** Make sure your digital certificate file is compatible with projector registration.
- 2** Make sure the projector is turned on.
- 3** Start your Web browser on a computer or device connected to the network.
- 4** Go to the Epson Web Control screen by entering the projector's IP address into the browser's address box.
You see the Epson Web Control screen.
- 5** Select **Advanced**.



- You may need to log in before you see the Advanced screen. If a login screen is displayed, enter your user name and password. (The user name is **EPSONWEB** and the default password is **admin**.)
- You can change the password in **Web Control Password** in the projector's **Network** menu.
☛ **Network > Network Configuration > Basic > Web Control Password**

- 6** Under **Network**, select **Certificate**.
- 7** Select the certificate file you want to register.
- 8** Enter the password in the **Password** box, and then click **Set**.
- 9** When you finish registering the certificate, click **Apply** to finalize your changes and complete the registration.

You can set up the projector to send you an e-mail alert over the network if there is a problem with the projector.

If you set the **Standby Mode** setting to **Communication On**, you can receive the e-mail alerts even if the projector is in standby mode (when the power is off).

☛ **ECO > Standby Mode > Standby Mode**

- 1** Press the [Menu] button, select the **Network** menu, and press [Enter].
- 2** Select **Network Configuration** and press [Enter].
- 3** Select the **Notifications** menu and press [Enter].

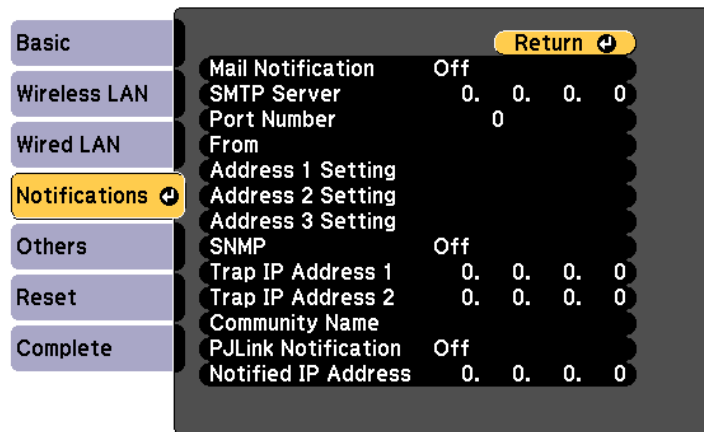

- 4** Set the **Mail Notification** setting to **On**.
- 5** Enter the IP address for the **SMTP Server** option.

 Do not use "127.x.x.x" (where x is a number from 0 to 255) for the **SMTP Server**.

- 6** Select a number for the SMTP server **Port Number**, from 0 to 65535 (default is 25).
- 7** Enter the e-mail address to be indicated as the sender in **From**.
- 8** Choose an address field, enter the e-mail address, and select the alerts you want to receive. Repeat for up to three addresses.

 Your e-mail address can be up to 32 alphanumeric characters long.

- 9** When you finish selecting settings, select **Complete** and follow the on-screen instructions to save your settings and exit the menus.

 If a critical problem causes a projector to shut down, you may not receive an e-mail alert.

» Related Links

- "Network Projector E-mail Alert Messages" [p.110](#)
- "Projector Setup Settings - ECO Menu" [p.144](#)

Network Projector E-mail Alert Messages

When a problem occurs with a projector on the network, and you selected to receive e-mail alerts, you receive an e-mail containing the following information:

- The email address set in **From** as the mail sender
- **Epson Projector** in the subject line
- The name of the projector experiencing a problem
- The IP address of the affected projector
- Detailed information about the problem

Network administrators can install SNMP (Simple Network Management Protocol) software on network computers so they can monitor projectors. If your network uses this software, you can set up the projector for SNMP monitoring.

- 1 Press the [Menu] button, select the **Network** menu, and press [Enter].
- 2 Select **Network Configuration** and press [Enter].
- 3 Select the **Notifications** menu and press [Enter].

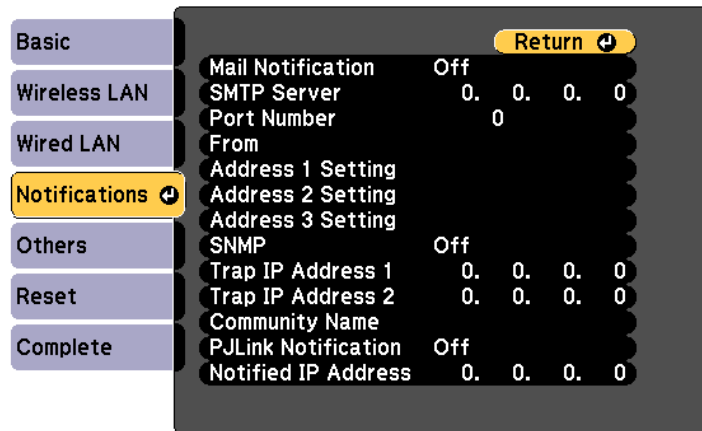

- 4 Set the **SNMP** setting to **On**.
- 5 Enter up to two IP addresses to receive SNMP notifications, using 0 to 255 for each address field.



Do not use these addresses: 224.0.0.0 through 255.255.255.255 (where x is a number from 0 to 255). This projector supports SNMP agent version 1 (SNMPv1).

- 6 Enter the SNMP **Community Name** up to 32 alphanumeric characters long.

- 7 When you finish selecting settings, select **Complete** and follow the on-screen instructions to save your settings and exit the menus.

You can control the projector from an external device using ESC/VP21.

► **Related Links**

- "ESC/VP21 Command List" [p.112](#)
- "Cable Layouts" [p.112](#)

ESC/VP21 Command List

When the power ON command is transmitted to the projector, the power turns on and it enters warm-up mode. When the projector's power has turned on, a colon ":" (3Ah) is returned.

When a command is input, the projector executes the command and returns a ":", and then accepts the next command.

If the command being processed terminates abnormally, an error message is output and a ":" is returned.

The following commands are available.

| Item | | Command |
|--------------|-----|---------|
| Power On/Off | On | PWR ON |
| | Off | PWR OFF |

| Item | | | Command |
|------------------|-------------|-----------|-----------|
| Signal selection | Computer1 | Auto | SOURCE 1F |
| | | RGB | SOURCE 11 |
| | | Component | SOURCE 14 |
| | Computer2 | Auto | SOURCE 2F |
| | | RGB | SOURCE 21 |
| | | Component | SOURCE 24 |
| | HDMI1 | | SOURCE 30 |
| | HDMI2 | | SOURCE A0 |
| | USB Display | | SOURCE 51 |
| | USB | | SOURCE 52 |
| | LAN | | SOURCE 53 |
| Spotlight | | SOURCE 58 | |
| A/V Mute On/Off | On | MUTE ON | |
| | Off | MUTE OFF | |

Add a Carriage Return (CR) code (0Dh) to the end of each command and transmit.

Contact Epson for more details.

Cable Layouts

Serial connection

- Connector shape: D-Sub 9-pin (male)
- Projector input port name: RS-232C
- Cable type: Crossover (null modem) cable

In the following illustration, the projector side is shown on the left, and the computer side on the right:

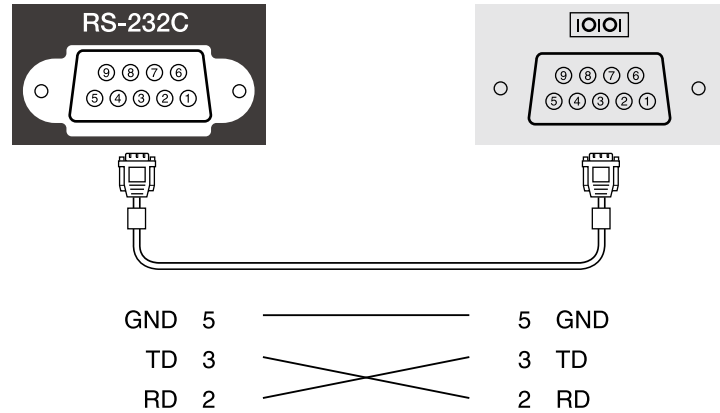

| Signal name | Function |
|-------------|--------------------|
| GND | Signal wire ground |
| TD | Transmit data |
| RD | Receive data |

Communications protocol

- Default baud rate setting: 9600 bps
- Data length: 8 bit
- Parity: None
- Stop-bit: 1 bit
- Flow control: None

PJLink was established by the JBMIA (Japan Business Machine and Information System Industries Association) as a standard protocol for controlling network-compatible projector's as part of their efforts to standardize projector control protocols.

The projector complies with the PJLink Class2 standard established by the JBMIA.

The port number used for the PJLink search function is 4352 (UDP).

You need to make network settings before you can use PJLink.

It complies with all commands except for the following commands defined by PJLink Class2, and agreement was confirmed by the PJLink standard adaptability verification.

<http://pjlink.jbmia.or.jp/english/>

- Non-compatible commands

| Function | | PJLink command |
|---------------|------------------|----------------|
| Mute settings | Image muting set | AVMT 11 |
| | Audio muting set | AVMT 21 |

- Input ports and corresponding input source number

| Input port name | Input source number |
|-----------------|---------------------|
| Computer1 | 11 |
| Computer2 | 12 |
| HDMI1 | 32 |
| HDMI2 | 33 |
| USB | 41 |
| Spotlight | 44 |
| LAN | 52 |
| USB Display | 53 |

- Manufacturer name displayed for "Manufacture name information query"

EPSON

- Model name displayed for "Product name information query"

- EPSON U50
- EPSON W50
- EPSON X50

► Related Links

- "Using the Projector on a Network" [p.85](#)

If you are using the Crestron Connected network monitoring and control system, you can set up your projector for use on the system. Crestron Connected lets you control and monitor your projector using a Web browser.



- You cannot use the Message Broadcasting feature in Epson Projector Management when you use Crestron Connected.
- If you set the **Standby Mode** setting to **Communication On**, you can control the projector even if the projector is in standby mode (when the power is off).
 - ☛ **ECO > Standby Mode > Standby Mode**

For additional information on Crestron Connected, visit the Crestron Web site.

<https://www.crestron.com/products/line/crestron-connected>

To monitor devices in the system, you can use Crestron RoomView Express or Crestron Fusion provided by Crestron. You can communicate with the help desk and send emergency messages. See the following Web site for details.

<http://www.crestron.com/getroomview>

This manual describes how to perform operations on your computer using a Web browser.

» **Related Links**

- "Setting Up Crestron Connected Support" [p.115](#)
- "Controlling a Networked Projector Using Crestron Connected" [p.115](#)
- "Projector Setup Settings - ECO Menu" [p.144](#)

Setting Up Crestron Connected Support

To set up your projector for monitoring and control using a Crestron Connected system, make sure your computer and projector are connected to the network. If you are connecting wirelessly, set up the projector using the Advanced network connection mode.

1 Press the [Menu] button, select the **Network** menu, and press [Enter].

2 Select **Network Configuration** and press [Enter].

3 Select the **Others** menu and press [Enter].

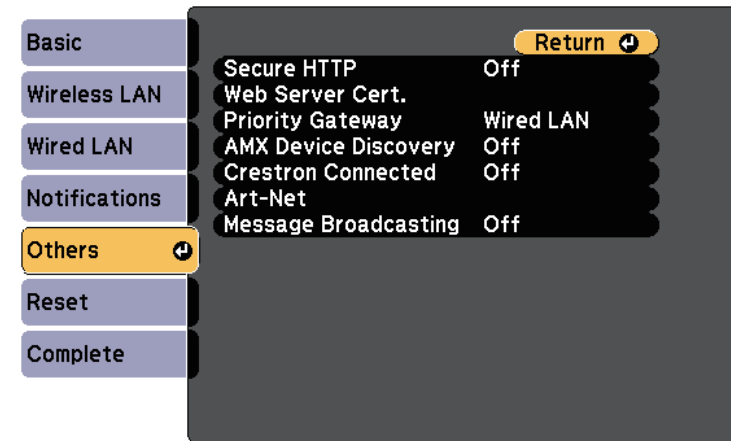

4 Set the **Crestron Connected** setting to **On** to allow the projector to be detected.

5 When you have finished selecting settings, select **Complete** and follow the on-screen instructions to save your settings and exit the menus.

6 Turn off the projector, and then turn it on again to enable the setting.

Controlling a Networked Projector Using Crestron Connected

Once you have set up your projector to use Crestron Connected, you can control and monitor projection using a compatible Web browser.

1 Start your Web browser on a computer connected to the network.

- 2 Type the projector's IP address into the browser's address box and press the computer's **Enter** key.

You see the Epson Web Control screen.

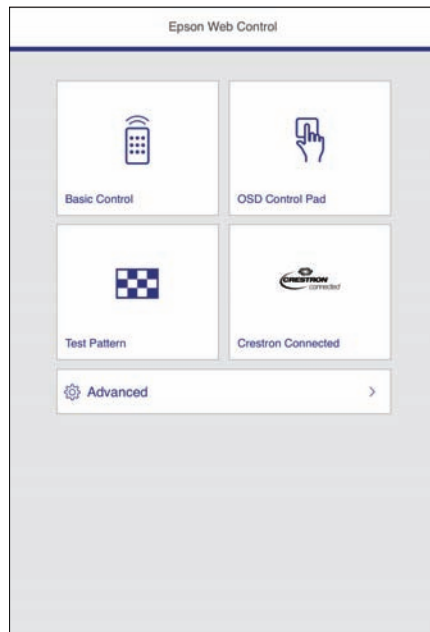

- 3 Select **Crestron Connected**.

You see this screen:



- 4 Select the input source that you want to control in the **Sources List** box. You can scroll through available sources using the up and down arrows in the box.
- 5 To control projection remotely, click the on-screen buttons that correspond to the projector's remote control buttons. You can scroll through button options at the bottom of the screen.



These on-screen buttons do not directly correspond to the projector's remote control buttons:

- **OK** acts as the [Enter] button
- **Menu** displays the projector's menu

- 6 To view information about the projector, click the **Info** tab.
- 7 To change the projector, Crestron Control, and password settings, click the **Tools** tab, select settings on the displayed screen, and then click **Send**.

8 When you finish selecting settings, click **Exit** to exit the program.

» **Related Links**

- "Crestron Connected Operation Window" p.117
- "Crestron Connected Tools Window" p.118

Crestron Connected Operation Window

Settings on the operation window let you control the projector and adjust the projection image.



| | | |
|---|---|--------------------------------------|
| 1 | Power | Turns the projector on or off. |
| | Vol-/Vol+ | Adjusts the volume. |
| | A/V Mute | Turns the video and audio on or off. |
| 2 | Switches to the image from the selected input source. To display input sources that are not shown in Sources List , click (a) or (b) to scroll up or down. The current video signal input source is displayed in blue. You can change the source name if necessary. | |

| | | |
|---|---------------|--|
| 3 | Freeze | Images are paused or released. |
| | Contrast | Adjusts the difference between light and shade in the images. |
| | Brightness | Adjusts the image brightness. |
| | Color | Adjusts the color saturation for the images. |
| | Sharpness | Adjusts the image sharpness. |
| | Zoom | Enlarges or reduces the image without changing the projection size. Click the arrow buttons to change the position of an enlarged image. |
| 4 | Arrow buttons | Performs the same operations as the arrow buttons on the remote control. |
| | OK | Performs the same operation as [Enter] on the remote control. |
| | Menu | Displays and closes the projector's menu. |
| | Auto | Optimizes Tracking , Sync. , and Position in the projector's Signal menu while projecting an analog RGB signal from Computer1 or Computer2 port. |
| | Search | Changes to the next input source that is sending an image. |
| | Esc | Performs the same operation as the [Esc] button on the remote control. |
| 5 | Tools | Changes settings in the projector that is currently connected. |
| | Info | Displays information on the projector that is currently connected. |
| | Help | Displays the Help Desk window. Used to send messages to, and receive messages from, the administrator using Crestron RoomView Express. |

Crestron Connected Tools Window

Settings on the Tools window let you customize various projector setup features.

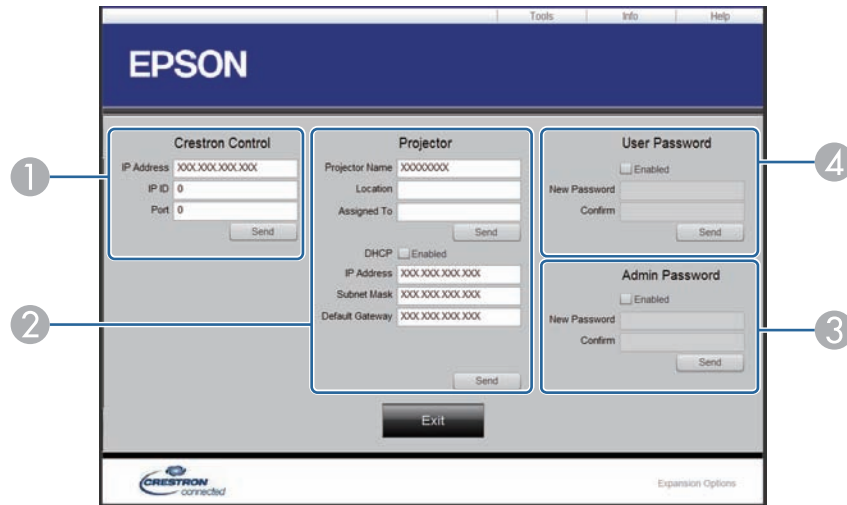

1 Make settings for Crestron central controllers.

| | | |
|---|--------------------------|--|
| 2 | Projector Name | Enter a name to differentiate the projector that is currently connected from other projectors on the network. (up to 16 alphanumeric characters) |
| | Location | Enter an installation location name for the projector that is currently connected on the network. (up to 32 alphanumeric characters and symbols) |
| | Assigned To | Enter a user name for the projector. (up to 32 alphanumeric characters and symbols) |
| | DHCP | Select to use DHCP. You cannot enter an IP address if DHCP is enabled. |
| | IP Address | Enter the IP address to assign to the currently connected projector. |
| | Subnet Mask | Enter a subnet mask for the currently connected projector. |
| | Default Gateway | Enter the gateway address for the currently connected projector. |
| | Send | Click to confirm the changes made to the Projector. |
| 3 | Enabled (Admin Password) | Select to require a password to open the Tools window. |
| | New Password | Enter the new password when changing the password to open the Tools window. (up to 26 alphanumeric characters) |
| | Confirm | Enter the same password as you entered in New Password . If the passwords are not the same, an error is displayed. |
| | Send | Click to confirm the changes made to the Admin Password . |

| | | |
|---|-------------------------|---|
| 4 | Enabled (User Password) | Select to require a password to open the operation window on the computer. |
| | New Password | Enter the new password when changing the password to open the operation window. (up to 26 alphanumeric characters) |
| | Confirm | Enter the same password as you entered in New Password . If the passwords are not the same, an error is displayed. |
| | Send | Click to confirm the changes made to the User Password . |

Art-Net is an Ethernet communication protocol based on the TCP/IP protocol. You can control the projector by using a DMX controller or an application system.

The following table lists the channel definitions used to control the projector in Art-Net.

| Channel/Function | Operation | Parameters | Default value | Description |
|-----------------------------|--|------------|---------------|-----------------------------------|
| 1 Adjusting light (dimming) | 0% to 100% | 0 to 255 | 0 | Adjusts the image brightness. |
| 2 Shutter control | Shutter open | 0 to 63 | 128 | Enables/disables A/V Mute. |
| | Non-operational | 64 to 191 | | |
| | Shutter closed | 192 to 255 | | |
| 3 Switch source | Non-operational | 0 to 7 | 0 | Switches to the specified source. |
| | HDMI1 | 8 to 15 | | |
| | HDMI2 | 16 to 23 | | |
| | Non-operational | 24 to 31 | | |
| | Non-operational (DVI-D) | 32 to 39 | | |
| | Non-operational (Display Port) | 40 to 47 | | |
| | Non-operational (SDI) | 48 to 55 | | |
| | Computer1 | 56 to 63 | | |
| | Computer2 | 64 to 71 | | |
| | Non-operational (BNC) | 72 to 79 | | |
| | LAN | 80 to 87 | | |
| | Non-operational (Reserved: Screen Mirroring) | 88 to 95 | | |

| Channel/Function | Operation | Parameters | Default value | Description |
|---------------------|---|------------|---------------|---|
| | Non-operational (Reserved: Screen Mirroring2) | 96 to 103 | | |
| | USB Display | 104 to 111 | | |
| | USB | 112 to 119 | | |
| | Spotlight | 120 to 127 | | |
| | Non-operational | 128 to 255 | | |
| 7 Zoom | Electronic Tele/Wide | 0 to 255 | 255 | Zooms using the specified amount of movement. |
| 10 Content playback | Non-operational | 0 to 3 | 0 | Plays the specified playlist. |
| | Playlist 1 | 4 to 7 | | |
| | Playlist 2 | 8 to 11 | | |
| | Playlist 3 | 12 to 15 | | |
| | Playlist 4 | 16 to 19 | | |
| | Playlist 5 | 20 to 23 | | |
| | Playlist 6 | 24 to 27 | | |
| | Playlist 7 | 28 to 31 | | |
| | Playlist 8 | 32 to 35 | | |
| | Playlist 9 | 36 to 39 | | |
| | Playlist 10 | 40 to 43 | | |
| | Playlist 11 | 44 to 47 | | |
| | Playlist 12 | 48 to 51 | | |
| | Playlist 13 | 52 to 55 | | |
| | Playlist 14 | 56 to 59 | | |
| | Playlist 15 | 60 to 63 | | |
| | Playlist 16 | 64 to 67 | | |

| Channel/Functi on | Operation | Parameters | Default value | Description |
|-------------------|-------------|------------|---------------|-------------|
| | Playlist 17 | 68 to 71 | | |
| | Playlist 18 | 72 to 75 | | |
| | Playlist 19 | 76 to 79 | | |
| | Playlist 20 | 80 to 83 | | |
| | Playlist 21 | 84 to 87 | | |
| | Playlist 22 | 88 to 91 | | |
| | Playlist 23 | 92 to 95 | | |
| | Playlist 24 | 96 to 99 | | |
| | Playlist 25 | 100 to 103 | | |
| | Playlist 26 | 104 to 107 | | |
| | Playlist 27 | 108 to 111 | | |
| | Playlist 28 | 112 to 115 | | |
| | Playlist 29 | 116 to 119 | | |
| | Playlist 30 | 120 to 123 | | |
| | Playlist 31 | 124 to 127 | | |
| | Playlist 32 | 128 to 131 | | |
| | Playlist 33 | 132 to 135 | | |
| | Playlist 34 | 136 to 139 | | |
| | Playlist 35 | 140 to 143 | | |
| | Playlist 36 | 144 to 147 | | |
| | Playlist 37 | 148 to 151 | | |
| | Playlist 38 | 152 to 155 | | |
| | Playlist 39 | 156 to 159 | | |
| | Playlist 40 | 160 to 163 | | |
| | Playlist 41 | 164 to 167 | | |
| | Playlist 42 | 168 to 171 | | |
| | Playlist 43 | 172 to 175 | | |

| Channel/Functi on | Operation | Parameters | Default value | Description |
|-------------------|-----------------|------------|---------------|--------------------------------------|
| | Playlist 44 | 176 to 179 | | |
| | Playlist 45 | 180 to 183 | | |
| | Playlist 46 | 184 to 187 | | |
| | Playlist 47 | 188 to 191 | | |
| | Playlist 48 | 192 to 195 | | |
| | Playlist 49 | 196 to 199 | | |
| | Playlist 50 | 200 to 203 | | |
| | Non-operational | 204 to 255 | | |
| 11 Power control | Power off | 0 to 63 | 128 | Turns the projector power on or off. |
| | Non-operational | 64 to 191 | | |
| | Power on | 192 to 255 | | |
| 13 Lock | Cannot control | 0 to 127 | 0 | Enables/disables Art-Net operations. |
| | Can control | 128 to 255 | | |



If you are controlling the projector using Art-Net and operating it from the remote control, settings made by the DMX controller or application software may differ from the projector's actual status. If you want to apply all the channel controls to the projector, set Channel 13 to "Cannot control", then set it back to "Can control".

» **Related Links**

- "Network Menu - Others Menu" [p.142](#)

You can schedule up to 30 events to occur automatically on your projector, such as turning the projector on or off or switching the input source. The projector performs the selected events on the specified date and time in the schedule you set up.

Warning

Do not place flammable objects in front of the lens. If you schedule the projector to turn on automatically, flammable objects in front of the lens could catch on a fire.



- If you set a **Schedule Protection** password, turn off your **Schedule Protection** password first.

- 1** Set the date and time in the **Date & Time** menu.
 **Extended > Operation > Date & Time**
- 2** Press the [Menu] button, select the **Extended** menu, and press [Enter].
- 3** Select **Schedule Settings** and press [Enter].
- 4** Select **Schedule** and press [Enter].

- 5** Select **Add New** and press [Enter].

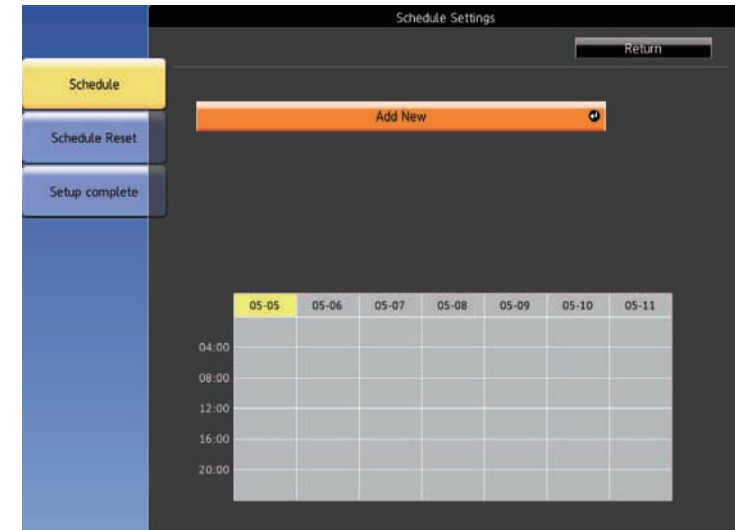

- 6** Select the event details you want to perform.

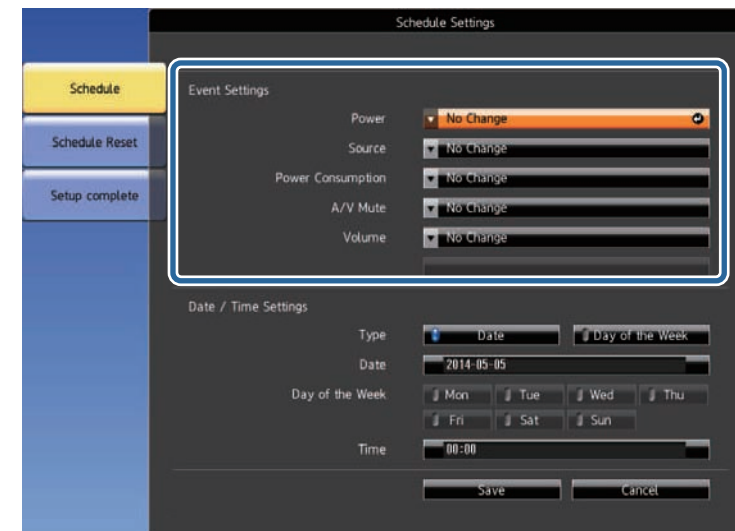

7 Select the date and time at which you want the event to occur.



8 Select **Save** and press [Enter].

The scheduled events are displayed on the screen with icons indicating the event status.



- ① : valid schedule
- : regular schedule
- : invalid schedule
- ② The date currently selected (highlighted in yellow)
- ③ : one time schedule
- : regular schedule
- : standby schedule (turns communication on or off during standby)
- : invalid schedule

9 To edit a scheduled event, select the schedule and press [Esc].

10 Select an option from the menu displayed.

- **On** or **Off** lets you enable or disable the selected event.

- **Edit** lets you change the event details or date and time.
- **Clear** lets you remove the scheduled event from a list.

11 Select **Complete**, then select **Yes**.

To delete all scheduled events, select **Schedule Reset**.

» **Related Links**

- "Setting the Date and Time" [p.35](#)
- "Setting a Password" [p.81](#)

Adjusting the Menu Settings

Follow the instructions in these sections to access the projector menu system and change projector settings.

► Related Links

- "Using the Projector's Menus" [p.126](#)
- "Using the Displayed Keyboard" [p.127](#)
- "Image Quality Settings - Image Menu" [p.128](#)
- "Input Signal Settings - Signal Menu" [p.130](#)
- "Projector Feature Settings - Settings Menu" [p.131](#)
- "Projector Setup Settings - Extended Menu" [p.133](#)
- "Projector Network Settings - Network Menu" [p.136](#)
- "Projector Setup Settings - ECO Menu" [p.144](#)
- "Projector Information Display - Info Menu" [p.146](#)
- "Projector Reset Options - Reset Menu" [p.148](#)
- "Copying Menu Settings Between Projectors (Batch Setup)" [p.149](#)

You can use the projector's menus to adjust the settings that control how your projector works. The projector displays the menus on the screen.

- 1 Press the [Menu] button on the remote control.

You see the menu screen displaying the **Image** menu settings.

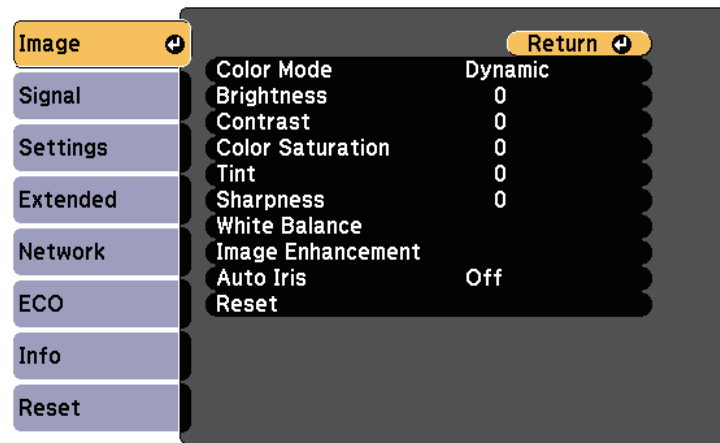

- 2 Press the up or down arrow buttons to move through the menus listed on the left. The settings for each menu are displayed on the right.



The available settings depend on the current input source.

- 3 To change settings in the displayed menu, press [Enter].
- 4 Press the up or down arrow button to move through the settings.
- 5 Change the settings using the buttons listed on the bottom of the menu screens.
- 6 To return all the menu settings to their default values, select **Reset**.

- 7 When you finish changing settings on a menu, press [Esc].

- 8 Press [Menu] or [Esc] to exit the menus.

You can use the displayed keyboard to enter numbers and characters.

- 1 Use the arrow buttons on the remote control to highlight the number or character you want to enter and press the [Enter] button.

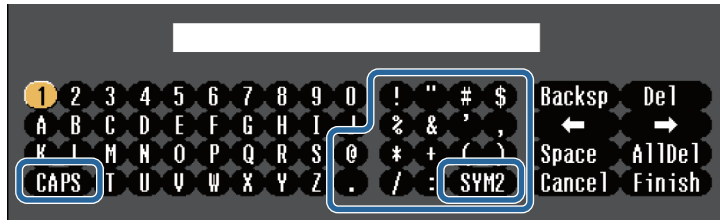

 Each time you select the **CAPS** key, the characters change between upper case and lower case. Each time you select the **SYM1/2** key, the symbols enclosed by the frame change.

- 2 After entering the text, select **Finish** on the keyboard to confirm your entries. Select **Cancel** to cancel entering text.

 You can select projector settings and control projection over a network using a Web browser from your computer.
Some symbols cannot be entered using the displayed keyboard. Use your Web browser to enter the text.

» **Related Links**

- "Available Text Using the Displayed Keyboard" [p.127](#)
- "Controlling a Networked Projector Using a Web Browser" [p.101](#)

| Text type | Details |
|-----------|--|
| Numbers | 0123456789 |
| Alphabet | ABCDEFGHIJKLMNOPQRSTUVWXYZ abcdefghijklmnopqrstuvwxyz |
| Symbols | !"#\$%&'()*+,-./:;<=>?@[\] ^_`{ }~ |

Available Text Using the Displayed Keyboard

You can enter the following text when using the displayed keyboard.

Settings on the **Image** menu let you adjust the quality of your image for the input source you are currently using. The available settings depend on the currently selected input source.

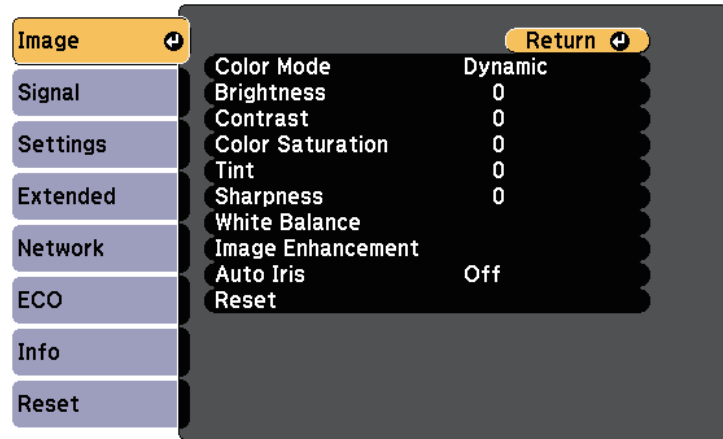

To change settings for an input source, make sure the source is connected and select that source.

| Setting | Options | Description |
|------------------|---------------------------------------|---|
| Color Mode | See the list of available color modes | Adjusts the vividness of image colors for various image types and environments. |
| Brightness | Varying levels available | Lightens or darkens the overall image. |
| Contrast | Varying levels available | Adjusts the difference between light and dark areas of the image. |
| Color Saturation | Varying levels available | Adjusts the intensity of the image colors. |
| Tint | Varying levels available | Adjusts the balance of green to magenta tones in the image. |
| Sharpness | Varying levels available | Adjusts the sharpness or softness of image details. |
| White Balance | | Adjusts the overall tint of the image. |

| Setting | Options | Description |
|-------------------|---|--|
| | Color Temp. | Color Temp.: sets the color temperature according to the color mode you selected. Higher values tint the image blue and lower values tint the image red. |
| | Custom | Custom: adjusts the individual R (red), G (green), and B (blue) components of the offset and gain. |
| Image Enhancement | | Adjusts the perceived resolution of the image: |
| | Noise Reduction | Noise Reduction: reduces flickering in analog images. |
| | Deinterlacing (For interlaced signal [480i/576i/1080i] input) | Deinterlacing: sets whether or not to convert interlaced-to-progressive signals for certain video image types. <ul style="list-style-type: none"> • Off: for fast-moving video images. • Video: for most video images. • Film/Auto: for movies, computer graphics, and animation. |
| Auto Iris | Off Normal High Speed | Adjusts the projected luminance based on the image brightness. Available when the Color Mode is set to Dynamic or Cinema . This setting is disabled when Edge Blending is set to On . 🖱️ Extended > Multi-Projection > Edge Blending |
| Reset | — | Resets all adjustment values on the Image menu for the selected color mode to their default settings. |



 • The **Brightness** setting does not affect lamp brightness. To change the lamp brightness mode, use the **Power Consumption** setting in the projector's **ECO** menu.

» Related Links

- "Available Color Modes" [p.51](#)

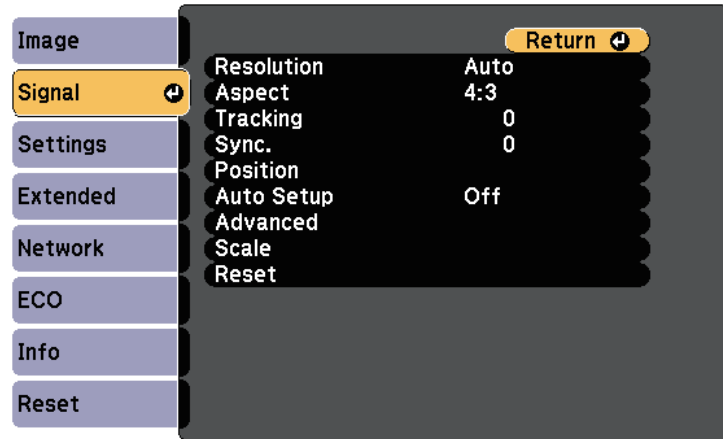
Normally the projector automatically detects and optimizes the input signal settings. If you need to customize the settings, you can use the **Signal** menu. The available settings depend on the currently selected input source.



 You can restore the default settings of the **Tracking**, **Sync.**, and **Position** settings by pressing the [Auto] button on the remote control.

To change settings for an input source, make sure the source is connected and select that source.

| Setting | Options | Description |
|------------|--|--|
| Resolution | Auto Wide Normal | Sets the input signal resolution if not detected automatically using the Auto option. |
| Aspect | See the list of available aspect ratios. | Sets the aspect ratio (width-to-height ratio) for the selected input source. |
| Tracking | Varying levels available | Adjusts the signal to eliminate vertical stripes in computer images. |
| Sync. | Varying levels available | Adjusts the signal to eliminate fuzziness or flickering in computer images. |

| Setting | Options | Description |
|------------|-------------------------|---|
| Position | — | Adjusts the image location on the screen. |
| Auto Setup | On Off | Automatically optimizes computer image quality (when On). |
| Overscan | Auto Off 4% 8% | Changes the projected image ratio to make the edges visible by a selectable percentage or automatically. |
| Advanced | Video Range | Video Range: sets the video range to match the setting of the device connected to the HDMI port. |
| | Input Signal | Input Signal: specifies the signal type from the input sources connected to the computer ports. <ul style="list-style-type: none"> • Auto: detects signals automatically. • RGB: inputs computer/RGB video signals. • Component: inputs component video signals. |
| Scale | Various scale options | When using multiple projectors to project one image, adjusts the scale of the image displayed by each projector. |
| Reset | — | Resets all adjustment values on the Signal menu to their default settings, except for the following: <ul style="list-style-type: none"> • Input Signal |

» **Related Links**

- "Available Image Aspect Ratios" [p.49](#)

Options on the **Settings** menu let you customize various projector features.

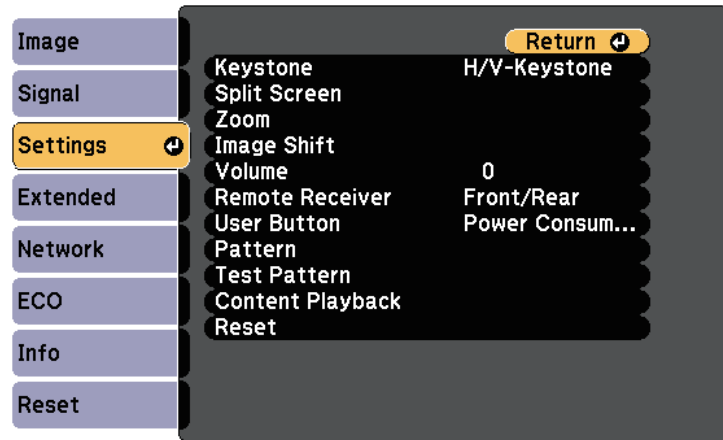

| Setting | Options | Description |
|-------------------|--------------------------|--|
| Keystone | | Adjusts image shape to rectangular (horizontally and vertically). |
| | H/V-Keystone | H/V-Keystone: select to manually correct horizontal and vertical sides, or turn automatic correction on or off. |
| | Quick Corner | Quick Corner: select to correct image shape and alignment using an on-screen display. |
| Split Screen | Screen Size | Divides the viewing area horizontally and displays two images side-by-side (press [Esc] to cancel split screen display). |
| | Source | |
| | Swap Screens | |
| | Audio Source | |
| | Align | |
| | Display the QR Code | |
| Exit Split Screen | | |
| Zoom | Varying levels available | Adjusts the size of the projected image. |

| Setting | Options | Description |
|-----------------|--|---|
| Image Shift | Varying positions available | Adjusts the position of the image without moving the projector. This feature is not available if the Zoom option is set to the widest setting. |
| Volume | Varying levels available | Adjusts the volume of projector's speaker system. You can also adjust the volume of external speakers. Setting values are saved for each source. |
| Remote Receiver | Front/Rear Front Rear Off | Limits reception of remote control signals by the selected receiver; Off turns off all receivers. |
| User Button | Power Consumption Info Deinterlacing Test Pattern Resolution Display the QR Code Spotlight | Assigns a menu option to the [User] button on the remote control for one-touch access. |
| Pattern | | Selects various pattern display options. Attention If a pattern is displayed for a long time, a residual image may be visible in projected images. |
| | Pattern Display | Pattern Display: lets you display the selected pattern type on the screen to aid in presentation. |

| Setting | Options | Description |
|------------------|------------------|---|
| | Pattern Type | Pattern Type: select from Patterns 1 to 4 or User Pattern . Patterns 1 to 4 display patterns pre-registered in the projector, such as ruled lines or grid patterns. |
| | User Pattern | User Pattern: captures a projected screen and saves it as a pattern for display. |
| Test Pattern | — | Displays a test pattern to assist in focusing and zooming the image and correcting image shape (press the [Esc] button to cancel pattern display). |
| Content Playback | Content Playback | Set to On to play back a playlist created by using the Epson Projector Content Manager software. |
| | Overlay Effect | Adds color and shape effects to the projected image. (Available only when Content Playback is set to On .) |
| | USB Viewer | Selects and plays back a playlist saved on the USB flash drive. (Available only when Content Playback is set to On .) |
| Reset | — | Resets all adjustment values on the Settings menu to their default settings, except for the following: <ul style="list-style-type: none"> • Zoom • Image Shift • User Button |

Settings on the **Extended** menu let you customize various projector setup features.

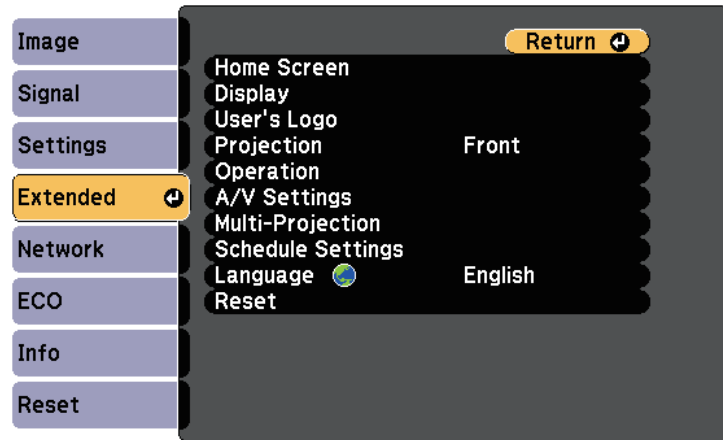

| Setting | Options | Description |
|-------------|--|---|
| Home Screen | | Selects the projector's Home screen display options: |
| | Home Screen Auto Disp. | Home Screen Auto Disp.: select whether or not to display the Home screen automatically when there is no input signal when turning on the projector. |
| | Custom Function 1 Custom Function 2 | Custom Function 1/Custom Function 2: select to set functions and the display as the customized Home screen. |
| Display | | Selects various display options: |
| | Messages | Messages: set to On to display messages such as input source name, color mode name, aspect ratio, no signal message, or high temperature warning on your projected image. Set to Off if you do not want to display messages. |

| Setting | Options | Description |
|-------------|--|---|
| | Display Background | Display Background: sets the screen color or logo to display when no signal is received. |
| | Startup Screen | Startup Screen: set to On to display a logo when the projector starts up. |
| | A/V Mute | A/V Mute: sets the screen color or logo to display when A/V Mute is turned on. |
| | Color Uniformity | Color Uniformity: set to On to adjust the color tone balance for the whole screen. <ul style="list-style-type: none"> • Adjustment Level: set the adjustment level. • Start Adjustments: select the area for which you want to adjust the color tone for red, green, and blue individually. |
| User's Logo | — | Creates a screen that the projector displays to identify itself and enhance security. |
| Projection | Front Front/Ceiling Rear Rear/Ceiling | Selects the way the projector faces the screen so the image is oriented correctly. |
| Operation | | Selects various operation options: |
| | Direct Power On | Direct Power On: lets you turn on the projector by plugging it in without pressing the power button. |
| | High Altitude Mode | High Altitude Mode: regulates the projector's operating temperature at altitudes above 1500 m. |
| | Auto Source Search | Auto Source Search: set to On to detect the input signal automatically and project images when there is no input signal. |

| Setting | Options | Description |
|---------|-----------------|---|
| | Auto Power On | <p>Auto Power On: select the image source from which you want to automatically start projection. When the projector detects the input signal from the selected image source, it projects automatically in standby mode.</p> <p>The following image sources are available for this feature:</p> <ul style="list-style-type: none"> • HDMI1 • Computer1 • USB Display |
| | Startup Source | Select the image source you want to project when the projector is turned on in Content Playback mode. |
| | HDMI EQ Setting | <p>HDMI EQ Setting: Adjust the HDMI input signal level depending on the devices connected to the HDMI port. If there is a lot of interference in the image, or if a problem such as no image being projected occurs, change the setting.</p> <p>If no images are displayed using a thumb-sized media streaming device, select 1.</p> |
| | Advanced | <p>Batch Setup Range: select All to copy all of the projector menu settings using the batch setup feature. Select Limited, if you do not want to copy the following settings:</p> <ul style="list-style-type: none"> • Password Protection settings • Network menu settings |
| | Date & Time | <p>Date & Time: adjusts the projector's system time and date settings.</p> <ul style="list-style-type: none"> • Daylight Saving Time: set to On to activate daylight saving time. • Internet Time: set to On to update the time automatically through an Internet time server. |

| Setting | Options | Description |
|-------------------|---------------------------|--|
| A/V Settings | | Selects various audio and video output settings: |
| | A/V Output | A/V Output: set to Always On to output audio and images to external devices when the projector is in standby mode. |
| | Audio Settings | <p>Audio Output: selects the audio input port when projecting images from anything except for HDMI ports.</p> <p>HDMI1 Audio Output/HDMI2 Audio Output: selects the audio input port when projecting images from HDMI ports.</p> |
| Multi-Projection | | Make settings when projecting from multiple projectors: |
| | Projector ID | Assigns an ID for the projector when you use multiple projectors. |
| | Color Mode | When projecting from multiple projectors, make sure you select Multi-Projection for all of the projectors. |
| | Color Uniformity | Adjusts the color tone balance for the whole screen. |
| | Edge Blending | Corrects a border between multiple images to create a seamless screen. |
| | Scale | Adjusts the scale of the image displayed by each projector. |
| | Power Consumption | Selects the brightness mode of the projector lamp. |
| | Color Matching | Corrects the difference between the tint and brightness of each projected image. |
| | Reset | Resets all adjustment values for the Multi-Projection menu to their default settings. |
| Schedule Settings | To Schedule Settings menu | Schedules projector events to occur automatically at selected dates and times. |

| Setting | Options | Description |
|----------|-----------------------------|--|
| Language | Various languages available | Select the language for projector menu and message displays. |
| Reset | — | Resets all adjustment values on the Extended menu to their default settings, except for the following: <ul style="list-style-type: none"> • User's Logo • Projection • High Altitude Mode • Auto Source Search • HDMI EQ Setting • Date & Time • A/V Output • Projector ID • Color Mode • Color Matching • Schedule Settings • Language |



When you set **User's Logo Protection** to **On** in the **Password Protection** screen, you cannot change settings related to user's logo display (**Display Background**, **Startup Screen**, **A/V Mute** in the **Display** setting). Set **User's Logo Protection** to **Off** first.

» **Related Links**

- "Selecting Password Security Types" [p.82](#)

Settings on the **Network** menu let you view network information and set up the projector for controlling over a network.

When you set **Network Protection** to **On** in the **Password Protection** screen, you cannot change the network settings. Set **Network Protection** to **Off** first.

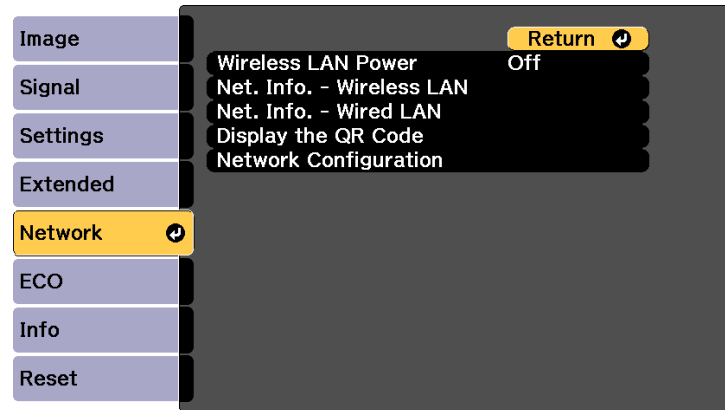

| Setting | Options | Description |
|--------------------|-----------|---|
| Wireless LAN Power | On Off | Configures your wireless LAN settings. Select On to project images via a wireless LAN. If you do not want to connect via wireless LAN, turn it off to prevent unauthorized access by others. |

| Setting | Options | Description |
|---------------------------|---|--|
| Net. Info. - Wireless LAN | Connection Mode Wireless LAN Sys. Antenna Level Projector Name SSID DHCP IP Address Subnet Mask Gateway Address MAC Address Region Code IPv6 | Displays wireless network status and details. Available when you have set Wireless LAN Power to On . The following settings are displayed when you select the IPv6 option. <ul style="list-style-type: none"> • IPv6 Address (Manual) <ul style="list-style-type: none"> • IPv6 Address • Prefix Length • Gateway Address • IPv6 Address (Auto) <ul style="list-style-type: none"> • Temporary Address • Link-local Address • Stateless Address • Stateful Address |
| Net. Info. - Wired LAN | Projector Name DHCP IP Address Subnet Mask Gateway Address MAC Address IPv6 Address (Manual) IPv6 Address (Auto) | Displays wired network status and details. The following settings are displayed when you select the IPv6 Address (Manual) or IPv6 Address (Auto) option. <ul style="list-style-type: none"> • IPv6 Address (Manual) <ul style="list-style-type: none"> • IPv6 Address • Prefix Length • Gateway Address • IPv6 Address (Auto) <ul style="list-style-type: none"> • Temporary Address • Link-local Address • Stateless Address • Stateful Address |
| Display the QR Code | — | Displays a QR code for connecting with iOS or Android devices using the Epson iProjection app. |

| Setting | Options | Description |
|-----------------------|-----------------------------|-----------------------------------|
| Network Configuration | To additional network menus | Configures your network settings. |

 Once you have connected your projector to your network, you can select projector settings and control projection using a compatible Web browser. This allows you to access the projector remotely.

» Related Links

- "Network Menu - Basic Menu" [p.137](#)
- "Network Menu - Wireless LAN Menu" [p.138](#)
- "Network Menu - Wired LAN Menu" [p.140](#)
- "Network Menu - Notifications Menu" [p.141](#)
- "Network Menu - Others Menu" [p.142](#)
- "Network Menu - Reset Menu" [p.143](#)
- "Selecting Password Security Types" [p.82](#)

Network Menu - Basic Menu

Settings on the **Basic** menu let you select the basic network settings.

☛ **Network > Network Configuration > Basic**

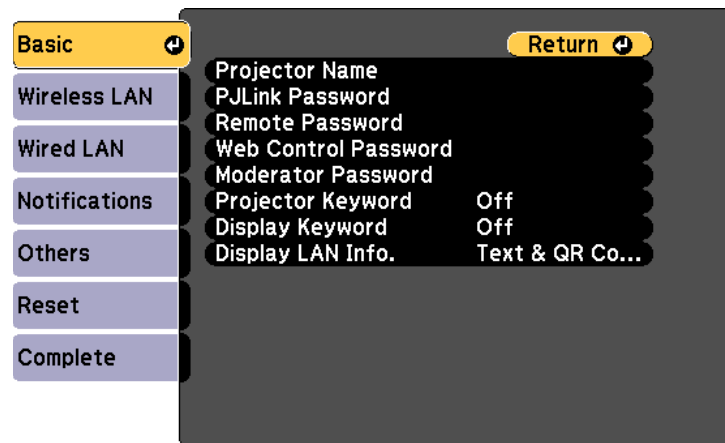

| Setting | Options | Description |
|----------------------|---|---|
| Projector Name | Up to 16 alphanumeric characters (do not use " * + , / ; < = > ? [\] ` spaces) | Enter a name to identify the projector over the network. |
| PJLink Password | Up to 32 alphanumeric characters | Enter a password for using the PJLink protocol for projector control. |
| Remote Password | Up to 8 alphanumeric characters (do not use * : spaces) | Enter a password for accessing the projector using the Basic Control. (User name is EPSONREMOTE ; default password is guest .) |
| Web Control Password | Up to 8 alphanumeric characters (do not use * : spaces) | Enter a password for accessing the projector over the Web. (User name is EPSONWEB ; default password is admin .) |
| Moderator Password | Four-digit number | Enter a password for accessing the projector as a moderator using Epson iProjection. (No password is set by default.) |
| Projector Keyword | On Off | Set to On to enable a security password to prevent access to the projector by anyone not in the same room as the projector. You must enter a displayed, randomized keyword from a computer using Epson iProjection to access the projector and share the current screen. |
| Display Keyword | On Off | Set to On to display a projector keyword on the projected image when accessing the projector using Epson iProjection. Available when Projector Keyword is set to On . |

| Setting | Options | Description |
|-------------------|------------------------|---|
| Display LAN Info. | Text & QR Code Text | Set the display format for the projector's network information. By simply reading the QR code with Epson iProjection, you can connect the mobile device to the projector through a network. The default value is Text & QR Code . |

Network Menu - Wireless LAN Menu

Settings on the **Wireless LAN** menu let you select the wireless LAN settings.

☛ **Network > Network Configuration > Wireless LAN**

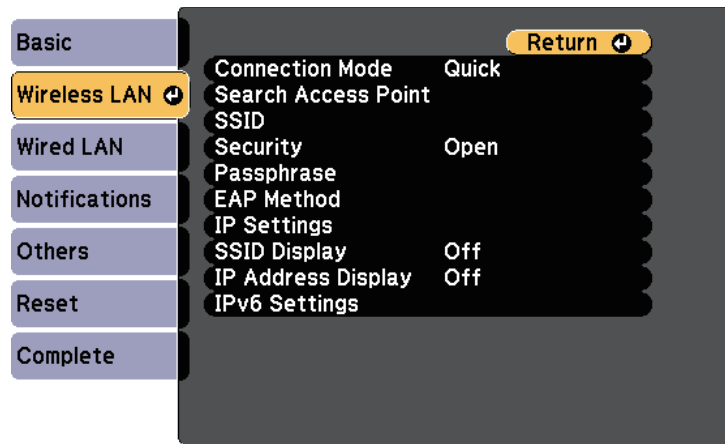

| Setting | Options | Description |
|-----------------|---------|---|
| Connection Mode | | Select the type of wireless connection: |

| Setting | Options | Description |
|---------------------|----------------------------------|---|
| | Quick | Quick: lets you connect to multiple smartphones, tablets, or computers directly using wireless communication. When you select Quick connection mode, the projector acts as an easy access point. (We recommend limiting the number of devices to six or less to maintain the projection performance.) |
| | Advanced | Advanced: lets you connect to multiple smartphones, tablets, or computers over a wireless network access point. |
| Search Access Point | To Search View | Search for available wireless network access points in Advanced connection mode. Depending on the access point settings, they may not be displayed in the list. |
| SSID | Up to 32 alphanumeric characters | Sets the SSID (network name) of the wireless LAN system the projector is connecting to. |
| Security | | Selects the type of security used on the wireless network. When setting security, follow the instructions from the administrator of the network system you want to connect to. |
| | Open | Open: security is not set. |
| | WPA2-PSK | WPA2-PSK: communication is performed using WPA2 security. Uses AES method for encryption. When establishing a connection from a computer to the projector, enter the value set in the passphrase. |
| | WPA/WPA2-PSK | WPA/WPA2-PSK: connects in WPA personal mode. Encryption method is selected automatically according to the access point settings. Set a passphrase which is the same for the access point. |

| Setting | Options | Description |
|------------|--|---|
| | WPA2-EAP WPA/WPA2-EAP | WPA2-EAP or WPA/WPA2-EAP : connects in WPA enterprise mode. Encryption method is selected automatically according to the access point settings. Select this item when using LEAP. |
| Passphrase | Various passphrases from 8 to 32 characters (when entering from a Web browser: various passphrases from 8 to 63 characters) | For WPA2-PSK and WPA/WPA2-PSK security, selects the pre-shared passphrase used on the network. When the passphrase is entered and the [Enter] button is pressed, the value is set and displayed as an asterisk (*). We recommend changing the passphrase periodically for security. If the network settings are initialized, it returns to the initial passphrase. |
| EAP Method | | Set the EAP settings for WPA2-EAP and WPA/WPA2-EAP security. |
| | EAP Type | <p>EAP Type: selects the protocol for authentication.</p> <ul style="list-style-type: none"> • PEAP: authentication protocol widely used in Windows Server. • PEAP-TLS: authentication protocol used in Windows Server. Select this when using a client certificate. • EAP-TLS: authentication protocol widely used to use a client certificate. • EAP-FAST, LEAP: select this when these authentication protocols are used. |

| Setting | Options | Description |
|---------|---------------------|---|
| | User name | User name : enter up to 63 alphanumeric characters. You can enter up to 32 alphanumeric characters in the projector menu. To enter more than 32 characters, use your Web browser. You can enter a domain name by adding it before the user name and separating them with a backslash (domain\username). When importing a client certificate, the name the certificate was issued to is automatically set. |
| | Password | Password : enter a password up to 63 alphanumeric characters for authentication when using the PEAP, EAP-FAST, or LEAP type. You can enter up to 32 alphanumeric characters in the projector menu. To enter more than 32 characters, use your Web browser. After you enter the password and select Set , the password is displayed as an asterisk (*). |
| | Client Certificate | Client Certificate : imports the client certificate when using the PEAP-TLS or EAP-TLS type. |
| | Verify Server Cert. | Verify Server Cert.: selects whether to verify the server certificate when a CA certificate has been set. |
| | CA certificate | CA certificate : imports the CA certificate when using the PEAP, PEAP-TLS, EAP-TLS, or EAP-FAST type. |
| | RADIUS Serv.Name | RADIUS Serv.Name : enter the server name to verify. You can enter up to 32 alphanumeric characters. |
| Channel | 1ch 6ch 11ch | In Quick connection mode, selects the frequency band (channel) used by the wireless LAN. |

| Setting | Options | Description |
|--------------------|--|--|
| IP Settings | DHCP IP Address Subnet Mask Gateway Address | DHCP: set to On if your network assigns addresses automatically; set to Off to manually enter the network's IP Address, Subnet Mask, and Gateway Address using 0 to 255 for each address field. Do not use these addresses: 0.0.0.0, 127.x.x.x, 192.0.2.x or 224.0.0.0 through 255.255.255.255 (where x is a number from 0 to 255) for IP Address, 255.255.255.255 or 0.0.0.0 through 254.255.255.255 for Subnet Mask, and 0.0.0.0, 127.x.x.x or 224.0.0.0 through 255.255.255.255 for Gateway Address. |
| SSID Display | On Off | Select whether to display the SSID on the network standby screen and Home screen. |
| IP Address Display | On Off | Select whether to display the IP address on the network standby screen and Home screen. |
| IPv6 Settings | | Select the IPv6 settings if you want to connect the projector to the network using IPv6: |
| | IPv6 | IPv6: set to On if you want to connect the projector to the network using IPv6. IPv6 is supported to monitor and control the projector over a network using Epson Web Control and PjLink. |
| | Auto Configuration | Auto Configuration: set to On to assign addresses automatically according to the Router Advertisement. |
| | Use Temporary Address | Use Temporary Address: set to On if you want to use a temporary IPv6 address. |

Network Menu - Wired LAN Menu

Settings on the **Wired LAN** menu let you select the wired LAN settings.

☛ **Network > Network Configuration > Wired LAN**

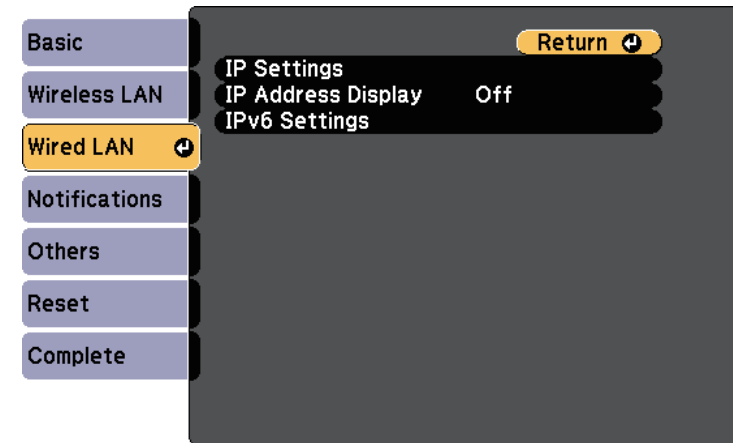

| Setting | Options | Description |
|--------------------|--|--|
| IP Settings | DHCP IP Address Subnet Mask Gateway Address | DHCP: set to On if your network assigns addresses automatically; set to Off to manually enter the network's IP Address, Subnet Mask, and Gateway Address using 0 to 255 for each address field. Do not use these addresses: 0.0.0.0, 127.x.x.x, 192.0.2.x or 224.0.0.0 through 255.255.255.255 (where x is a number from 0 to 255) for IP Address, 255.255.255.255 or 0.0.0.0 through 254.255.255.255 for Subnet Mask, and 0.0.0.0, 127.x.x.x or 224.0.0.0 through 255.255.255.255 for Gateway Address. |
| IP Address Display | On Off | Select whether to display the IP address on the network standby screen. |

| Setting | Options | Description |
|---------------|-----------------------|---|
| IPv6 Settings | | Select the IPv6 settings if you want to connect the projector to the network using IPv6: |
| | IPv6 | IPv6: set to On if you want to connect the projector to the network using IPv6. IPv6 is supported to monitor and control the projector over a network using Epson Web Control and PjLink. |
| | Auto Configuration | Auto Configuration: set to On to assign addresses automatically according to the Router Advertisement. |
| | Use Temporary Address | Use Temporary Address: set to On if you want to use a temporary IPv6 address. |

| Setting | Options | Description |
|---|---|---|
| Mail Notification | On Off | Set to On to send an email to the preset addresses when a problem or warning occurs with a projector. |
| SMTP Server | IP address | Enter the IP address for the projector's SMTP server using 0 to 255 for each address field. Do not use these addresses: 127.x.x.x, 192.0.2.x or 224.0.0.0 through 255.255.255.255 (where x is a number from 0 to 255). |
| Port Number | 0 to 65535 (default is 25) | Select a number for the SMTP server Port Number. |
| From | Up to 32 alphanumeric characters | Enter the email address of the sender. |
| Address 1 Setting Address 2 Setting Address 3 Setting | Up to 64 alphanumeric characters from the Web browser (do not use " () , ; < > [\] spaces) | Enter the e-mail address, and select the alerts you want to receive. Repeat for up to 3 addresses. |
| SNMP | On Off | Set to On to monitor the projector using SNMP. To monitor the projector, you need to install the SNMP manager program on your computer. SNMP should be managed by a network administrator. |
| Trap IP Address 1 Trap IP Address 2 | IP address | Enter up to two IP addresses to receive SNMP notifications, using 0 to 255 for each address field. Do not use these addresses: 127.x.x.x or 224.0.0.0 through 255.255.255.255 (where x is a number from 0 to 255). |

Network Menu - Notifications Menu

Settings on the **Notifications** menu let you receive an email notification if a problem or warning occurs in the projector.

☛ **Network > Network Configuration > Notifications**

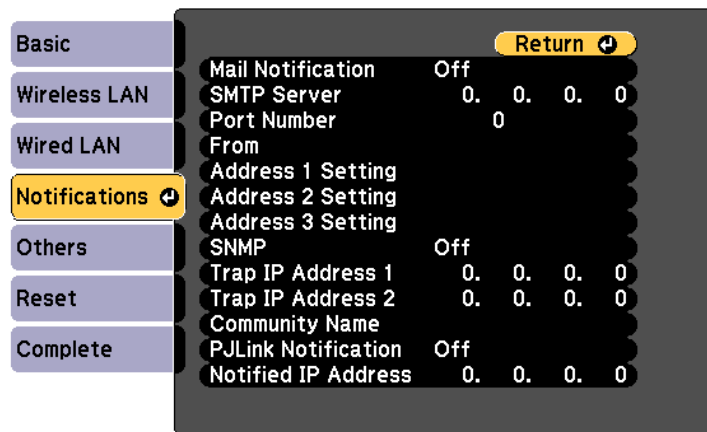

| Setting | Options | Description |
|---------------------|--|--|
| Community Name | Up to 32 alphanumeric characters (do not use spaces and any symbols other than @) | Set the SNMP community name. |
| PJLink Notification | On Off | Enables or disables the PJLink notification function. |
| Notified IP Address | IP address | Enter the IP address to receive the projector's operating status when the PJLink notification function is enabled. Enter the addresses using 0 to 255 for each address field. Do not use these addresses: 127.x.x.x or 224.0.0.0 through 255.255.255.255 (where x is a number from 0 to 255). |

| Setting | Options | Description |
|----------------------|----------------------------|---|
| Secure HTTP | On Off | To strengthen security, communication between the projector and computer in Web control is encrypted. When setting security with Web control, it is recommended to set this to On . |
| Web Server Cert. | — | Imports the Web server certificate for secure HTTP. |
| Priority Gateway | Wired LAN Wireless LAN | You can set the priority gateway. |
| AMX Device Discovery | On Off | Set to On when you want to allow the projector to be detected by AMX Device Discovery. |
| Crestron Connected | On Off | Set to On only when monitoring or controlling the projector over the network using Crestron Connected. Enabling Crestron Connected disables the Epson Message Broadcasting feature in the Epson Projector Management software. |
| Art-Net | Art-Net | Set this to On to control the projector using Art-Net. |
| | Net Sub-Net Universe | Sets the projector's Net, Sub-Net, and Universe. |
| | Start Channel | Sets the start channel that handles Art-Net. |
| Message Broadcasting | On Off | Set to On to receive the message delivered by Epson Projector Management. See the <i>Epson Projector Management Operation Guide</i> for details. Available only when Crestron Connected is set to Off . |

Network Menu - Others Menu

Settings on the **Others** menu let you select other network settings.

☛ Network > Network Configuration > Others

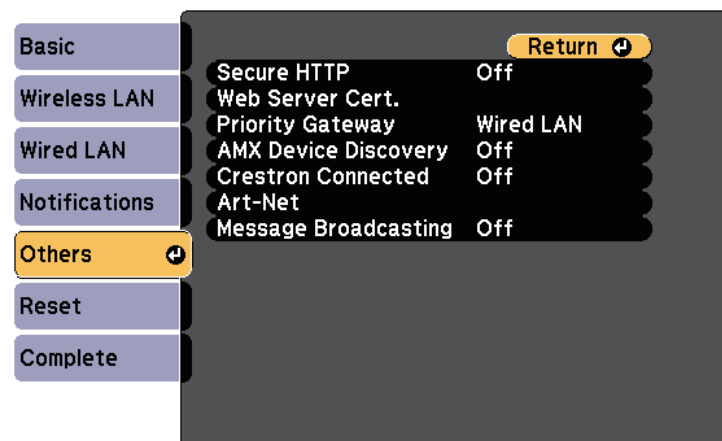

» Related Links

- "Crestron Connected Support" [p.115](#)

Network Menu - Reset Menu

Settings on the **Reset** menu let you reset all of the network settings.

☛ **Network > Network Configuration > Reset**

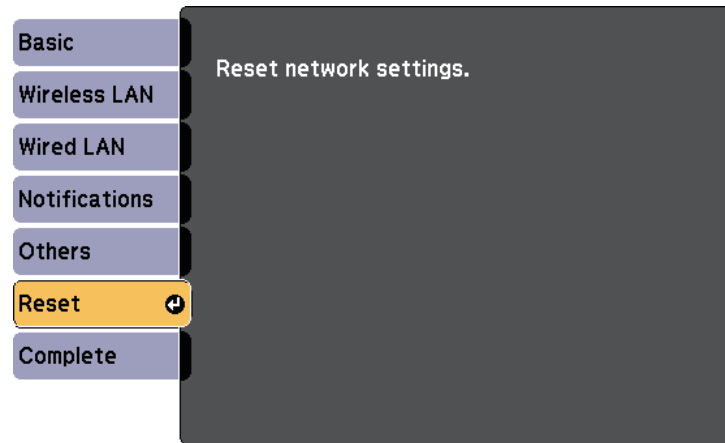

| Setting | Options | Description |
|-------------------------|-----------|--|
| Reset network settings. | Yes No | Select Yes to reset all network settings. |

Settings on the **ECO** menu let you customize projector functions to save power.

When you select a power-saving setting, a leaf icon appears next to the menu item.

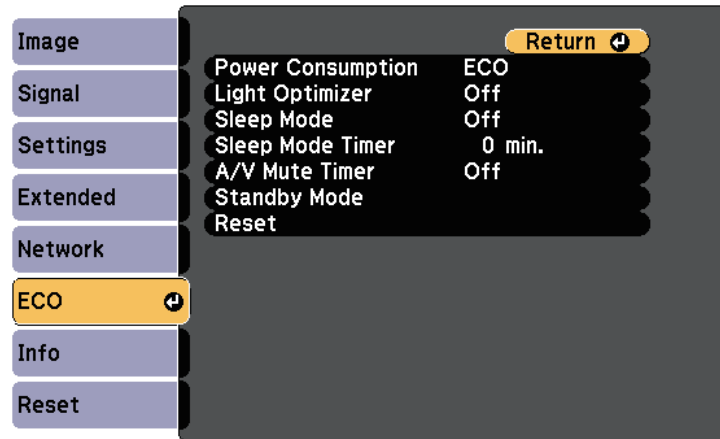

| Setting | Options | Description |
|-------------------|---------|--|
| Power Consumption | | Selects the brightness mode of the projector lamp. You cannot select settings when you use your projector at high altitude or in locations subject to high temperatures. |
| | Normal | Normal: sets maximum lamp brightness. |
| | ECO | ECO: reduces lamp brightness and fan noise, and saves power and lamp life. |

| Setting | Options | Description | | | | | | |
|------------------|---|--|---------|-------------|--------------|---|------|--|
| Light Optimizer | On Off | When set to On , the lamp brightness is adjusted according to the projected image. This helps to reduce the power consumption by lowering the lamp brightness according to the scene being projected. The setting is stored for each Color Mode. This item is enabled when: <ul style="list-style-type: none"> • Power Consumption is set to Normal. | | | | | | |
| Sleep Mode | On Off | Automatically turns off the projector after an interval of inactivity (when On). | | | | | | |
| Sleep Mode Timer | 1 to 30 minutes | Sets the interval for Sleep Mode. | | | | | | |
| A/V Mute Timer | On Off | Automatically turns off the projector after 30 minutes if A/V Mute is enabled (when On). | | | | | | |
| Standby Mode | | Available when you have set A/V Output to While Projecting . <table border="1" data-bbox="1406 919 2101 1476"> <thead> <tr> <th>Options</th> <th>Description</th> </tr> </thead> <tbody> <tr> <td>Standby Mode</td> <td>Communication On indicates that the projector can be monitored over a network when the projector is in standby mode. Enable this setting to allow the following operations to occur when the projector is in standby mode: <ul style="list-style-type: none"> • Monitor and control the projector over a network Communication On is automatically selected when A/V Output is set to Always On. 📁 Extended > A/V Settings > A/V Output </td> </tr> <tr> <td>Port</td> <td>Selects the port to use from Wired LAN or Wireless LAN while the Standby Mode setting is set to Communication On.</td> </tr> </tbody> </table> | Options | Description | Standby Mode | Communication On indicates that the projector can be monitored over a network when the projector is in standby mode. Enable this setting to allow the following operations to occur when the projector is in standby mode: <ul style="list-style-type: none"> • Monitor and control the projector over a network Communication On is automatically selected when A/V Output is set to Always On . 📁 Extended > A/V Settings > A/V Output | Port | Selects the port to use from Wired LAN or Wireless LAN while the Standby Mode setting is set to Communication On . |
| Options | Description | | | | | | | |
| Standby Mode | Communication On indicates that the projector can be monitored over a network when the projector is in standby mode. Enable this setting to allow the following operations to occur when the projector is in standby mode: <ul style="list-style-type: none"> • Monitor and control the projector over a network Communication On is automatically selected when A/V Output is set to Always On . 📁 Extended > A/V Settings > A/V Output | | | | | | | |
| Port | Selects the port to use from Wired LAN or Wireless LAN while the Standby Mode setting is set to Communication On . | | | | | | | |

| Setting | Options | Description |
|---------|---------|---|
| Reset | — | Resets all adjustment values on the ECO menu to their default settings, except for Standby Mode . |



- When the **Sleep Mode Timer** setting is enabled, the lamp dims for a short time before the timer limit is reached and the projector turns off.
- When the **A/V Mute Timer** setting is enabled, the lamp uses less power when **A/V Mute** is activated.

» Related Links

- "Projector Setup Settings - Extended Menu" [p.133](#)

You can display information about the projector and version by viewing the **Info** menu. However, you cannot change any settings in the menu.

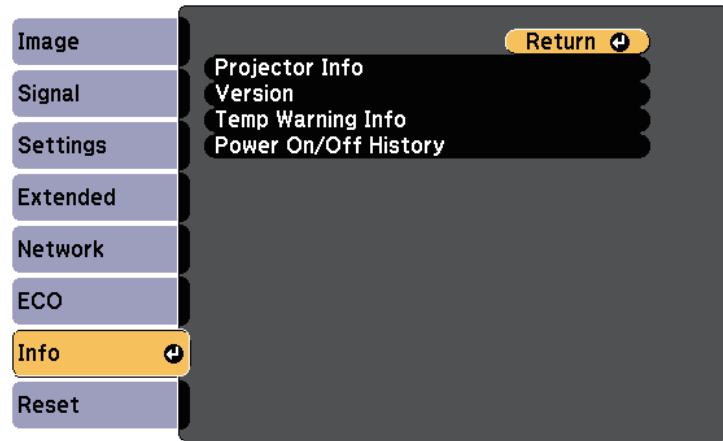

| Information item | Description |
|----------------------|--|
| Projector Info | Displays the projector information. |
| Version | Displays the projector's firmware version. |
| Temp Warning Info | Displays various high temperature warnings. |
| Power On/Off History | Displays the projector's power on and power off history. |

» **Related Links**

- "Info Menu - Projector Info Menu" [p.146](#)

Info Menu - Projector Info Menu

You can display information about the projector and input sources by viewing the **Projector Info** menu in the projector's **Info** menu.

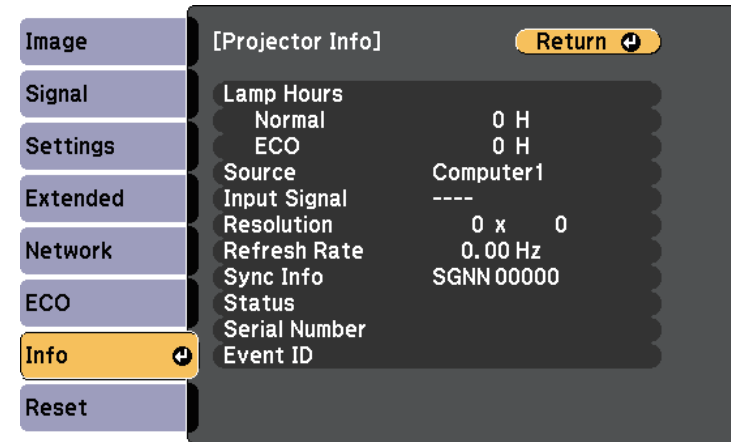

 The available settings depend on the current input source. The lamp usage timer does not register any hours until you have used the lamp for at least 10 hours.

| Information item | Description |
|------------------|--|
| Lamp Hours | Displays the number of hours (H) the lamp has been used in Normal and ECO Power Consumption modes; if the information is displayed in yellow, obtain a genuine Epson replacement lamp soon. |
| Source | Displays the name of the port to which the current input source is connected. |
| Input Signal | Displays the input signal setting of the current input source. |
| Resolution | Displays the resolution of the current input source. |

| Information item | Description |
|------------------|--|
| Refresh Rate | Displays the refresh rate of the current input source. |
| Sync Info | Displays information that may be needed by a service technician. |
| Status | Displays information about projector problems that may be needed by a service technician. |
| Serial Number | Displays the projector's serial number. |
| Event ID | Displays the Event ID number corresponding to a network problem; see the list of Event ID codes. |

► **Related Links**

- "Event ID Code List" [p.147](#)

Event ID Code List

If the **Event ID** option on the **Projector Info** menu displays a code number, check this list of Event ID codes for the solution to the projector problem associated with the code.

If you cannot resolve the problem, contact your network administrator or Epson for technical support.

| Event ID code | Cause and solution |
|------------------------------|--|
| 0432 0435 | The network software did not start. Turn the projector off and then on again. |
| 0433 | Cannot display the transferred images. Restart the network software. |
| 0434 0481 0482 0485 | Unstable network communication. Check the network communication status, wait a few moments, and try connecting to the network again. |
| 0483 04FE | The network software quit unexpectedly. Check the network communication status, then turn the projector off and then on again. |
| 0484 | Communication with computer was disconnected. Restart the network software. |

| Event ID code | Cause and solution |
|---------------|---|
| 0479 04FF | A projector system error has occurred. Turn the projector off and then on again. |
| 0891 | Cannot find an access point with the same SSID. Set your computer, access point, and projector to the same SSID. |
| 0892 | The WPA/WPA2 authentication type does not match. Make sure the wireless network security settings are correct. |
| 0893 | The WEP/TKIP/AES encryption type does not match. Make sure the wireless network security settings are correct. |
| 0894 | Communication with an unauthorized access point was disconnected. Contact your network administrator. |
| 0898 | Failed to acquire DHCP. Make sure the DHCP server is operating correctly. If you are not using DHCP, set the DHCP setting to Off in the projector's Network menu. 🖱️ Network > Network Configuration > Wireless LAN > IP Settings > DHCP 🖱️ Network > Network Configuration > Wired LAN > IP Settings > DHCP |
| 0899 | Other communication errors. |
| 089A | The EAP authentication type does not match the network. Check the wireless LAN security settings and make sure that the security certificate is installed correctly. |
| 089B | EAP server authentication failed. Check the wireless LAN security settings and make sure that the security certificate is installed correctly. |
| 089C | EAP client authentication failed. Check the wireless LAN security settings and make sure that the security certificate is installed correctly. |
| 089D | Key exchange failed. Check the wireless LAN security settings and make sure that the security certificate is installed correctly. |

You can reset most of the projector settings to their default values using the **Reset** menu.

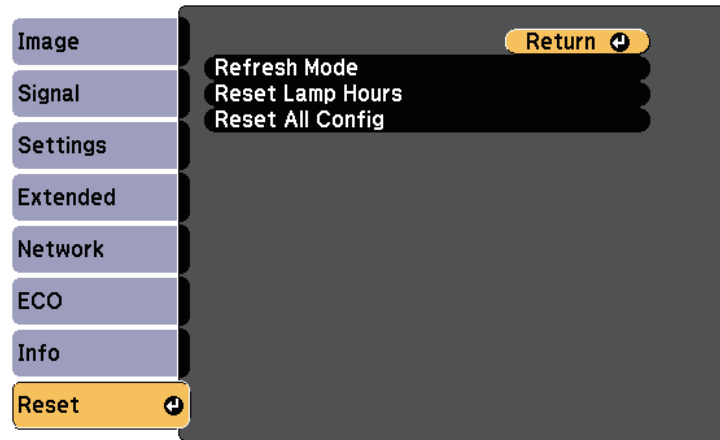

- User's Logo
- Display Background *
- Startup Screen *
- A/V Mute *
- Color Uniformity
- Color Matching
- Schedule Settings
- Language
- Date & Time
- Network menu items
- Lamp Hours
- Password

* Only when you set the **User's Logo Protection** setting to **On** in the **Password Protection** setting menu.

| Setting | Options | Description |
|------------------|----------------------------|---|
| Refresh Mode | Timer Messages Start | Select Start to clear an afterimage that remains in the projected image and turn off the projector after the time specified in Timer . Press any button on the remote control to cancel Refresh Mode. Select On in Messages , if you want to display a message when the Refresh Mode is in progress. |
| Reset Lamp Hours | — | Reset the projector's lamp usage timer to zero when you replace the lamp. |
| Reset All Config | — | Resets most of the projector settings to their default values. |

You cannot reset the following settings using the **Reset All Config** option:

- Input Signal
- Zoom
- Image Shift

After selecting the projector's menu settings for one projector, you can use the following methods to copy the settings to other projectors, as long as they are the same model.

- by using a USB flash drive
- by connecting a computer and projector using a USB cable
- by using Epson Projector Management

Menu settings such as the following are not copied to the other projector.

- **Network** menu settings (except for the **Notifications** menu and the **Others** menu)
- **Lamp Hours** and **Status** from the **Projector Info** menu



- Perform batch setup before adjusting the image settings such as keystone distortion correction. Since image adjustment values are also copied to another projector, the adjustments you made before performing the batch setup are overwritten and the projected screen you adjusted may change.
- When copying the menu settings from one projector to another, user's logo is also copied. Do not register the information that you do not want to share between multiple projectors as a user's logo.

Caution

Epson takes no responsibility for batch setup failures and associated repair costs due to power outages, communication errors, or other problems that may cause such failures.

» Related Links

- "Transferring Settings From a USB Flash Drive" [p.149](#)
- "Transferring Settings From a Computer" [p.150](#)

Transferring Settings From a USB Flash Drive

You can copy menu settings from one projector to another of the same model using a USB flash drive.



The USB flash drive must use a FAT format and not incorporate any security function. Delete any files on the drive before using it for batch setup or the settings may not be saved correctly.

- 1** Disconnect the power cord from the projector, and check that all of the projector's indicators have turned off.
- 2** Connect an empty USB flash drive directly to the projector's USB-A port.
- 3** Hold down the [Esc] button on the remote control and connect the power cord to the projector.
- 4** When all of the projector's indicators turn on, release the [Esc] button. The indicators start flashing and the batch setup file is written to the USB flash drive. When writing is finished, the projector turns off.

Caution

Do not disconnect the power cord or the USB flash drive from the projector while the file is being written. If the power cord or USB flash drive is disconnected, the projector may not start correctly.

- 5** Remove the USB flash drive.



The file name for the batch setup file is PJCONFDATA.bin. If you need to change the file name, add text after PJCONFDATA using only alphanumeric characters. If you change the PJCONFDATA section of the file name, the projector may not be able to recognize the file correctly.

- 6** Disconnect the power cord from the projector to which you want to copy settings, and check that all of the projector's indicators have turned off.

7 Connect the USB flash drive containing the saved batch setup file to the projector's USB-A port.

8 Hold down the [Menu] button on the remote control and connect the power cord to the projector.

9 When all of the projector's indicators turn on, release the [Menu] button.

When all of the indicators start flashing, the settings are being written. When writing is finished, the projector turns off.

Caution

Do not disconnect the power cord or the USB flash drive from the projector while the file is being written. If the power cord or USB flash drive is disconnected, the projector may not start correctly.

10 Remove the USB flash drive.

Transferring Settings From a Computer

You can copy menu settings from one projector to another of the same model by connecting the computer and projector with a USB cable.



You can use this batch setup method with the following operating system versions:

- Windows Vista and later
- OS X 10.7.x and later

1 Disconnect the power cord from the projector, and check that all of the projector's indicators have turned off.

2 Connect a USB cable to the computer's USB port and to the projector's USB-B port.

3 Hold down the [Esc] button on the remote control and connect the power cord to the projector.

4 When all of the projector's indicators turn on, release the [Esc] button. The computer recognizes the projector as a removable disk.

5 Open the removable disk icon or folder, and save the batch setup file to the computer.



The file name for the batch setup file is PJCONFDATA.bin. If you need to change the file name, add text after PJCONFDATA using only alphanumeric characters. If you change the PJCONFDATA section of the file name, the projector may not be able to recognize the file correctly.

6 Eject the USB device (Windows) or drag the removable disk icon to the Trash (Mac).

7 Disconnect the USB cable. The projector turns off.

8 Disconnect the power cord from the projector to which you want to copy settings, and check that all of the projector's indicators have turned off.

9 Connect the USB cable to the computer's USB port and to the projector's USB-B port.

10 Hold down the [Menu] button on the remote control and connect the power cord to the projector.

11 When all of the projector's indicators turn on, release the [Menu] button.

The computer recognizes the projector as a removable disk.

12 Copy the batch setup file (PJCONFDATA.bin) that you saved to your computer to the top level folder of the removable disk.

 Do not copy any files or folders other than the batch setup file to the removable disk.

13 Eject the USB device (Windows) or drag the removable disk icon to the Trash (Mac).

14 Disconnect the USB cable.
When all of the indicators start flashing, the settings are being written. When writing is finished, the projector turns off.

 **Caution**
Do not disconnect the power cord from the projector while the file is being written. If the power cord is disconnected, the projector may not start correctly.

» **Related Links**

- "Batch Setup Error Notification" [p.151](#)

Batch Setup Error Notification

The projector's indicators notify you if an error occurs during a batch setup operation. Check the status of the projector's indicators and follow the instructions described in the table here.

| Indicator status | Problem and solutions |
|--|---|
| <ul style="list-style-type: none"> • Lamp: Orange - flashing fast • Temp: Orange - flashing fast | <p>The batch setup file may be corrupt, or the USB flash drive or USB cable may not be connected correctly.</p> <p>Disconnect the USB flash drive or the USB cable, unplug and then plug in the projector's power cord, and then try again.</p> |

| Indicator status | Problem and solutions |
|---|--|
| <ul style="list-style-type: none"> • Power: Blue - flashing fast • Status: Blue - flashing fast • Lamp: Orange - flashing fast • Temp: Orange - flashing fast | <p>Writing the settings may have failed and an error may have occurred in the projector's firmware.</p> <p>Stop using the projector, remove the power plug from the electrical outlet. Contact Epson for help.</p> |

» **Related Links**

- "Projector Indicator Status" [p.166](#)

Maintaining the Projector

Follow the instructions in these sections to maintain your projector.

► **Related Links**

- "Projector Maintenance" [p.153](#)
- "Cleaning the Lens" [p.154](#)
- "Cleaning the Projector Case" [p.155](#)
- "Air Filter and Vent Maintenance" [p.156](#)
- "Projector Lamp Maintenance" [p.160](#)

You may need to clean the projector's lens periodically, and clean the air filter and air vents to prevent the projector from overheating due to blocked ventilation.

The only parts you should replace are the lamp, air filter, and remote control batteries. If any other part needs replacing, contact Epson or an authorized Epson servicer.

 **Warning**

Before cleaning any part of the projector, turn it off and unplug the power cord. Never open any cover on the projector, except as specifically explained in this manual. Dangerous electrical voltages in the projector can injure you severely.

Clean the projector's lens periodically, or whenever you notice dust or smudges on the surface.

- To remove dust or smudges, gently wipe the lens with lens-cleaning paper.
- To remove stubborn smudges, moisten a soft, lint-free cloth with lens cleaner and gently wipe the lens. Do not spray any liquid directly on the lens.

Warning

Do not use a lens cleaner that contains flammable gas. The high heat generated by the projector lamp may cause a fire.

Attention

Do not use glass cleaner or any harsh materials to clean the lens and do not subject the lens to any impacts; otherwise, it could be damaged. Do not use canned air, or the gases may leave a flammable residue.

Before cleaning the projector case, turn off the projector and unplug the power cord.

- To remove dust or dirt, use a soft, dry, lint-free cloth.
- To remove stubborn dirt, use a soft cloth moistened with water and mild soap. Do not spray liquid directly on the projector.

Attention

Do not use wax, alcohol, benzene, paint thinner, or other chemicals to clean the projector case. These can damage the case. Do not use canned air, or the gases may leave a flammable residue.

Regular filter maintenance is important to maintaining your projector. Clean the air filter when a message appears telling you the temperature inside the projector has reached a high level. It is recommended that you clean these parts over a 10,000-hour period. Clean them more often than this if you use the projector in a particularly dusty environment.

Attention

If regular maintenance is not performed, your Epson projector will notify you when the temperature inside the projector has reached a high level. Do not wait until this warning appears to maintain your projector filter as prolonged exposure to high temperatures may reduce the life of your projector or lamp.

► Related Links

- "Cleaning the Air Filter and Vents" [p.156](#)
- "Replacing the Air Filter" [p.158](#)

Cleaning the Air Filter and Vents

Clean the projector's air filter or vents if they get dusty, or if you see a message telling you to clean them.

- 1** Turn off the projector and unplug the power cord.
- 2** Gently remove the dust from the air intake vent using a small vacuum designed for computers or a very soft brush (such as a paintbrush).

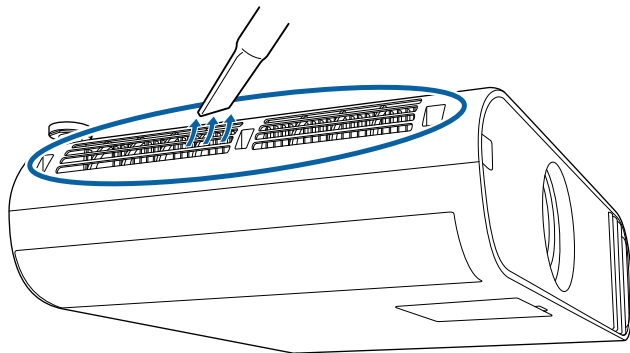

- 3** Open the air filter cover.

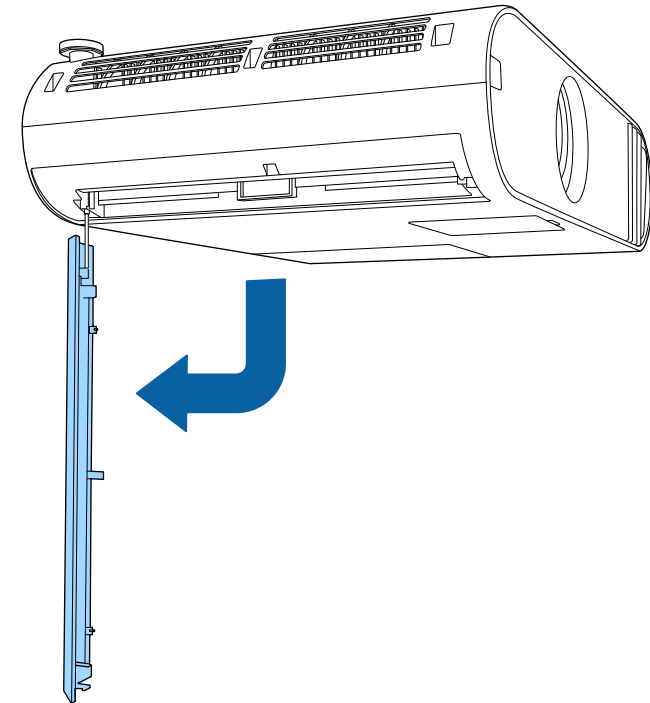

4 Pull the air filter out of the projector.

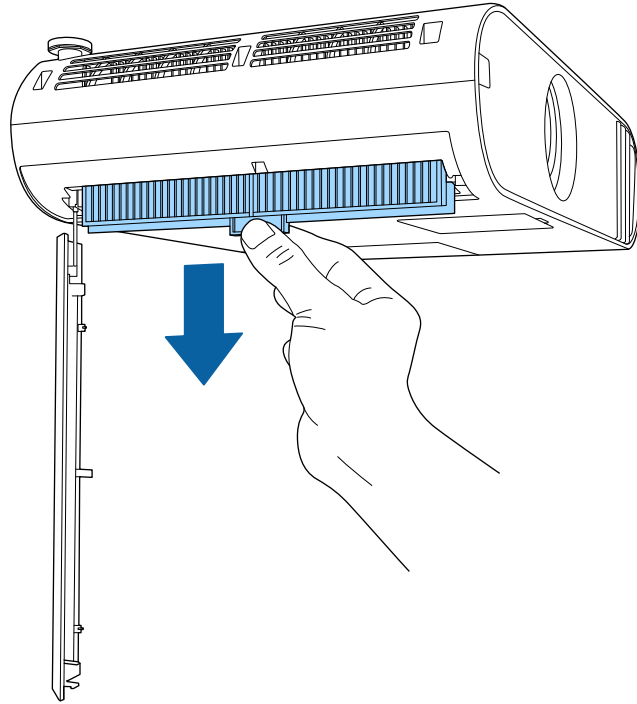

5 Vacuum both sides of the air filter to remove any remaining dust.

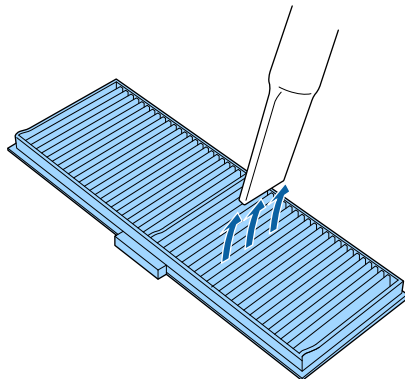

6 Place the air filter so that the runners on both sides of the filter follow the guide grooves on the projector, and push it up gently until it is in a position from which it does not fall down.

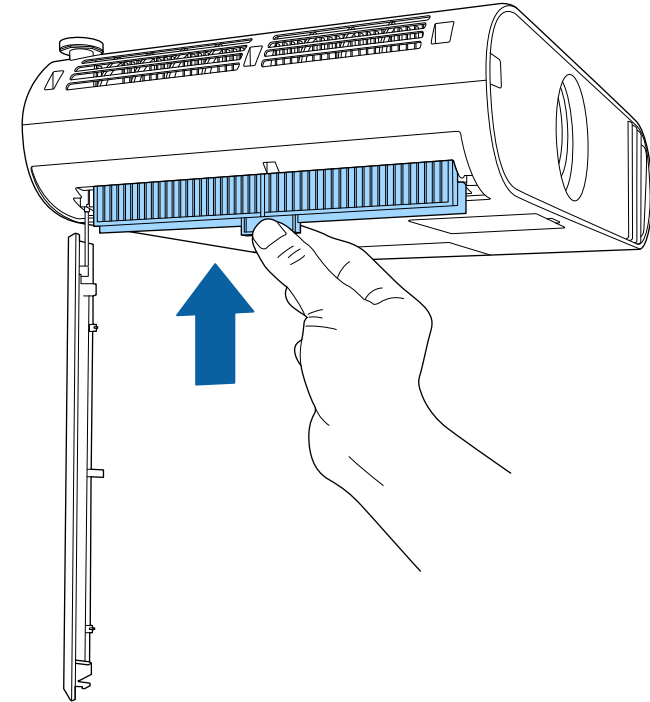

- Do not rinse the air filter in water, or use any detergent or solvent to clean it.
- If dust is difficult to remove or the air filter is damaged, replace the air filter.

Attention

Do not use canned air. The gases may leave a flammable residue or push dust and debris into the projector's optics or other sensitive areas.

Replacing the Air Filter

You need to replace the air filter in the following situations:

- After cleaning the air filter, you see a message telling you to clean or replace it.
- The air filter is torn or damaged.

You can replace the air filter while the projector is mounted to the ceiling or placed on a table.

1 Turn off the projector and unplug the power cord.

2 Open the air filter cover.

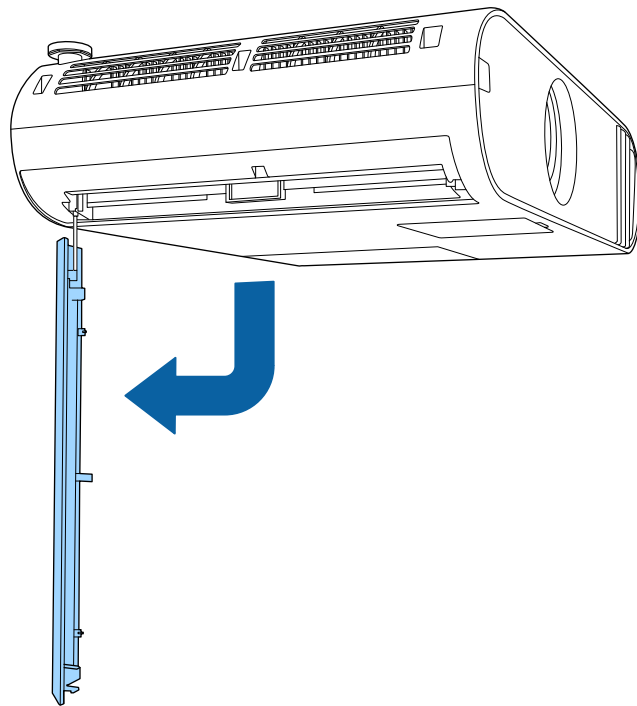

3 Pull the air filter out of the projector.

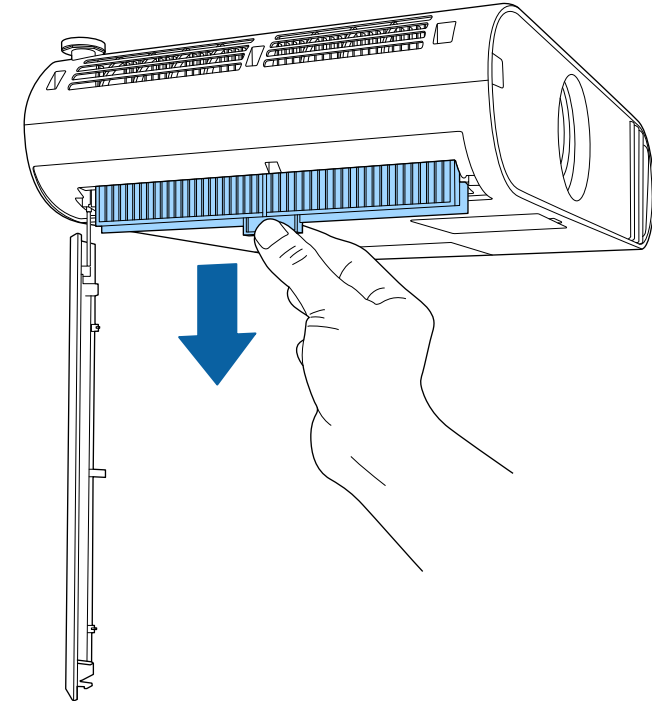

Dispose of used air filters according to local regulations.

- Filter frame: Polypropylene
- Filter: Polypropylene, PET

- 4 Place the new air filter so that the runners on both sides of the filter follow the guide grooves on the projector, and push it up gently until it is in a position from which it does not fall down.

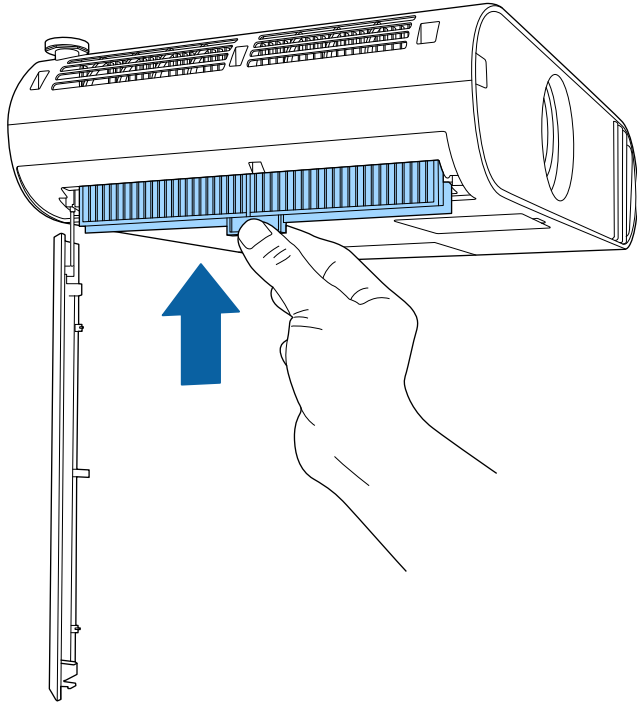

- 5 Close the air filter cover.

» Related Links

- "Replacement Parts" [p.183](#)

The projector monitors the number of hours the lamp is used and displays this information in the projector's menu system.

Replace the lamp as soon as possible when the following occurs:

- The projected image gets darker or quality declines
- A message is displayed when you turn on the projector telling you to replace the lamp (the message is displayed 100 hours before the expected end of the lamp life and appears for 30 seconds)

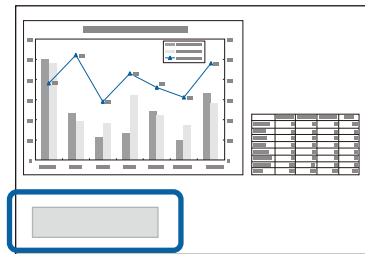

- The projector's power indicator is flashing blue and its lamp indicator is flashing orange.

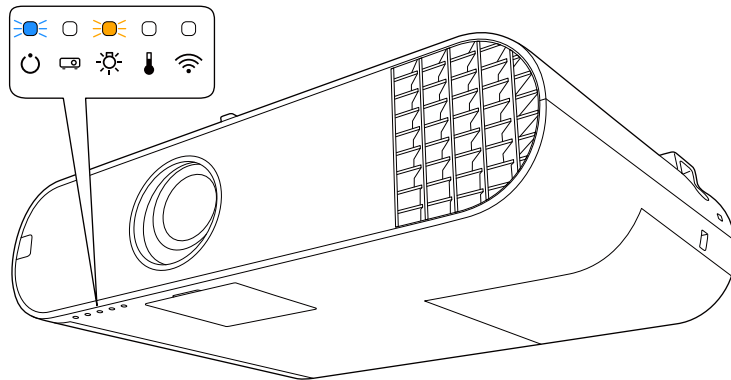

Attention

- If you continue to use the lamp after the replacement period has passed, the possibility that the lamp may explode increases. When the lamp replacement message appears, replace the lamp with a new one as soon as possible, even if it is still working.
- Do not repeatedly turn off the power and then immediately turn it back on. Turning the power on and off frequently may shorten the lamp's operating life.
- Depending on the characteristics of the lamp and the way it has been used, the lamp may become darker or stop working before the lamp warning message appears. You should always have a spare lamp unit ready in case it is needed.
- We recommend the use of genuine Epson replacement lamps. The use of non-genuine lamps may affect projection quality and safety. Any damage or malfunction caused by the use of non-genuine lamps may not be covered by Epson's warranty.

» Related Links

- "Replacing the Lamp" [p.160](#)
- "Resetting the Lamp Timer" [p.162](#)
- "Projector Specifications" [p.189](#)

Replacing the Lamp

You can replace the lamp while the projector is placed on a table or mounted to the ceiling.

⚠ Warning

- Let the lamp fully cool before replacing it to avoid injury.
- Never disassemble or modify the lamp. If a modified or disassembled lamp is installed in the projector, it could cause a fire, electric shock, or other damage or injury.

- 1** Turn off the projector and unplug the power cord.
- 2** Allow the projector lamp to cool down for at least one hour.

- 3** Use the screwdriver included with the replacement lamp to loosen the screw securing the lamp cover.

Warning

When replacing the lamp, there is a possibility that the lamp may be broken. If replacing the lamp of a projector which has been installed on the ceiling, you should always assume that the lamp is cracked, and you should stand to the side of the lamp cover, not underneath it. Remove the lamp cover gently. Be careful when removing the lamp cover as shards of glass may fall out and could cause an injury. If any shards of glass get into your eyes or mouth, contact a doctor immediately.

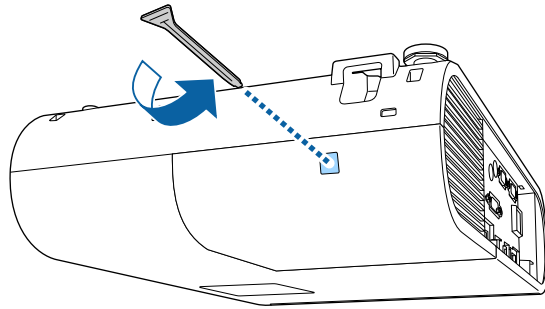

- 4** Slide the lamp cover out and lift it off.

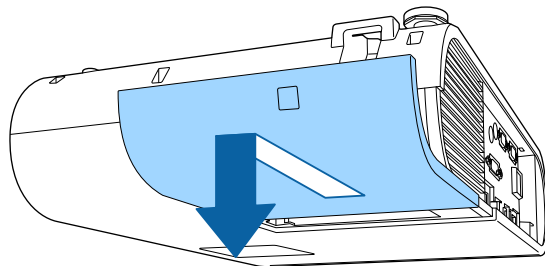

- 5** Loosen the screws securing the lamp to the projector. The screws do not come all the way out.

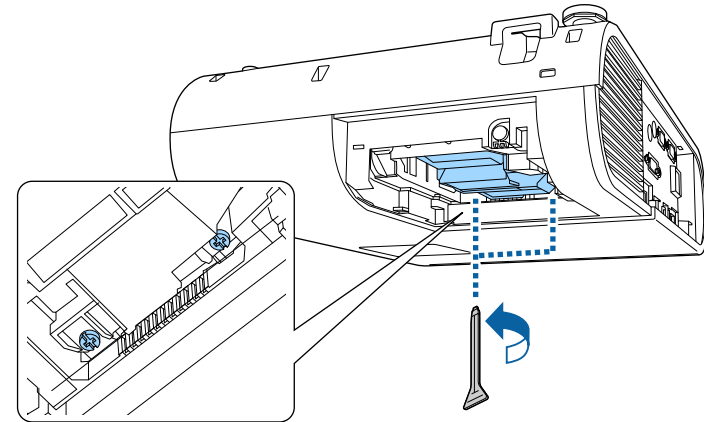

- 6** Grip the raised section of the lamp and remove it.

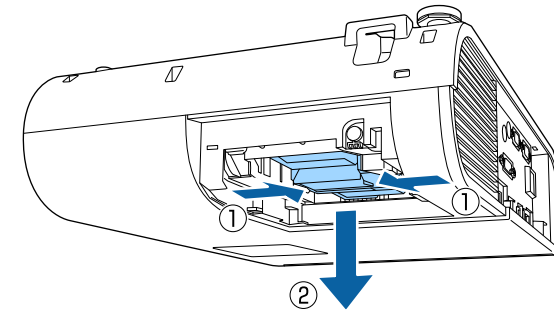

- If you notice the lamp is cracked when removing the lamp, contact Epson for help.
- The lamp(s) in this product contain mercury (Hg). Check your local laws and regulations regarding disposal or recycling. Do not put in the trash.

- 7** Gently insert the new lamp into the projector. If it does not fit easily, make sure it is facing the right way.

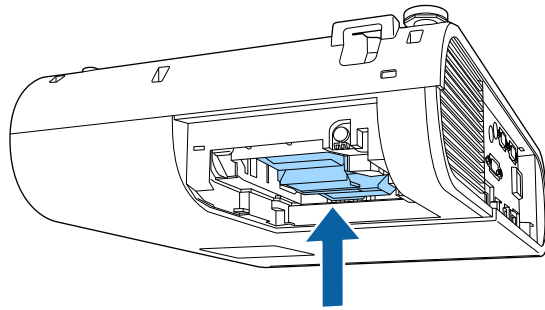

Attention

Do not touch any glass on the lamp assembly to avoid premature lamp failure.

- 8** Push in the lamp firmly and tighten the screws to secure it.

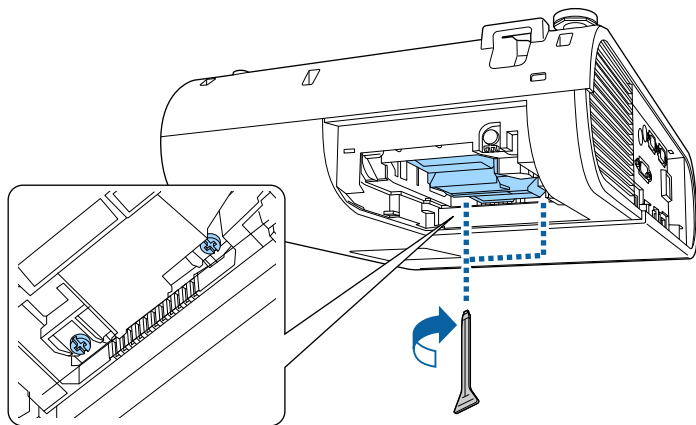

- 9** Replace the lamp cover and tighten the screw to secure it.

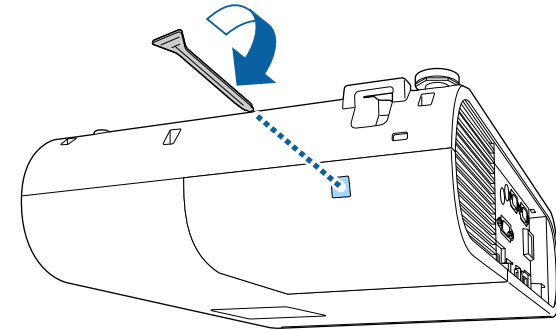

- Make sure the lamp cover is securely installed or the lamp will not turn on.
- Do not replace the lamp cover with too much force and make sure the lamp cover is not deformed.

Reset the lamp timer to zero to monitor the new lamp's usage.

► **Related Links**

- "Replacement Parts" [p.183](#)

Resetting the Lamp Timer

You must reset the lamp timer after replacing the projector's lamp to clear the lamp replacement message and to monitor lamp usage correctly.



Do not reset the lamp timer if you have not replaced the lamp to avoid inaccurate lamp usage information.

- 1** Turn on the projector.

- 2 Press the [Menu] button, select the **Reset** menu, and press [Enter].

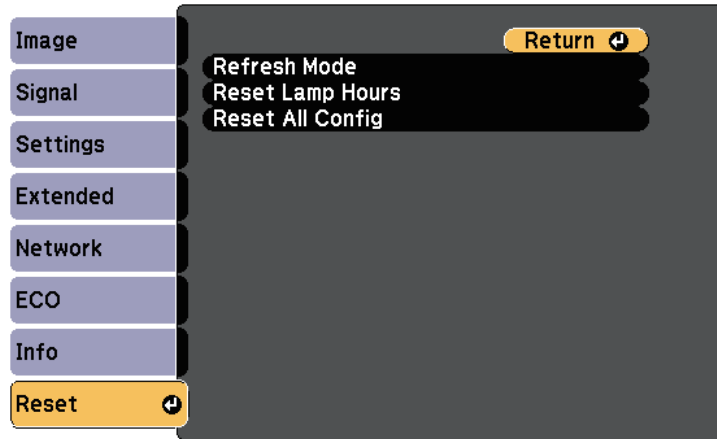

- 3 Select **Reset Lamp Hours** and press [Enter].
You see a prompt asking if you want to reset the lamp hours.
- 4 Select **Yes** and press [Enter].
- 5 Press [Menu] or [Esc] to exit the menus.

Solving Problems

Check the solutions in these sections if you have any problems using the projector.

► Related Links

- "Projection Problems" [p.165](#)
- "Projector Indicator Status" [p.166](#)
- "Using the Projector Help Displays" [p.169](#)
- "Solving Image or Sound Problems" [p.170](#)
- "Solving Projector or Remote Control Operation Problems" [p.176](#)
- "Solving Network Problems" [p.178](#)
- "Solutions to Problems in Content Playback mode" [p.180](#)

If the projector is not working properly, turn it off, unplug it, and then plug it back in and turn it on.

If this does not solve the problem, check the following:

- The indicators on the projector may indicate the problem.
- The projector's Help system can display information about common problems.
- The solutions in this manual can help you solve many problems.

If none of these solutions help, contact Epson for technical support.

The indicators on the projector indicate the projector status and let you know when a problem occurs. Check the status and color of the indicators and then refer to this table for a solution.

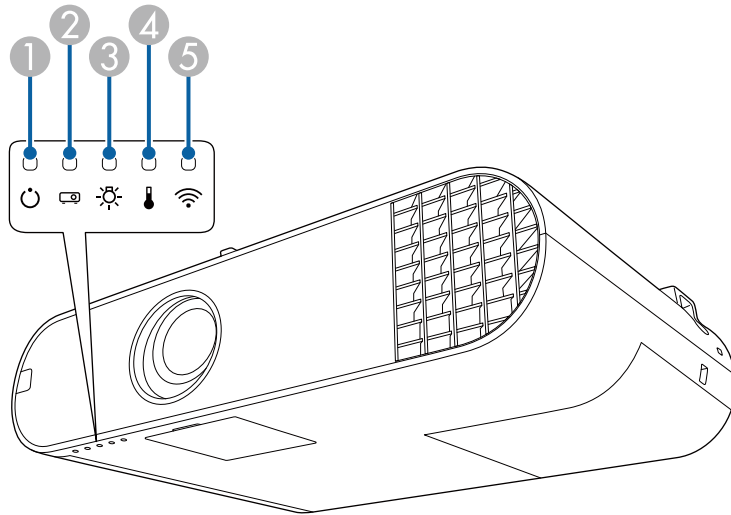

 • If the indicators display a pattern not listed in the table below, turn the projector off, unplug it, and contact Epson for help.



- ① Power indicator
- ② Status indicator
- ③ Lamp indicator
- ④ Temp (temperature) indicator
- ⑤ Wireless LAN indicator (EB-U50)

Projector status

| Indicator and status | Problem and solutions |
|---|---|
| Power: Lit blue Status: Lit blue Lamp: Off Temp: Off | Normal operation. |
| Power: Lit blue Status: Flashing blue Lamp: Off Temp: Off | Warming up or shutting down. When warming up, wait about 30 seconds for an image to appear. All buttons are disabled during warm-up and shutting down. |
| Power: Lit blue Status: Off Lamp: Off Temp: Off | Standby, sleep mode, or monitoring. When you press the power button, projection starts. |
| Power: Flashing blue Status: Off Lamp: Off Temp: Off | Preparing for monitoring and all features are disabled. |
| Power: Lit blue Status: Flashing blue Lamp: Off Temp: Off | Cooling down; all buttons are disabled. |
| Power: Indicator status varies Status: Flashing blue Lamp: Flashing orange Temp: Indicator status varies | Refresh Mode is in progress.  Reset > Refresh Mode |

| Indicator and status | Problem and solutions |
|---|---|
| Power: Flashing blue Status: Indicator status varies Lamp: Indicator status varies Temp: Flashing orange | Projector is too hot. <ul style="list-style-type: none"> • Make sure that the vents and air filter are not clogged with dust or obstructed by nearby objects. • Clean or replace the air filter. • Make sure the environmental temperature is not too hot. |
| Power: Off Status: Flashing blue Lamp: Off Temp: Lit orange | Projector has overheated and turned off. Leave it turned off to cool down for 5 minutes. <ul style="list-style-type: none"> • Make sure that the vents and air filter are not clogged with dust or obstructed by nearby objects. • Make sure the environmental temperature is not too hot. • Clean or replace the air filter. • If operating the projector at high altitude, set the High Altitude Mode setting to On in the projector menu.  Extended > Operation > High Altitude Mode • If the problem persists, unplug the projector and contact Epson for help. |
| Power: Off Status: Flashing blue Lamp: Lit orange Temp: Off | Lamp has a problem. <ul style="list-style-type: none"> • Check to see if the lamp is burned out, broken, or installed incorrectly. Reseat or replace the lamp as necessary. • Clean the air filter. • If operating the projector at high altitude, set the High Altitude Mode setting to On in the projector's menu.  Extended > Operation > High Altitude Mode • If the problem persists, unplug the projector and contact Epson for help. Lamp cover has a problem. <ul style="list-style-type: none"> • Check that the lamp and the lamp cover are securely installed. The lamp does not turn on if the lamp and the lamp cover are not installed correctly. |

| Indicator and status | Problem and solutions |
|---|---|
| Power: Flashing blue Status: Indicator status varies Lamp: Flashing orange Temp: Indicator status varies | Replace the lamp soon to avoid damage. Do not continue using the projector. |
| Power: Off Status: Flashing blue Lamp: Off Temp: Flashing orange | A fan or sensor has a problem. Turn the projector off, unplug it, and contact Epson for help. |
| Power: Off Status: Flashing blue Lamp: Flashing orange Temp: Off | Internal projector error. Turn the projector off, unplug it, and contact Epson for help. |
| Power: Off Status: Flashing blue Lamp: Flashing orange Temp: Flashing orange | Auto iris error. Turn the projector off, unplug it, and contact Epson for help. |
| Power: Off Status: Flashing blue Lamp: Lit orange Temp: Lit orange | Power error (Ballast). Turn the projector off, unplug it, and contact Epson for help. |

Wireless LAN status

| Wireless LAN indicator status | Problem and solutions |
|-------------------------------|---|
| Lit blue | Wireless LAN is available. |
| Flashing blue (quickly) | Connecting to a device. |
| Flashing blue (slowly) | An error has occurred. Turn off the projector and restart it. |

| | |
|-------------------------------|---|
| Wireless LAN indicator status | Problem and solutions |
| Off | Wireless LAN is not available. Make sure the wireless LAN settings are correct. |

» Related Links

- "Cleaning the Air Filter and Vents" [p.156](#)
- "Replacing the Air Filter" [p.158](#)
- "Replacing the Lamp" [p.160](#)

You can display information to help you solve common problems using the projector's Help system.

- 1 Turn on the projector.
- 2 Press the [Home] button on the remote control.

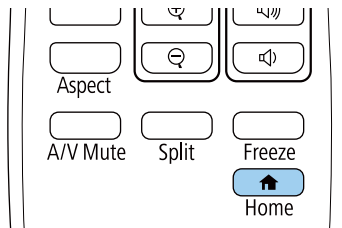

- 3 Select **Help** on the Home screen.



The Help menu is displayed.

- 4 Use the up and down arrow buttons to highlight the problem you want to solve.

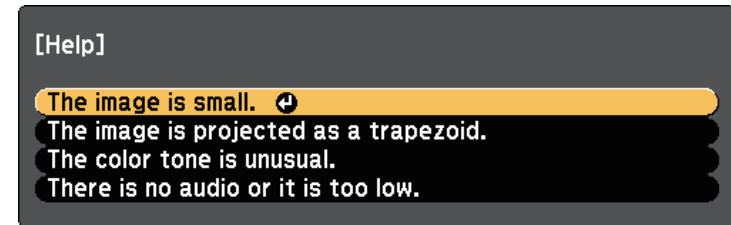

- 5 Press [Enter] to view the solutions.
- 6 Perform one of the following actions when you are finished.
 - To select another problem to solve, press [Esc].
 - To exit the help system, press [Menu].

Check the solutions in these sections if you have any problems with projected images or sound.

► Related Links

- "Solutions When No Image Appears" [p.170](#)
- "Solutions When Image is Incorrect Using the USB Display Function" [p.170](#)
- "Solutions When "No Signal" Message Appears" [p.171](#)
- "Solutions When "Not Supported" Message Appears" [p.171](#)
- "Solutions When Only a Partial Image Appears" [p.172](#)
- "Solutions When the Image is not Rectangular" [p.172](#)
- "Solutions When the Image Contains Noise or Static" [p.172](#)
- "Solutions When the Image is Fuzzy or Blurry" [p.173](#)
- "Solutions When the Image Brightness or Colors are Incorrect" [p.173](#)
- "Solutions When an Afterimage Remains on the Projected Image" [p.174](#)
- "Solutions to Sound Problems" [p.174](#)
- "Solutions When Image File Names are not Displayed Correctly in PC Free" [p.175](#)

Solutions When No Image Appears

If no image appears, try the following solutions:

- Press the [A/V Mute] button on the remote control to see if the image was temporarily turned off.
- Make sure all necessary cables are securely connected and the power is on for the projector and connected video sources.
- Press the projector's power button to wake it from standby or sleep mode. Also, check if the connected computer is in sleep mode or displaying a blank screen saver.
- Adjust the **Brightness** setting in the projector's **Image** menu.
- Select **Normal** as the **Power Consumption** setting.
 - ☛ **ECO > Power Consumption**
- Check the **Display** setting in the projector's **Extended** menu to make sure **Messages** is set to **On**.

- For images projected with Windows Media Center, reduce the screen size from full screen mode.
- For images projected from applications using Windows DirectX, turn off DirectX functions.
- The projector may not be able to project copyrighted videos that you play back on a computer. For more details, see the manual supplied with the computer.

► Related Links

- "Input Signal Settings - Signal Menu" [p.130](#)
- "Image Quality Settings - Image Menu" [p.128](#)
- "Projector Setup Settings - ECO Menu" [p.144](#)
- "Projector Setup Settings - Extended Menu" [p.133](#)

Solutions When Image is Incorrect Using the USB Display Function

If no image appears or if the image appears incorrectly using the USB Display function, try the following solutions:

- Press the [USB] button on the remote control.
- Make sure the Epson USB Display software has been installed correctly. Depending on your OS or computer settings, the software may not have been installed automatically. Download the latest software from the following Web site and install it.
<http://www.epson.com/>
- For Mac, select the **USB Display** icon in the **Dock** folder. If the icon does not appear on the **Dock**, double-click **USB Display** in the **Applications** folder.
 - If you select **Exit** from the **USB Display** icon menu on the **Dock**, USB Display does not start automatically when you connect the USB cable.
- For images projected with Windows Media Center, reduce the screen size from full screen mode.
- For images projected from applications using Windows DirectX, turn off DirectX functions.

- If the mouse cursor flickers, select **Make the movement of the mouse pointer smooth** in the **Epson USB Display Settings** program on your computer.
 - Turn off the **Transfer layered window** setting in the **Epson USB Display Settings** program on your computer.
 - For projectors with a resolution of WUXGA (1920 × 1200), if you change the computer resolution during projection, the performance and quality of the video may decline.
- » **Related Links**
- "Connecting to a Computer for USB Video and Audio" [p.21](#)

Solutions When "No Signal" Message Appears

If the "No Signal" message appears, try the following solutions:

- Press the [Source Search] button and wait a few seconds for an image to appear.
- Turn on the connected computer or video source, and press play to begin your presentation, if necessary.
- Check that all cables required for projection are securely connected.
- If you are projecting from a laptop computer, make sure it is set up to display on an external monitor.
- If necessary, turn off the projector and the connected computer or video source, and then turn them back on.
- If you are projecting from an HDMI source, replace the HDMI cable with the shorter one.

» **Related Links**

- "Displaying From a Laptop" [p.171](#)
- "Displaying From a Mac Laptop" [p.171](#)

Displaying From a Laptop

If the message "No Signal" is displayed when projecting from a laptop, you need to set up the laptop to display on an external monitor.

- 1** Hold down the laptop's **Fn** key and press the key labeled with a monitor icon or **CRT/LCD**. (See your laptop manual for details.) Wait a few seconds for an image to appear.
- 2** To display on the laptop's monitor and the projector, try pressing the same keys again.
- 3** If the same image is not displayed by the laptop and projector, check the Windows **Display** utility to make sure the external monitor port is enabled and extended desktop mode is disabled. (See your computer or Windows manual for instructions.)
- 4** If necessary, check your video card settings and set the multiple display option to **Clone** or **Mirror**.

Displaying From a Mac Laptop

If the message "No Signal" is displayed when projecting from a Mac laptop, you need to set up the laptop for mirrored display. (See your laptop manual for details.)

- 1** Open the **System Preferences** utility and select **Displays**.
- 2** Select the **Display** or **Color LCD** option, if necessary.
- 3** Click the **Arrange** or **Arrangement** tab.
- 4** Select **Mirror Displays**.

Solutions When "Not Supported" Message Appears

If the message "Not supported" is displayed, try the following solutions:

- Make sure the correct input signal is selected in the projector's **Signal** menu.

- Make sure the computer's display resolution does not exceed the projector's resolution and frequency limits. If necessary, select a different display resolution for your computer. (See your computer manual for details.)

» Related Links

- "Input Signal Settings - Signal Menu" [p.130](#)
- "Supported Monitor Display Resolutions" [p.187](#)

Solutions When Only a Partial Image Appears

If only a partial computer image appears, try the following solutions:

- If you are projecting from a computer using a VGA computer cable, press the [Auto] button on the remote control to optimize the image signal.
- Make sure the **Scale** setting in the **Signal** menu is turned off.
- Try adjusting the image position using the **Position** setting in the projector's **Signal** menu.
- Press the [Aspect] button on the remote control to select a different image aspect ratio.
- Change the **Resolution** setting in the projector's **Signal** menu according to the signal for the connected equipment.
- Try adjusting the image position using the **Image Shift** setting in the projector's **Settings** menu.
- Check your computer display settings to disable dual display and set the resolution within the projector's limits. (See your computer manual for details.)
- Check the resolution assigned to your presentation files to see if they are created for a different resolution. (See your software help for details.)
- Make sure you selected the correct projection mode. You can select this using the **Projection** setting in the projector's **Extended** menu.
- When projecting in Content Playback mode, make sure you are using the appropriate **Overlay Effect** settings.
 - ☛ **Settings > Content Playback > Overlay Effect**

» Related Links

- "Input Signal Settings - Signal Menu" [p.130](#)
- "Projector Setup Settings - Extended Menu" [p.133](#)
- "Supported Monitor Display Resolutions" [p.187](#)
- "Adding Effects to Your Projected Image" [p.66](#)

Solutions When the Image is not Rectangular

If the projected image is not evenly rectangular, try the following solutions:

- Place the projector directly in front of the center of the screen, facing it squarely, if possible.
- Set **Auto V-Keystone** to **On** in the projector's **Settings** menu. The projector automatically corrects the image every time you move the projector.
 - ☛ **Settings > Keystone > H/V-Keystone > Auto V-Keystone**
- Press the [Keystone] buttons on the remote control to adjust the image shape.
- Adjust the Quick Corner setting to correct the image shape.
 - ☛ **Settings > Keystone > Quick Corner**

» Related Links

- "Auto V-Keystone" [p.42](#)
- "Correcting the Image Shape with the Keystone Button" [p.42](#)
- "Correcting the Image Shape with Quick Corner" [p.43](#)

Solutions When the Image Contains Noise or Static

If the projected image contains electronic interference (noise) or static, try the following solutions:

- Check the cables connecting your computer or video source to the projector. They should be:
 - Separated from the power cord to prevent interference
 - Securely connected at both ends
 - Not connected to an extension cable

- Check the settings in the projector's **Signal** menu to make sure they match the video source.
- If available for your video source, adjust the **Deinterlacing** and **Noise Reduction** settings in the projector's **Image** menu.
 - ☛ **Image** > **Image Enhancement** > **Noise Reduction**
 - ☛ **Image** > **Image Enhancement** > **Deinterlacing**
- Select a computer video resolution and refresh rate that are compatible with the projector.
- If you are projecting from a computer using a VGA computer cable, press the [Auto] button on the remote control to automatically adjust the **Tracking** and **Sync.** settings. If the images are not adjusted correctly, manually adjust the **Tracking** and **Sync.** settings in the projector's **Signal** menu.
- Select **Auto** as the **Resolution** setting in the projector's **Signal** menu.
- If you adjusted the image shape using the projector controls, try decreasing the **Sharpness** setting in the projector's **Image** menu to improve image quality.
- If you connected an extension power cable, try projecting without it to see if it caused interference in the signal.
- If you are using the USB Display function, turn off the **Transfer layered window** setting in the **Epson USB Display Settings** program on your computer.

► Related Links

- "Input Signal Settings - Signal Menu" [p.130](#)
- "Image Quality Settings - Image Menu" [p.128](#)
- "Supported Monitor Display Resolutions" [p.187](#)

Solutions When the Image is Fuzzy or Blurry

If the projected image is fuzzy or blurry, try the following solutions:

- Adjust the image focus.
- Clean the projector lens.



To avoid condensation on the lens after bringing the projector in from a cold environment, let the projector warm up to room temperature before using it.

- Position the projector close enough to the screen.
- Position the projector so the keystone adjustment angle is not so wide that it distorts the image.
- Adjust the **Sharpness** setting in the projector's **Image** menu to improve image quality.
- If you are projecting from a computer using a VGA computer cable, press the [Auto] button on the remote control to automatically adjust the tracking and sync. If any bands or overall blurriness remain, display a uniformly patterned image on the screen and manually adjust the **Tracking** and **Sync.** settings in the projector's **Signal** menu.
- If you are projecting from a computer, use a lower resolution or select a resolution that matches the projector's native resolution.

► Related Links

- "Auto V-Keystone" [p.42](#)
- "Input Signal Settings - Signal Menu" [p.130](#)
- "Image Quality Settings - Image Menu" [p.128](#)
- "Supported Monitor Display Resolutions" [p.187](#)
- "Focusing the Image Using the Focus Ring" [p.47](#)
- "Cleaning the Lens" [p.154](#)

Solutions When the Image Brightness or Colors are Incorrect

If the projected image is too dark or light, or the colors are incorrect, try the following solutions:

- Press the [Color Mode] button on the remote control to try different color modes for the image and environment.
- Check your video source settings.

- Adjust the available settings in the projector's **Image** menu for the current input source, such as **Brightness**, **Contrast**, **Tint**, and **Color Saturation**.
- Make sure you selected the correct **Input Signal** or **Video Range** setting in the projector's **Signal** menu, if available for your image source.
 - ☛ **Signal > Advanced > Input Signal**
 - ☛ **Signal > Advanced > Video Range**
- Make sure all the cables are securely connected to the projector and your video device. If you connected long cables, try connecting shorter cables.
- If you are using **ECO** as **Power Consumption**, try selecting **Normal**.
 - ☛ **ECO > Power Consumption**



At high altitudes or locations subject to high temperatures, the image may become darker and you may not be able to adjust the **Power Consumption** setting.

- Position the projector close enough to the screen.
 - If the image has been progressively darkening, you may need to replace the projector lamp soon.
- ▶ **Related Links**
- "Adjusting Image Quality (Color Mode)" [p.51](#)
 - "Input Signal Settings - Signal Menu" [p.130](#)
 - "Image Quality Settings - Image Menu" [p.128](#)
 - "Projector Setup Settings - ECO Menu" [p.144](#)

Solutions When an Afterimage Remains on the Projected Image

If you see an afterimage in the projected image, use the **Refresh Mode** feature to clear it. Select **Refresh Mode > Start** in the projector's **Reset** menu.

▶ **Related Links**

- "Projector Reset Options - Reset Menu" [p.148](#)

Solutions to Sound Problems

If there is no sound or the volume is too low or high, try the following solutions:

- Adjust the projector's volume settings.
- Press the [A/V Mute] button on the remote control to resume video and audio if they were temporarily stopped.
- Check your computer or video source to make sure the volume is turned up and the audio output is set for the correct source.
- Check the audio cable connections between the projector and your video source.
- If you do not hear sound from an HDMI source, set the connected device to PCM output.
- Make sure any connected audio cables are labeled "No Resistance".
- If you are using the USB Display function, turn on the **Output audio from the projector** setting in the **Epson USB Display Settings** program on your computer.
- Select the correct audio input in the **A/V Settings** setting in the projector's **Extended** menu.
- When you are connecting the projector to a Mac using an HDMI cable, make sure your Mac supports audio through the HDMI port. If not, you need to connect an audio cable.
- If you want to use a connected audio source when the projector is off, set the **Standby Mode** option to **Communication On** and make sure the **A/V Settings** options are set correctly in the projector's **Extended** menu.
 - ☛ **ECO > Standby Mode > Standby Mode**
- If the volume for the computer is set to the minimum while the projector is set to the maximum, the noise may be mixed. Turn up the computer's volume and turn down the projector's volume. (When you use Epson iProjection (Windows/Mac) or USB Display.)

▶ **Related Links**

- "Projector Connections" [p.20](#)
- "Projector Setup Settings - Extended Menu" [p.133](#)
- "Projector Setup Settings - ECO Menu" [p.144](#)

- "Controlling the Volume with the Volume Buttons" [p.53](#)

Solutions When Image File Names are not Displayed Correctly in PC Free

If any file names are longer than the display area or include unsupported symbols, the file names are shortened or changed in PC Free. Shorten or change the file name.

Check the solutions in these sections if you have problems operating the projector or remote control.

» Related Links

- "Solutions to Projector Power or Shut-Off Problems" [p.176](#)
- "Solutions to Problems with the Remote Control" [p.176](#)
- "Solutions to Password Problems" [p.177](#)
- "Solution When "The Battery that Saves Your Clock Settings is Running Low" Message Appears" [p.177](#)

Solutions to Projector Power or Shut-Off Problems

If the projector does not turn on when you press the power button or it turns off unexpectedly, try the following solutions:

- Make sure the power cord is securely connected to the projector and to a working electrical outlet.
- The power cord may be defective. Disconnect the cord and contact Epson for help.
- If the projector's lamp turns off unexpectedly, it may have entered sleep mode after a period of inactivity. Perform any operation to wake the projector. To turn off sleep mode, select **Off** as the **Sleep Mode** setting in the projector's **ECO** menu.
- If the projector's lamp turns off unexpectedly, the A/V mute timer may be enabled. To turn off the A/V mute timer, select **Off** as the **A/V Mute Timer** setting in the projector's **ECO** menu.
- If the projector's lamp turns off, the status indicator is flashing, and the temp (temperature) indicator is lit, the projector has overheated and turned off.
- If the power button on the remote control does not turn on the projector, check its batteries and make sure at least one of the remote receivers are available in the **Remote Receiver** setting in the projector's **Settings** menu.
- The cooling fans may run in standby status depending on the projector settings. Also, when the projector wakes from standby status, the fans may cause an unexpected noise. This is not a malfunction.

» Related Links

- "Projector Setup Settings - ECO Menu" [p.144](#)
- "Projector Indicator Status" [p.166](#)
- "Projector Feature Settings - Settings Menu" [p.131](#)

Solutions to Problems with the Remote Control

If the projector does not respond to remote control commands, try the following solutions:

- Check that the remote control batteries are installed correctly and have power. If necessary, replace the batteries.
- Make sure you are operating the remote control within the reception angle and range of the projector.
- Make sure the projector is not warming up or shutting down.
- Check to see if a button on the remote control is stuck down, causing it to enter sleep mode. Release the button to wake the remote control up.
- Strong fluorescent lighting, direct sunlight, or infrared device signals may be interfering with the projector's remote receivers. Dim the lights or move the projector away from the sun or interfering equipment.
- Make sure at least one of the remote receivers are available in the **Remote Receiver** setting in the projector's **Settings** menu.
- If the **Remote Receiver** setting is disabled, hold down the [Menu] button on the remote control for at least 15 seconds to reset the setting to its default.
- If you assigned an ID number to the projector to operate multiple projectors from the remote control, you may need to check or change the ID setting.
- Press the 0 (zero) button on the remote control while holding down the [ID] button. By selecting 0 on the remote control, you can operate all of the projectors regardless of the projector ID settings.
- If you lose the remote control, you can order another one from Epson.

» Related Links

- "Remote Control Operation" [p.29](#)
- "Projector Feature Settings - Settings Menu" [p.131](#)
- "Selecting the Projector You want to Operate" [p.74](#)

- "Installing Batteries in the Remote Control" [p.28](#)

Solutions to Password Problems

If you cannot enter or remember a password, try the following solutions:

- You may have turned on password protection without first setting a password. Try entering **0000** using the remote control.
- If you have entered an incorrect password too many times and see a message displaying a request code, write down the code and contact Epson for help. Provide the request code and proof of ownership for assistance in unlocking the projector.
- If you set a Epson Web Control password and forgot the user ID or password, try entering the following:
 - User ID: **EPSONWEB**
 - Default password: **admin**
- If you set a Remote password (in Epson Web Control) and forgot the user ID or password, try entering the following:
 - User ID: **EPSONREMOTE**
 - Default password: **guest**
- If you lose the remote control you cannot enter a password. Order a new one from Epson.

Solution When "The Battery that Saves Your Clock Settings is Running Low" Message Appears

If the message "The battery that saves your clock settings is running low." is displayed, contact Epson for help.

Check the solutions in these sections if you have problems using the projector on a network.

► Related Links

- "Solutions When Wireless Authentication Fails" [p.178](#)
- "Solutions When You Cannot Access the Projector Through the Web" [p.178](#)
- "Solutions When Network Alert E-Mails are not Received" [p.178](#)
- "Solutions When the Image Contains Static During Network Projection" [p.179](#)

Solutions When Wireless Authentication Fails

If you are having trouble with the authentication, try the following solutions:

- If the wireless settings are correct, but authentication fails, you may need to update the **Date & Time** settings on the projector's **Extended** menu.
 - ☛ **Extended** > **Operation** > **Date & Time**
- Check the **Security** settings in the projector's **Network** menu.
 - ☛ **Network** > **Network Configuration** > **Wireless LAN**

► Related Links

- "Projector Setup Settings - Extended Menu" [p.133](#)
- "Network Menu - Wireless LAN Menu" [p.138](#)

Solutions When You Cannot Access the Projector Through the Web

If you are unable to access the projector through a Web browser, make sure you are using the correct ID and password.

- For the user ID, enter **EPSONWEB**. (You cannot change the user ID.)
- For the password, enter the password set in the projector's **Network** menu. The default password is **admin**.
- Make sure you have access to the network the projector is on.

- If your Web browser is set up to connect via a proxy server, the **Epson Web Control** screen cannot be displayed. Make settings for a connection without using a proxy server.
- If you set **Standby Mode** to **Communication On** in the projector's menu in standby mode, make sure the network device is turned on. After turning on the network device, turn on the projector.
 - ☛ **ECO** > **Standby Mode** > **Standby Mode**



The user ID and password are case sensitive.

► Related Links

- "Network Menu - Basic Menu" [p.137](#)

Solutions When Network Alert E-Mails are not Received

If you do not receive an e-mail alerting you to problems with a projector over the network, try the following solutions:

- Make sure the projector is turned on and connected to the network correctly. (If an error shuts down the projector, the email may not be delivered.)
- Make sure you set up the projector e-mail alert settings correctly on the projector's network **Notifications** menu or in the network software.
- Set the **Standby Mode** setting to **Communication On** so that the network software can monitor the projector in standby mode.
 - ☛ **ECO** > **Standby Mode** > **Standby Mode**
 - Change the **Port** setting according to your network environment.
 - ☛ **ECO** > **Standby Mode** > **Port**

► Related Links

- "Network Menu - Notifications Menu" [p.141](#)
- "Projector Setup Settings - ECO Menu" [p.144](#)

Solutions When the Image Contains Static During Network Projection

If the projected image contains static during network projection, try the following solutions:

- Check for any obstacles between the access point, the computer, the mobile device, and the projector, and change their positions to improve communication.
- Make sure that the access point, the computer, the mobile device and the projector are not too far apart. Move them closer together and try to connect again.
- Check for interference from other equipment, such as a Bluetooth device or microwave. Move the interfering device farther away or expand your wireless bandwidth.
- Reduce the number of connected devices if the connection speed declines.

If you cannot play back a playlist correctly, try the following solutions:

- Make sure **Content Playback** is set to **On**.
 - ☛ **Settings > Content Playback > Content Playback**
- Make sure the USB flash drive contains a playlist. See the *Epson Projector Content Manager Operation Guide* for details on creating a playlist.
- Make sure the USB flash drive is directly connected to the projector. Do not use a multi-card reader or a USB hub to expand a USB port.
- If the USB flash drive is partitioned, you may not be able to play back playlists. Delete all of the partitions before saving the playlists on the USB flash drive.
- Do not share a playlist between projectors that are different in resolution. Color and shape effects added by using **Overlay Effect** may not be reproduced correctly.

- ☛ **Settings > Content Playback > Overlay Effect**

» **Related Links**

- "Projecting in Content Playback Mode" [p.63](#)
- "Projector Feature Settings - Settings Menu" [p.131](#)

Appendix

Check these sections for the technical specifications and important notices about your projector.

► **Related Links**

- "Optional Accessories and Replacement Parts" [p.182](#)
- "Screen Size and Projection Distance" [p.184](#)
- "Supported Monitor Display Resolutions" [p.187](#)
- "Projector Specifications" [p.189](#)
- "External Dimensions" [p.191](#)
- "USB Display System Requirements" [p.192](#)
- "List of Safety Symbols and Instructions" [p.193](#)
- "Glossary" [p.195](#)
- "Notices" [p.197](#)

The following optional accessories and replacement parts are available. Please purchase these products as and when needed.

The following list of optional accessories and replacement parts is current as of: April 2019.

Details of accessories are subject to change without notice and availability may vary depending on the country of purchase.

► Related Links

- "Screens" [p.182](#)
- "Cables" [p.182](#)
- "Mounts" [p.182](#)
- "For Wireless Connection" [p.182](#)
- "External Devices" [p.183](#)
- "Replacement Parts" [p.183](#)

Screens

80" portable screen ELPSC24

Portable roll-type screens. (aspect ratio 16:10)

50" portable screen ELPSC32

A compact screen that can be carried easily. (aspect ratio 4:3)

80" Mobile X-Type Screen ELPSC21

Portable X-type screens. (aspect ratio 16:9)

Multi Aspect Screen ELPSC26

Portable multi-aspect screen.

Cables

Computer cable ELPKC02 (1.8 m - for mini D-sub 15-pin/mini D-Sub 15pin)

Computer cable ELPKC09 (3 m - for mini D-sub 15-pin/mini D-Sub 15pin)

Computer cable ELPKC10 (20 m - for mini D-sub 15-pin/mini D-Sub 15pin)

Use when connecting to the Computer port.

Mounts

Ceiling mount ELPMB23

Use when installing the projector on a ceiling.

Ceiling mount/Floor stand ELPMB60

Use when installing the projector on a ceiling, a wall, or a floor.

Lighting Track Mount ELPMB61

Use when installing the projector on a lighting track.

Safety Wire Set ELPWR01

Use when connecting the projector to the installation mount to prevent the projector from falling down.

Ceiling pipe (450 mm) ELPFP13

Ceiling pipe (700 mm) ELPFP14

Use when installing the projector on a high ceiling.



Special expertise is required to suspend the projector from a ceiling. Contact Epson for help.

For Wireless Connection

Wireless LAN module ELPAP10 (EB-W50/EB-X50)

Use this to project images from a computer via a wireless communication. (Frequency band: 2.4 GHz)

External Devices

Document Camera ELPDC21/ELPDC13/ELPDC07

Use when projecting image such as books, OHP documents, or slides.

External Speaker ELPSP02

External self-powered speaker.

Replacement Parts

Lamp unit ELPLP97

Use as a replacement for used lamps.

Air filter ELPAF59

Use as a replacement for used air filters.

Check the table here to determine how far to place the projector from the screen based on the size of the projected image.

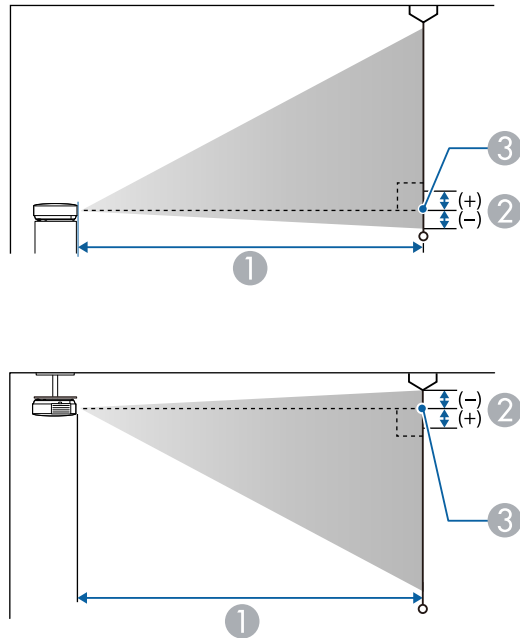

- ① Projection distance (cm)
- ② Distance from the center of the lens to the base of the screen (or to the top of the screen, if suspended from a ceiling) (cm)
- ③ Center of lens

WUXGA (EB-U50)

| 16:10 screen size | | ① | ② |
|-------------------|---------|----------------------------------|----|
| | | Minimum (Wide) to Maximum (Tele) | |
| 30" | 65 × 40 | 87 - 107 | -4 |
| 35" | 75 × 47 | 102 - 125 | -4 |

| 16:10 screen size | | ① | ② |
|-------------------|-----------|----------------------------------|-----|
| | | Minimum (Wide) to Maximum (Tele) | |
| 40" | 86 × 54 | 118 - 144 | -5 |
| 50" | 108 × 67 | 148 - 180 | -6 |
| 60" | 129 × 81 | 178 - 217 | -7 |
| 80" | 172 × 108 | 238 - 291 | -10 |
| 100" | 215 × 135 | 299 - 364 | -12 |
| 150" | 323 × 202 | 450 - 548 | -18 |
| 200" | 431 × 269 | 601 - 731 | -24 |
| 300" | 646 × 404 | 902 | -37 |

| 4:3 screen size | | ① | ② |
|-----------------|-----------|----------------------------------|-----|
| | | Minimum (Wide) to Maximum (Tele) | |
| 27" | 55 × 41 | 89 - 109 | -4 |
| 30" | 61 × 46 | 99 - 121 | -4 |
| 40" | 81 × 61 | 133 - 163 | -6 |
| 50" | 102 × 76 | 168 - 205 | -7 |
| 60" | 122 × 91 | 202 - 246 | -8 |
| 70" | 142 × 107 | 236 - 288 | -10 |
| 80" | 163 × 122 | 270 - 329 | -11 |
| 100" | 203 × 152 | 339 - 412 | -14 |
| 150" | 305 × 229 | 509 - 620 | -21 |
| 200" | 406 × 305 | 680 - 828 | -28 |
| 260" | 528 × 396 | 885 - 1078 | -36 |

| 16:9 screen size | | ① | ② |
|------------------|-----------|----------------------------------|-----|
| | | Minimum (Wide) to Maximum (Tele) | |
| 30" | 66 × 37 | 90 - 110 | -2 |
| 35" | 77 × 44 | 105 - 129 | -2 |
| 40" | 89 × 50 | 121 - 148 | -2 |
| 50" | 111 × 62 | 152 - 185 | -3 |
| 60" | 133 × 75 | 183 - 223 | -3 |
| 70" | 155 × 87 | 214 - 261 | -4 |
| 80" | 177 × 100 | 245 - 299 | -5 |
| 100" | 221 × 125 | 307 - 374 | -6 |
| 150" | 332 × 187 | 462 - 563 | -8 |
| 200" | 443 × 249 | 617 - 752 | -11 |
| 290" | 642 × 361 | 897 - 1091 | -16 |

| 4:3 screen size | | ① | ② |
|-----------------|-----------|----------------------------------|-----|
| | | Minimum (Wide) to Maximum (Tele) | |
| 29" | 59 × 44 | 90 - 109 | -4 |
| 30" | 61 × 46 | 94 - 113 | -4 |
| 40" | 81 × 61 | 126 - 152 | -5 |
| 50" | 102 × 76 | 158 - 190 | -7 |
| 60" | 122 × 91 | 190 - 229 | -8 |
| 70" | 142 × 107 | 222 - 267 | -10 |
| 80" | 163 × 122 | 255 - 306 | -11 |
| 100" | 203 × 152 | 319 - 383 | -14 |
| 150" | 305 × 229 | 480 - 577 | -20 |
| 200" | 406 × 305 | 641 - 770 | -27 |
| 280" | 569 × 427 | 898 - 1079 | -38 |

WXGA (EB-W50)

| 16:10 screen size | | ① | ② |
|-------------------|-----------|----------------------------------|-----|
| | | Minimum (Wide) to Maximum (Tele) | |
| 33" | 71 × 44 | 91 - 110 | -4 |
| 35" | 75 × 47 | 97 - 117 | -4 |
| 40" | 86 × 54 | 111 - 134 | -5 |
| 50" | 108 × 67 | 139 - 168 | -6 |
| 60" | 129 × 81 | 168 - 202 | -7 |
| 80" | 172 × 108 | 225 - 270 | -10 |
| 100" | 215 × 135 | 281 - 338 | -12 |
| 150" | 323 × 202 | 424 - 509 | -18 |
| 200" | 431 × 269 | 566 - 680 | -24 |
| 320" | 689 × 431 | 907 - 1089 | -39 |

| 16:9 screen size | | ① | ② |
|------------------|-----------|----------------------------------|-----|
| | | Minimum (Wide) to Maximum (Tele) | |
| 32" | 71 × 40 | 91 - 109 | -2 |
| 35" | 77 × 44 | 99 - 120 | -2 |
| 40" | 89 × 50 | 114 - 137 | -2 |
| 50" | 111 × 62 | 143 - 172 | -3 |
| 60" | 133 × 75 | 172 - 208 | -3 |
| 70" | 155 × 87 | 202 - 243 | -4 |
| 80" | 177 × 100 | 231 - 278 | -4 |
| 100" | 221 × 125 | 289 - 348 | -5 |
| 150" | 332 × 187 | 435 - 523 | -8 |
| 200" | 443 × 249 | 582 - 699 | -11 |
| 310" | 686 × 386 | 903 - 1084 | -17 |

XGA (EB-X50)

| 4:3 screen size | | ① | ② |
|-----------------|-----------|----------------------------------|-----|
| | | Minimum (Wide) to Maximum (Tele) | |
| 30" | 61 × 46 | 89 - 107 | -5 |
| 40" | 81 × 61 | 119 - 143 | -7 |
| 50" | 102 × 76 | 150 - 180 | -8 |
| 60" | 122 × 91 | 180 - 217 | -10 |
| 80" | 163 × 122 | 241 - 290 | -14 |
| 100" | 203 × 152 | 302 - 363 | -17 |
| 150" | 305 × 229 | 454 - 546 | -25 |
| 200" | 406 × 305 | 607 - 729 | -34 |
| 250" | 508 × 381 | 759 - 912 | -42 |
| 300" | 610 × 457 | 912 - 1095 | -51 |

| 16:10 screen size | | ① | ② |
|-------------------|-----------|----------------------------------|-----|
| | | Minimum (Wide) to Maximum (Tele) | |
| 29" | 62 × 39 | 91 - 110 | -1 |
| 30" | 65 × 40 | 94 - 113 | -1 |
| 40" | 86 × 54 | 126 - 152 | -2 |
| 50" | 108 × 67 | 159 - 191 | -2 |
| 60" | 129 × 81 | 191 - 230 | -3 |
| 80" | 172 × 108 | 256 - 307 | -4 |
| 100" | 215 × 135 | 320 - 385 | -4 |
| 150" | 323 × 202 | 482 - 579 | -7 |
| 200" | 431 × 269 | 643 - 773 | -9 |
| 250" | 538 × 337 | 805 - 967 | -11 |
| 280" | 603 × 377 | 902 - 1083 | -13 |

| 16:9 screen size | | ① | ② |
|------------------|-----------|----------------------------------|---|
| | | Minimum (Wide) to Maximum (Tele) | |
| 28" | 62 × 35 | 90 - 109 | 1 |
| 30" | 66 × 37 | 97 - 117 | 1 |
| 40" | 89 × 50 | 130 - 156 | 1 |
| 50" | 111 × 62 | 163 - 196 | 1 |
| 60" | 133 × 75 | 196 - 236 | 1 |
| 80" | 177 × 100 | 263 - 316 | 2 |
| 100" | 221 × 125 | 329 - 396 | 2 |
| 150" | 332 × 187 | 495 - 595 | 3 |
| 200" | 443 × 249 | 661 - 794 | 5 |
| 250" | 553 × 311 | 827 - 994 | 6 |
| 275" | 609 × 342 | 910 - 1093 | 6 |

The tables here list the compatible refresh rate and resolution for each compatible video display format.

Component Signals (Analog RGB)

| Signal | Refresh rate (Hz) | Resolution (dots) |
|-----------------------------|-------------------|-------------------|
| VGA | 60/72/75/85 | 640 × 480 |
| SVGA | 60/72/75/85 | 800 × 600 |
| XGA | 60/70/75/85 | 1024 × 768 |
| WXGA | 60 | 1280 × 768 |
| | 60 | 1366 × 768 |
| | 60/75/85 | 1280 × 800 |
| WXGA+ | 60/75/85 | 1440 × 900 |
| WXGA++ | 60 | 1600 × 900 |
| SXGA | 70/75/85 | 1152 × 864 |
| | 60/75/85 | 1280 × 960 |
| | 60/75/85 | 1280 × 1024 |
| SXGA+ | 60/75 | 1400 × 1050 |
| WSXGA+ * | 60 | 1680 × 1050 |
| UXGA | 60 | 1600 × 1200 |
| WUXGA (Reduced Blanking) ** | 60 | 1920 × 1200 |

* Available only for EB-U50/EB-W50 and compatible only when **Wide** is selected as the **Resolution** setting in the projector's **Signal** menu.

** Available only for EB-U50.

Even when signals other than those mentioned above are input, it is likely that the image can be projected. However, not all functions may be supported.

Component Video

| Signal | Refresh rate (Hz) | Resolution (dots) |
|------------------|-------------------|-------------------|
| SDTV (480i/480p) | 59.94 | 720 × 480 |
| SDTV (576i/576p) | 50 | 720 × 576 |
| HDTV (720p) | 50/59.94/60 | 1280 × 720 |
| HDTV (1080i) | 50/59.94/60 | 1920 × 1080 |

HDMI Port Input Signals

| Signal | Refresh rate (Hz) | Resolution (dots) |
|-----------------------------|-------------------|-------------------|
| VGA | 60 | 640 × 480 |
| SVGA | 60 | 800 × 600 |
| XGA | 60 | 1024 × 768 |
| WXGA | 60 | 1280 × 800 |
| | 60 | 1366 × 768 |
| WXGA+ | 60 | 1440 × 900 |
| WXGA++ | 60 | 1600 × 900 |
| SXGA | 60 | 1280 × 960 |
| | 60 | 1280 × 1024 |
| SXGA+ | 60 | 1400 × 1050 |
| WSXGA+ * | 60 | 1680 × 1050 |
| UXGA | 60 | 1600 × 1200 |
| 1920 × 1080 | 50/60 | 1920 × 1080 |
| WUXGA (Reduced Blanking) ** | 60 | 1920 × 1200 |
| SDTV (480i/480p) | 59.94 | 720 × 480 |
| SDTV (576i/576p) | 50 | 720 × 576 |
| HDTV (720p) | 50/59.94/60 | 1280 × 720 |
| HDTV (1080i) | 50/59.94/60 | 1920 × 1080 |

| Signal | Refresh rate (Hz) | Resolution (dots) |
|--------------|-------------------------------|-------------------|
| HDTV (1080p) | 23.98/24/29.97/30/50/59.94/60 | 1920 × 1080 |

* Available only for EB-U50/EB-W50.

** Available only for EB-U50.

| | |
|---------------------------------------|---|
| Product name | EB-U50/EB-W50/EB-X50 |
| Dimensions | 364 (W) × 87 (H) × 248 (D) mm (not including raised section) |
| LCD panel size | EB-U50: 0.67" EB-W50: 0.59" EB-X50: 0.55" |
| Display method | Poly-silicon TFT active matrix |
| Resolution | EB-U50: 2,304,000 pixels WUXGA (1,920 (W) × 1,200 (H) dots) × 3 EB-W50: 1,024,000 pixels WXGA (1,280 (W) × 800 (H) dots) × 3 EB-X50: 786,432 pixels XGA (1,024 (W) × 768 (H) dots) × 3 |
| Focus adjustment | Manual |
| Zoom adjustment | 1 to 1.2 (Optical Zoom) |
| Lamp | UHE lamp, 200 W Model No.: ELPLP97 |
| Lamp life | Normal Power Consumption mode: Up to 10,000 hours ECO Power Consumption mode: Up to 17,000 hours |
| Max. audio output | 5 W |
| Speaker | 1 |
| Power supply | 100-240V AC±10% 50/60Hz 2.9 - 1.3 A |
| Power consumption (100 to 120 V area) | Operating: 298 W |
| Power consumption (220 to 240 V area) | Operating: 285 W |

| | |
|---------------------------|---|
| Standby power consumption | Communication On: 2.0 W Communication Off: 0.3 W |
| Operating altitude | Altitude 0 to 3,048 m |
| Operating temperature * | Altitude of 0 to 2,286 m: +5 to +40°C (No condensation) Altitude of 2,287 to 3,048 m: +5 to +35°C (Humidity of 20 to 80%, No condensation) |
| Storage temperature | -10 to +60°C (Humidity of 10 to 90%, No condensation) |
| Mass | EB-U50: Approx. 3.1 kg EB-W50/EB-X50: Approx. 3.0 kg |

* Lamp brightness automatically dims if the surrounding temperature gets too high. (Approximately 35°C at an altitude of 0 to 2,286 m, and approximately 30°C at an altitude of 2,287 to 3,048 m; however, this may vary depending on the surrounding environment.)

This product is also designed for IT power distribution system with phase-to-phase voltage 230V.

Angle of tilt

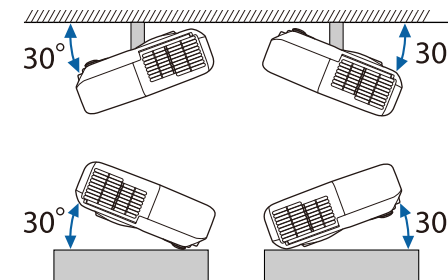

If you use the projector tilted at an angle of more than 30° it could be damaged and cause an accident.

► Related Links

- "Connector Specifications" [p.190](#)

Connector Specifications

| | | |
|--------------------|---|---------------------------------------|
| Computer1 port | 1 | Mini D-Sub15-pin (female) |
| Computer2 port | 1 | Mini D-Sub15-pin (female) |
| Monitor Out port | 1 | Mini D-Sub15-pin (female) |
| Audio 1 port | 1 | Stereo mini pin jack |
| Audio 2 port | 1 | Stereo mini pin jack |
| Audio Out port | 1 | Stereo mini pin jack |
| HDMI1, HDMI2 ports | 2 | HDMI (Audio is only supported by PCM) |
| USB-A port | 1 | USB connector (Type A) |
| USB-B port | 1 | USB connector (Type B) |
| LAN port | 1 | RJ-45 |
| RS-232C port | 1 | Mini D-Sub 9-pin (male) |



- USB-A and USB-B port supports USB 2.0. However, USB ports are not guaranteed to operate all devices that support USB.
- USB-B port does not support USB 1.1.

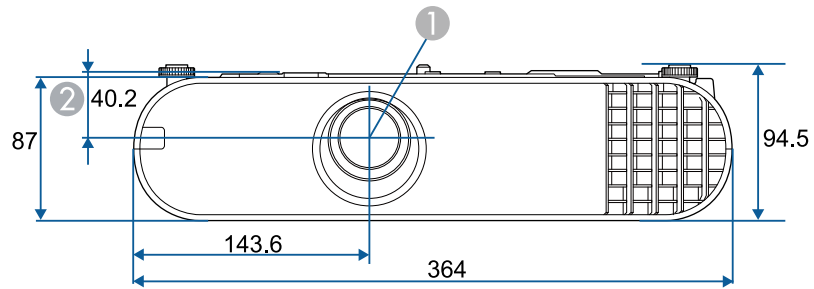

- ① Center of lens
- ② Distance from center of lens to suspension bracket fixing point

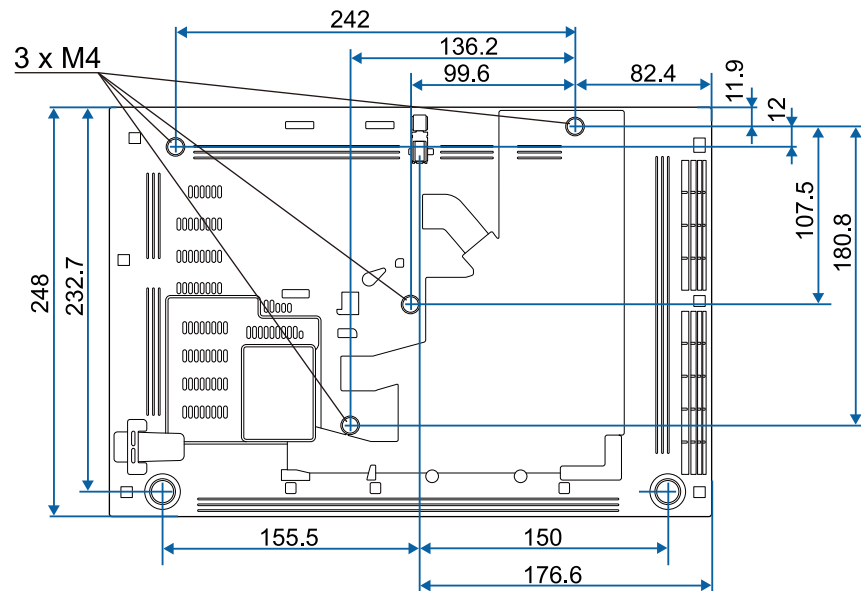

















The unit in these illustrations is mm.









To use the projector's Epson USB Display software, your computer must meet the following system requirements.

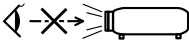

| Requirement | Windows | Mac |
|------------------|---|---|
| Operating system | Windows 7 <ul style="list-style-type: none"> • Ultimate (32- and 64-bit) • Enterprise (32- and 64-bit) • Professional (32- and 64-bit) • Home Premium (32- and 64-bit) • Home Basic (32-bit) • Starter (32-bit) | OS X <ul style="list-style-type: none"> • 10.8.x (64-bit) • 10.9.x (64-bit) • 10.10.x (64-bit) • 10.11.x (64-bit) |
| | Windows 8.1 <ul style="list-style-type: none"> • Windows 8.1 (32- and 64-bit) • Windows 8.1 Pro (32- and 64-bit) • Windows 8.1 Enterprise (32- and 64-bit) | macOS <ul style="list-style-type: none"> • 10.12.x (64-bit) • 10.13.x (64-bit) • 10.14.x (64-bit) |
| | Windows 10 <ul style="list-style-type: none"> • Windows 10 Home (32- and 64-bit) • Windows 10 Pro (32- and 64-bit) • Windows 10 Enterprise (32- and 64-bit) | |
| CPU | Intel Core2Duo or faster (Intel Core i3 or faster recommended) | Intel Core2Duo or faster (Intel Core i5 or faster recommended) |
| Memory | 2GB or more (4GB or more recommended) | |
| Hard disk space | 20 MB or more | |
| Display | Resolution between 640 × 480 and 1920 × 1200 16-bit color or greater | |

The following table lists the meaning of the safety symbols labeled on the equipment.

| No. | Symbol mark | Approved standards | Description |
|-----|---|---------------------------------------|---|
| 1 |  | IEC60417 No. 5007 | "ON" (power) To indicate connection to the mains. |
| 2 |  | IEC60417 No. 5008 | "OFF" (power) To indicate disconnection from the mains. |
| 3 |  | IEC60417 No. 5009 | Stand-by To identify the switch or switch position by means of which part of the equipment is switched on in order to bring it into the stand-by condition. |
| 4 |  | ISO7000 No. 0434B, IEC3864-B3.1 | Caution To identify general caution when using the product. |
| 5 |  | IEC60417 No. 5041 | Caution, hot surface To indicate that the marked item can be hot and should not be touched without taking care. |
| 6 |  | IEC60417 No. 6042 ISO3864-B3.6 | Caution, risk of electric shock To identify equipment that has risk of electric shock. |
| 7 |  | IEC60417 No. 5957 | For indoor use only To identify electrical equipment designed primarily for indoor use. |
| 8 |  | IEC60417 No. 5926 | Polarity of d.c. power connector To identify the positive and negative connections (the polarity) on a piece of equipment to which a d.c. power supply may be connected. |

| No. | Symbol mark | Approved standards | Description |
|-----|---|-----------------------|---|
| 9 |  | — | The same as No. 8. |
| 10 |  | IEC60417 No. 5001B | Battery, general On battery powered equipment. To identify a device for instance a cover for the battery compartment, or the connector terminals. |
| 11 |  | IEC60417 No. 5002 | Positioning of cell To identify the battery holder itself and to identify the positioning of the cell(s) inside the battery holder. |
| 12 |  | — | The same as No. 11. |
| 13 |  | IEC60417 No. 5019 | Protective earth To identify any terminal which is intended for connection to an external conductor for protection against electric shock in case of a fault, or the terminal of a protective earth electrode. |
| 14 |  | IEC60417 No. 5017 | Earth To identify an earth (ground) terminal in cases where neither the symbol No. 13 is explicitly required. |
| 15 |  | IEC60417 No. 5032 | Alternating current To indicate on the rating plate that the equipment is suitable for alternating current only; to identify relevant terminals. |
| 16 |  | IEC60417 No. 5031 | Direct current To indicate on the rating plate that the equipment is suitable for direct current only; to identify relevant terminals. |

| No. | Symbol mark | Approved standards | Description |
|-----|---|---------------------------------|--|
| 17 |  | IEC60417 No. 5172 | Class II equipment To identify equipment meeting the safety requirements specified for Class II equipment according to IEC 61140. |
| 18 |  | ISO 3864 | General prohibition To identify actions or operations that are prohibited. |
| 19 |  | ISO 3864 | Contact prohibition To indicate injury that could occur due to touching a specific part of the equipment. |
| 20 |  | — | Never look into the optical lens while the projector is on. |
| 21 |  | — | To indicate that the marked item don't place anything on projector. |
| 22 |  | ISO3864 IEC60825-1 | Caution, laser radiation To indicate the equipment has a laser radiation part. |
| 23 |  | ISO 3864 | Disassembly prohibition To indicate a risk of injury, such as electric shock, if the equipment is disassembled. |
| 24 |  | IEC60417 No. 5266 | Standby, partial standby To indicate that part of the equipment is in the ready status. |
| 25 |  | ISO3864 IEC60417 No. 5057 | Caution, movable parts To indicate that you must keep away from movable parts according to protection standards. |
| 26 |  | IEC60417 No. 6056 | Caution (Moving Fan Blades) As a safety precaution, stay away from the moving fan blades. |

| No. | Symbol mark | Approved standards | Description |
|-----|---|----------------------|--|
| 27 |  | IEC60417 No. 6043 | Caution (Sharp Corners) To indicate sharp corners that should not be touched. |
| 28 |  | — | To indicate that looking into the lens while projecting is prohibited. |

This section briefly explains the difficult terms that are not explained in the text of this guide. For details, refer to other commercially available publications.

| | |
|----------------------|--|
| AMX Device Discovery | AMX Device Discovery is a technology developed by AMX to facilitate AMX control systems for easy operation of the target equipment. Epson have implemented this protocol technology, and have provided a setting to enable the protocol function (ON). See the AMX Web site for more details. URL http://www.amx.com/ |
| Aspect Ratio | The ratio between an image's length and its height. Screens with a horizontal:vertical ratio of 16:9, such as HDTV screens, are known as wide screens. SDTV and general computer displays have an aspect ratio of 4:3. |
| Component Video | A method that separates the video signal into a luminance component (Y), and a blue minus luminance (Cb or Pb) and a red minus luminance (Cr or Pr). |
| Composite Video | A method that combines the video signal into a luminance component and a color component for transmission down a single cable. |
| Contrast | The relative brightness of the light and dark areas of an image can be increased or decreased to make text and graphics stand out more clearly, or to make them appear softer. Adjusting this particular property of an image is called contrast adjustment. |
| DHCP | An abbreviation of Dynamic Host Configuration Protocol, this protocol automatically assigns an IP address to equipment connected to a network. |
| Gateway Address | This is a server (router) for communicating across a network (subnet) divided according to subnet mask. |

| | |
|-------------|---|
| HDCP | HDCP is an abbreviation for High-bandwidth Digital Content Protection. It is used to prevent illegal copying and protect copyrights by encrypting digital signals sent over DVI and HDMI ports. Because the HDMI port on this projector supports HDCP, it can project digital images protected by HDCP technology. However, the projector may not be able to project images protected with updated or revised versions of HDCP encryption. |
| HDMI™ | An abbreviation for High Definition Multimedia Interface. HDMI™ is a standard aimed at digital consumer electronics and computers. This is the standard by which HD images and multichannel audio signals are digitally transmitted. By not compressing the digital signal, the image can be transferred at the highest quality possible. It also provides an encryption function for the digital signal. |
| HDTV | An abbreviation for High-Definition Television that refers to high-definition systems which satisfy the following conditions: <ul style="list-style-type: none"> • Vertical resolution of 720p or 1080i or greater (p = Progressive, i = Interlace) • Screen aspect ratio of 16:9 |
| Interlace | Transmits information needed to create one screen by sending every other line, starting from the top of the image and working down to the bottom. Images are more likely to flicker because one frame is displayed every other line. |
| IP Address | A number to identify a computer connected to a network. |
| Progressive | Projects information to create one screen at a time, displaying the image for one frame. Even though the number of scan lines is the same, the amount of flicker in images decreases because the volume of information has doubled compared with an interlace system. |

| | |
|--------------|---|
| Refresh Rate | <p>The light-emitting element of a display maintains the same luminosity and color for an extremely short time.</p> <p>Because of this, the image must be scanned many times per second to refresh the light-emitting element.</p> <p>The number of refresh operations per second is called the Refresh rate and is expressed in hertz (Hz).</p> |
| SDTV | An abbreviation for Standard Definition Television that refers to standard television systems which do not satisfy the conditions for HDTV High-Definition Television. |
| SNMP | An abbreviation for Simple Network Management Protocol, which is the protocol for monitoring and controlling devices such as routers and computers connected to a TCP/IP network. |
| sRGB | An international standard for color intervals that was formulated so that colors that are reproduced by video equipment can be handled easily by computer operating systems (OS) and the Internet. If the connected source has an sRGB mode, set both the projector and the connected signal source to sRGB. |
| SSID | SSID is identification data for connecting to another device on a wireless LAN. Wireless communication is possible between devices with the same SSID. |
| Subnet Mask | This is a numerical value that defines the number of bits used for the network address on a divided network (subnet) from the IP address. |
| SVGA | A screen size standard with a resolution of 800 (horizontal) × 600 (vertical) dots. |
| SXGA | A screen size standard with a resolution of 1,280 (horizontal) × 1,024 (vertical) dots. |
| Sync. | <p>The signals output from computers have a specific frequency.</p> <p>If the projector frequency does not match this frequency, the resulting images are not of a good quality.</p> <p>The process of matching the phases of these signals (the relative position of the crests and the troughs in the signal) is called Synchronization.</p> <p>If the signals are not synchronized, flickering, blurriness, and horizontal interference occur.</p> |

| | |
|-----------------|--|
| Tracking | <p>The signals output from computers have a specific frequency.</p> <p>If the projector frequency does not match this frequency, the resulting images are not of a good quality.</p> <p>The process of matching the frequency of these signals (the number of crests in the signal) is called Tracking.</p> <p>If Tracking is not carried out correctly, wide vertical stripes appear in the signal.</p> |
| Trap IP Address | This is the IP address for the destination computer used for error notification in SNMP. |
| VGA | A screen size standard with a resolution of 640 (horizontal) × 480 (vertical) dots. |
| XGA | A screen size standard with a resolution of 1,024 (horizontal) × 768 (vertical) dots. |
| WXGA | A screen size standard with a resolution of 1,280 (horizontal) × 800 (vertical) dots. |
| WUXGA | A screen size standard with a resolution of 1,920 (horizontal) × 1,200 (vertical) dots. |

Check these sections for important notices about your projector.

► **Related Links**

- "FCC Compliance Statement" [p.197](#)
- "Indication of the manufacturer and the importer in accordance with requirements of EU directive" [p.198](#)
- "Restriction of Use" [p.198](#)
- "Operating System References" [p.198](#)
- "Trademarks" [p.198](#)
- "Copyright Notice" [p.199](#)
- "Copyright Attribution" [p.199](#)

FCC Compliance Statement

Supplier's DECLARATION of CONFORMITY

According to 47CFR, Part 2 and 15
 Class B Personal Computers and Peripherals; and/or
 CPU Boards and Power Supplies used with Class B Personal Computers

We: Epson America, Inc.

Located at: 3840 Kilroy Airport Way Long Beach, CA 90806

Tel: 562-981-3840

Declare under sole responsibility that the product identified herein, complies with 47CFR Part 2 and 15 of the FCC rules as a Class B digital device. Each product marketed, is identical to the representative unit tested and found to be compliant with the standards. Records maintained continue to reflect the equipment being produced can be expected to be within the variation accepted, due to quantity production and testing on a statistical basis as required by 47CFR 2.906. Operation is subject to the following two conditions: (1) this device may not cause harmful interference, and (2) this device must accept any interface received, including interference that may cause undesired operation.

Trade Name: EPSON

Type of Product: LCD Projector

Model: H952C/H950C/H951C

Options:

| | |
|-------------------|--------------------|
| Product name | Model |
| Remote controller | 2197353 xx (x=0-9) |

FCC Compliance Statement For United States Users

This device complies with part 15 of the FCC Rules. Operation is subject to the following two conditions: (1) This device may not cause harmful interference, and (2) this device must accept any interference received, including interference that may cause undesired operation.

This equipment has been tested and found to comply with the limits for a Class B digital device, pursuant to Part 15 of the FCC Rules. These limits are designed to provide reasonable protection against harmful interference in a residential installation. This equipment generates, uses, and can radiate radio frequency energy and, if not installed and used in accordance with the instructions, may cause harmful interference to radio communications. However, there is no guarantee that interference will not occur in a particular installation. If this equipment does cause interference to radio and television reception, which can be determined by turning the equipment off and on, the user is encouraged to try to correct the interference by one or more of the following measures.

- Reorient or relocate the receiving antenna.
- Increase the separation between the equipment and receiver.
- Connect the equipment into an outlet on a circuit different from that to which the receiver is connected.
- Consult the dealer or an experienced radio/TV technician for help.

WARNING

The connection of a non-shielded equipment interface cable to this equipment will invalidate the FCC Certification or Declaration of this device and may cause interference levels which exceed the limits established by the FCC for this equipment. It is the responsibility of the user to obtain and use a shielded equipment interface cable with this device. If this equipment has more than one interface connector, do not leave cables connected to unused

interfaces. Changes or modifications not expressly approved by the manufacturer could void the user's authority to operate the equipment.

Statement for Canadian EMC Rules

CAN ICES-3 (B) / NMB-3 (B)

Indication of the manufacturer and the importer in accordance with requirements of EU directive

Manufacturer: SEIKO EPSON CORPORATION
Address: 3-5, Owa 3-chome, Suwa-shi, Nagano-ken 392-8502 Japan
Telephone: 81-266-52-3131
<http://www.epson.com/>

Importer: EPSON EUROPE B.V.
Address: Atlas Arena, Asia Building, Hoogoorddreef 5,1101 BA Amsterdam
Zuidoost
The Netherlands
Telephone: 31-20-314-5000
<http://www.epson.eu/>

Restriction of Use

When this product is used for applications requiring high reliability/safety such as transportation devices related to aviation, rail, marine, automotive etc.; disaster prevention devices; various safety devices etc; or functional/precision devices etc, you should use this product only after giving consideration to including fail-safes and redundancies into your design to maintain safety and total system reliability. Because this product was not intended for use in applications requiring extremely high reliability/safety such as aerospace equipment, main communication equipment, nuclear power control equipment, or medical equipment related to direct medical care

etc, please make your own judgment on this product's suitability after a full evaluation.

Operating System References

- Microsoft® Windows Vista® operating system
- Microsoft® Windows® 7 operating system
- Microsoft® Windows® 8 operating system
- Microsoft® Windows® 8.1 operating system
- Microsoft® Windows® 10 operating system

In this guide, the operating systems above are referred to as "Windows Vista", "Windows 7", "Windows 8", "Windows 8.1", and "Windows 10". Furthermore, the collective term "Windows" is used to refer to them all.

- OS X 10.7.x
- OS X 10.8.x
- OS X 10.9.x
- OS X 10.10.x
- OS X 10.11.x
- macOS 10.12.x
- macOS 10.13.x
- macOS 10.14.x

In this guide, the operating systems above are referred to as "OS X 10.7.x", "OS X 10.8.x", "OS X 10.9.x", "OS X 10.10.x", "OS X 10.11.x", "macOS 10.12.x", "macOS 10.13.x", and "macOS 10.14.x". Furthermore, the collective term "Mac" is used to refer to them all.

Trademarks

EPSON is a registered trademark, EXCEED YOUR VISION, ELPLP and their logos are registered trademarks or trademarks of Seiko Epson Corporation.

Mac, OS X, and macOS are trademarks of Apple Inc.

Microsoft, Windows, Windows Vista, and the Windows logo are trademarks or registered trademarks of Microsoft Corporation in the United States and/or other countries.

WPA™ and WPA2™ are registered trademarks of Wi-Fi Alliance.

App Store is a service mark of Apple Inc.

Chrome, Chromebook, and Google Play are trademarks of Google LLC.

HDMI and High-Definition Multimedia Interface are the trademarks or registered trademarks of HDMI Licensing LLC. 

"QR Code" is a registered trademark of DENSO WAVE INCORPORATED.

PJLink trademark is a trademark applied for registration or is already registered in Japan, the United States of America and other countries and areas.

Crestron®, Crestron Connected®, Crestron Fusion®, Crestron Control®, and Crestron RoomView® are registered trademarks of Crestron Electronics, Inc.

Art-Net™ Designed by and Copyright Artistic Licence Holdings Ltd.

Intel® is a registered trademark of Intel Corporation in the U.S. and/or other countries.

Wi-Fi™ is a trademark of the Wi-Fi Alliance.

Other product names used herein are also for identification purposes only and may be trademarks of their respective owners. Epson disclaims any and all rights in those marks.

expenses incurred by the purchaser or third parties as a result of: accident, misuse, or abuse of this product or unauthorized modifications, repairs, or alterations to this product, or (excluding the U.S.) failure to strictly comply with Seiko Epson Corporation's operating and maintenance instructions.

Seiko Epson Corporation shall not be liable against any damages or problems arising from the use of any options or any consumable products other than those designated as Original Epson Products or Epson Approved Products by Seiko Epson Corporation.

The contents of this guide may be changed or updated without further notice.

Illustrations in this guide and the actual projector may differ.

Copyright Attribution

This information is subject to change without notice.

©SEIKO EPSON CORPORATION 2019. All rights reserved.

2019.4 413781200EN

Copyright Notice

All rights reserved. No part of this publication may be reproduced, stored in a retrieval system, or transmitted in any form or by any means, electronic, mechanical, photocopying, recording, or otherwise, without the prior written permission of Seiko Epson Corporation. No patent liability is assumed with respect to the use of the information contained herein. Neither is any liability assumed for damages resulting from the use of the information contained herein.

Neither Seiko Epson Corporation nor its affiliates shall be liable to the purchaser of this product or third parties for damages, losses, costs, or